



GUTTER SYSTEM SEMICIRCULAR



PRICE LIST 2025

RECOMMENDED CONSUMER PRICES



POWERFUL PARTNER FOR YOUR ROOF



Aluminium material | 4



Gutter | 6

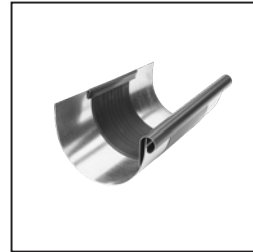

Gutter expanders | 9



Gutter accessories | 13



Gutter hook | 15



Corner | 18



End Cap | 20



Outlet | 21



Elbow | 32



Downpipe | 35



Downpipe accessories | 40



Pipe bracket | 42

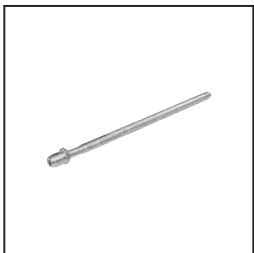

Pipe bracket accessories | 43



Downpipe flap | 45



Protective gutter pipe | 49



GUTTER SYSTEM SEMI CIRCULAR – CIRCULAR

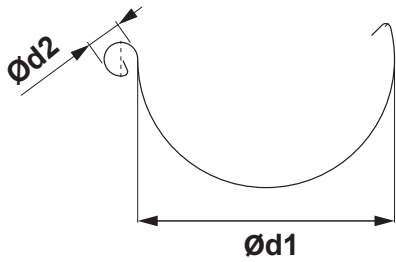

ROOF GUTTER DIMENSIONS

(dimensions and dimensional tolerances according to EN 612)

Developed width (mm)	200	250	280	333	400
Ød1	80	105	127	153	192
Ød2	16	18	18	20	22

INNER FALZ

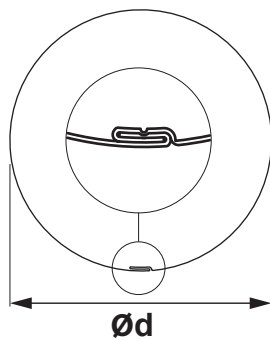

SPOUT PIPE DIMENSIONS

(dimensions and dimensional tolerances according to EN 612)

Dimensions	60	80	100	120	150
Nominal size Ød (mm)	60	80	100	120	150

GUTTER BRACKET DIMENSIONS

(dimensions and dimensional tolerances according to EN 612)

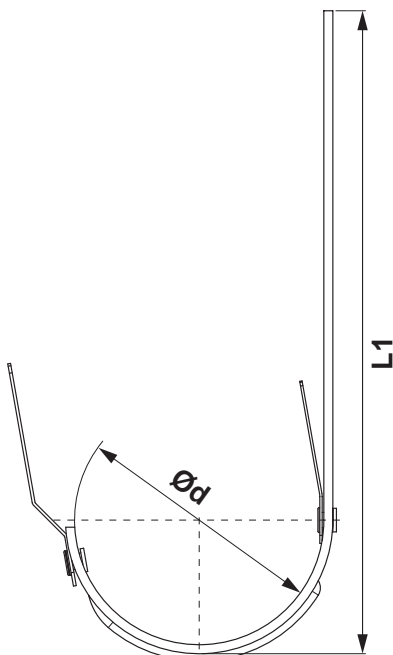

Dimensions (mm)	L1	Ød
250	310	105
280	345	127
333 – 550	385	153
333 – 610	445	153
400	400	192

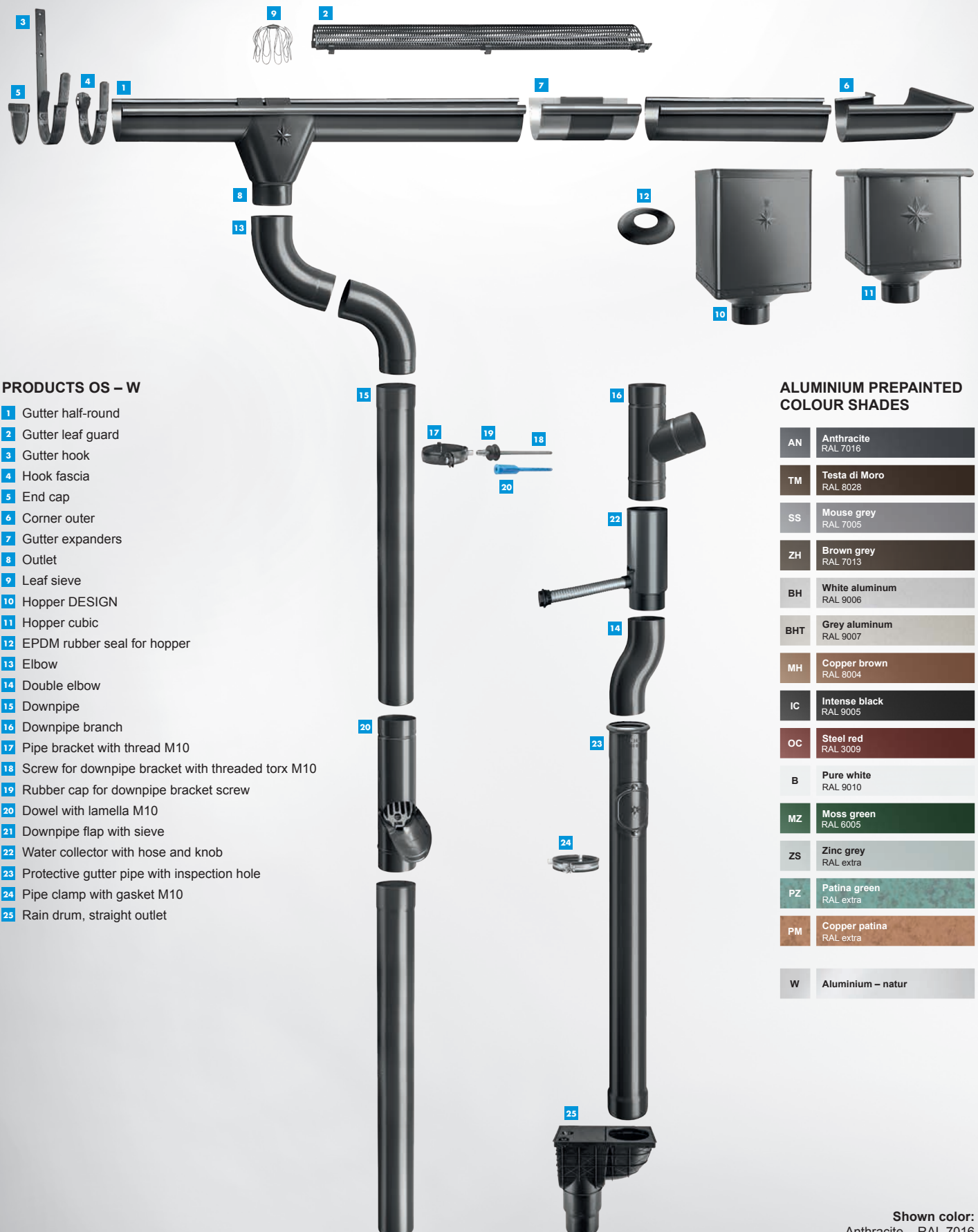

PRODUCTS OS – W

- 1 Gutter half-round
- 2 Gutter leaf guard
- 3 Gutter hook
- 4 Hook fascia
- 5 End cap
- 6 Corner outer
- 7 Gutter expanders
- 8 Outlet
- 9 Leaf sieve
- 10 Hopper DESIGN
- 11 Hopper cubic
- 12 EPDM rubber seal for hopper
- 13 Elbow
- 14 Double elbow
- 15 Downpipe
- 16 Downpipe branch
- 17 Pipe bracket with thread M10
- 18 Screw for downpipe bracket with threaded torx M10
- 19 Rubber cap for downpipe bracket screw
- 20 Dowel with lamella M10
- 21 Downpipe flap with sieve
- 22 Water collector with hose and knob
- 23 Protective gutter pipe with inspection hole
- 24 Pipe clamp with gasket M10
- 25 Rain drum, straight outlet

**ALUMINIUM PREPAINTED
COLOUR SHADES**

AN	Anthracite RAL 7016
TM	Testa di Moro RAL 8028
SS	Mouse grey RAL 7005
ZH	Brown grey RAL 7013
BH	White aluminum RAL 9006
BHT	Grey aluminum RAL 9007
MH	Copper brown RAL 8004
IC	Intense black RAL 9005
OC	Steel red RAL 3009
B	Pure white RAL 9010
MZ	Moss green RAL 6005
ZS	Zinc grey RAL extra
PZ	Patina green RAL extra
PM	Copper patina RAL extra
W	Aluminium – natur



ALUMINIUM POLYESTER + NATUR

NOVELIS

It is an American industrial aluminium company based in Atlanta, Georgia in the United States. It is a subsidiary of the Indian aluminium and copper manufacturing company Hindalco Industries. Novelis is a leading manufacturer of rolled aluminium and a global leader in beverage can recycling. The company provides services to customers in industries including beverage cans, automotive industry, consumer electronics, construction, foils and packaging.

ADITYA BIRLA



SPEIRA

Speira is a global aluminium rolling and recycling company. It consists of seven manufacturing facilities, as well as one research and development centre. They are located in Germany and Norway including our Joint Venture Alunorf, the largest aluminium rolling mill in the world, Grevenbroich, the largest rolled aluminium finishing mill in the world, as well as several international sales offices. Speira employs around 5,000 people mainly in Germany and Norway.

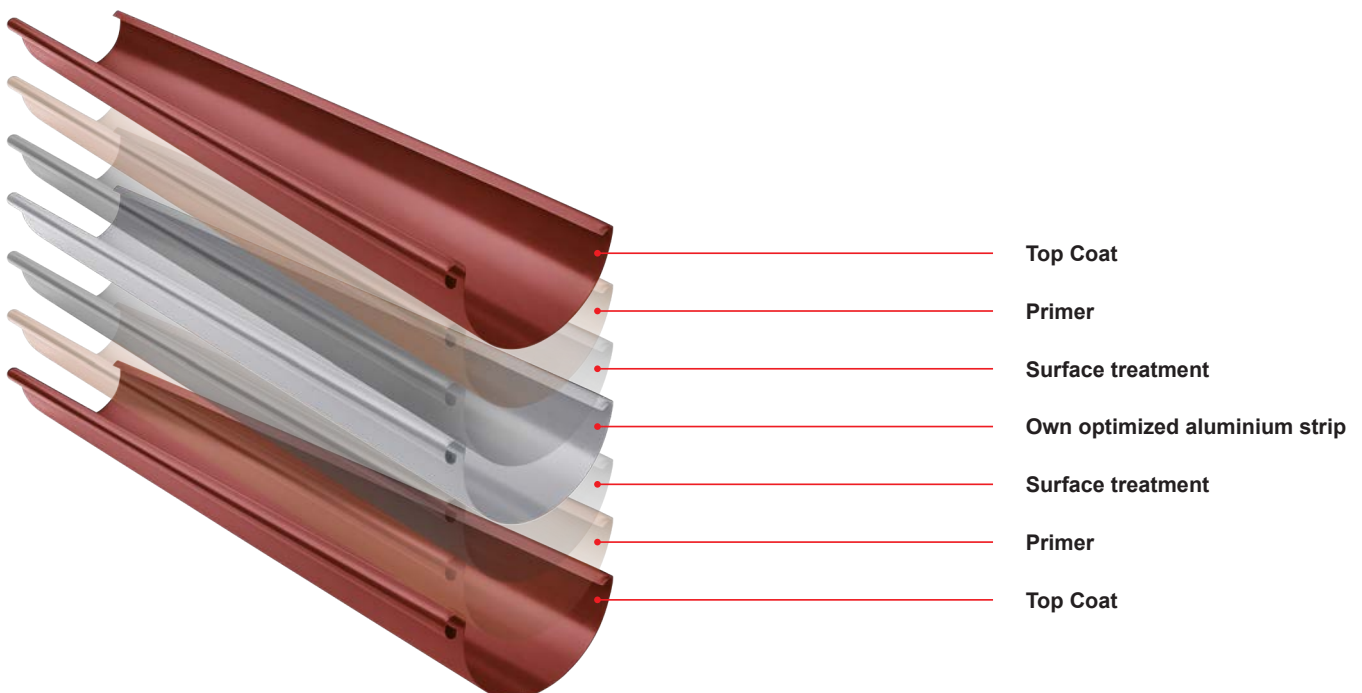

GUTTER HALF-ROUND [s=0,70]

W-WZ



Nominal dimension	200	250	250	280	280
Length in m	3,0	4,0	6,0	4,0	6,0
Price in €/m	With VAT	With VAT	With VAT	With VAT	With VAT
AN 1 Anthracite RAL 7016	8,12	6,64	6,64	8,49	8,49
	051066 *	051073	051080	051097	051103
TM 2 Testa di Moro RAL 8028	8,12	6,64	6,64	8,49	8,49
	051707 *	051714	051721	051738	051745
SS 3 Mouse grey RAL 7005		6,64	6,64	8,49	8,49
		051639	051646	051653	051660
ZH 4 Brown grey RAL 7013		6,64	6,64	8,49	8,49
		051790	051806	051813	051820
BH 5 White aluminum RAL 9006		6,64	6,64	8,49	8,49
		051233	051240 *	051257	051264
BHT 6 Grey aluminum RAL 9007		6,64	6,64	8,49	8,49
		101891 *	101907 *	101914 *	101921 *
MH 7 Copper brown RAL 8004		6,64	6,64	8,49	8,49
		051394	051400	051417	051424
IC 8 Intense black RAL 9005		6,64	6,64	8,49	8,49
		051318	051325 *	051332	051349 *
OC 9 Steel red RAL 3009		6,64	6,64	8,49	8,49
		051554	051561	051578	051585
B 10 Pure white RAL 9010		6,64	6,64	8,49	8,49
		051158	051165	051172	051189
MZ 11 Moss green RAL 6005		6,64	6,64	8,49	8,49
		051479	051486	051493	051509
ZS 12 Zinc grey RAL extra		6,64	6,64	8,49	8,49
		051875	051882 *	051899 *	051905 *
PZ 13 Patina green RAL extra					
PM 14 Copper patina RAL extra					
Aluminium 15 Natur		5,78	5,78	6,64	6,64
		049957	049964	049971	049988
Package in m 	15	20	30	20	30
Package in m 	1 200	960	1 440	840	1 260

* Custom production



GUTTER HALF-ROUND [s=0,70]

W-WZ



Nominal dimension	333	333	400
Length in m	4,0	6,0	6,0
Price in €/m	With VAT	With VAT	With VAT
AN 1 Anthracite RAL 7016	8,67	8,67	12,55
	051110	051127	051134
TM 2 Testa di Moro RAL 8028	8,67	8,67	12,55
	051752	051769	051776 *
SS 3 Mouse grey RAL 7005	8,67	8,67	12,55
	051677	051684	051691
ZH 4 Brown grey RAL 7013	8,67	8,67	12,55
	051837	051844	051851
BH 5 White aluminum RAL 9006	8,67	8,67	12,55
	051271	051288	051295
BHT 6 Grey aluminum RAL 9007	8,67	8,67	12,55
	101938	101945	070104 *
MH 7 Copper brown RAL 8004	8,67	8,67	12,55
	051431	051448	051455 *
IC 8 Intense black RAL 9005	8,67	8,67	12,55
	051356	051363	051370 *
OC 9 Steel red RAL 3009	8,67	8,67	12,55
	051592	051608	051615 *
B 10 Pure white RAL 9010	8,67	8,67	12,55
	051196	051202	051219 *
MZ 11 Moss green RAL 6005	8,67	8,67	12,55
	051516	051523	051530
ZS 12 Zinc grey RAL extra	8,67	8,67	12,55
	051912	051929	051936 *
PZ 13 Patina green RAL extra	11,07	11,07	
	112781 *	112798	
PM 14 Copper patina RAL extra	11,07	11,07	
	112767 *	112774	
Aluminium 15 Natur	7,44	7,44	9,96
	049995	050007	050014
Package in m 	20	30	30
Package in m 	660	990	810

* Custom production



GUTTER ON-ROOF [s=0,70]

W-WZS

Nominal dimension	650	700	700
Length in m	6,0	4,0	6,0
Price in €/m	With VAT	With VAT	With VAT
AN 1 Anthracite RAL 7016		28,29	28,29
		049193	049209
TM 2 Testa di Moro RAL 8028	22,94		
	049308 *		
SS 3 Mouse grey RAL 7005		28,29	28,29
		049285 *	049292
ZH 4 Brown grey RAL 7013		28,29	28,29
		049315	049322
BH 5 White aluminum RAL 9006	22,94		
	049223 *		
BHT 6 Grey aluminum RAL 9007	22,94		
	101990 *		
MH 7 Copper brown RAL 8004	22,94		
	049247 *		
IC 8 Intense black RAL 9005	22,94		
	049230 *		
OC 9 Steel red RAL 3009	22,94		
	049278 *		
B 10 Pure white RAL 9010	22,94		
	049216 *		
MZ 11 Moss green RAL 6005		28,29	28,29
		049254	049261
ZS 12 Zinc grey RAL extra	22,94		
	049339 *		
PZ 13 Patina green RAL extra			
PM 14 Copper patina RAL extra			
Aluminium 15 Natur	19,07		
	049186 *		
Package in m 	6	4	6
Package in m 	300	200	300



* Custom production

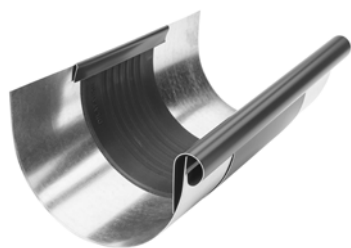

GUTTER EXPANDERS

W-WZDI





Nominal dimension	250/260	285/260	333/260	400/260
Price in €/pcs	With VAT	With VAT	With VAT	With VAT
AN 1 Anthracite RAL 7016	25,22	26,45	26,45	33,21
	028341 *	028358 *	028365	028372
TM 2 Testa di Moro RAL 8028	25,22	26,45	26,45	33,21
	028662 *	028679 *	028686	028693 *
SS 3 Mouse grey RAL 7005	25,22	26,45	26,45	33,21
	028624 *	028631 *	028648 *	028655 *
ZH 4 Brown grey RAL 7013	25,22	26,45	26,45	33,21
	028709 *	028716 *	028723 *	028730 *
BH 5 White aluminum RAL 9006	25,22	26,45	26,45	33,21
	028426 *	028433 *	028440	028457
BHT 6 Grey aluminum RAL 9007	25,22	26,45	26,45	33,21
	101440 *	101457 *	101464 *	070135 *
MH 7 Copper brown RAL 8004	25,22	26,45	26,45	33,21
	028501 *	028518 *	028525 *	028532 *
IC 8 Intense black RAL 9005	25,22	26,45	26,45	33,21
	028464 *	028471 *	028488 *	028495 *
OC 9 Steel red RAL 3009	25,22	26,45	26,45	33,21
	028587 *	028594 *	028600 *	028617 *
B 10 Pure white RAL 9010	25,22	26,45	26,45	33,21
	028389 *	028396 *	028402 *	028419 *
MZ 11 Moss green RAL 6005	25,22	26,45	26,45	33,21
	028549 *	028556 *	028563 *	028570 *
ZS 12 Zinc grey RAL extra	25,22	26,45	26,45	33,21
	028747 *	028754 *	028761 *	028778 *
PZ 13 Patina green RAL extra			39,98	
			112590 *	
PM 14 Copper patina RAL extra			39,98	
			112583 *	
Aluminium 15 Natur	27,92	29,03	31,37	38,99
	028303 *	028310 *	028327 *	028334 *
Package in pcs 	3	3	5	5
Package in pcs 	360	360	200	200

* Custom production

ON-ROOF GUTTER EXPANSION COMPONENT

W-WZSDI

Nominal dimension	670/260	
Price in €/pcs	With VAT	
AN 1 Anthracite RAL 7016	79,95	029157 *
TM 2 Testa di Moro RAL 8028	79,95	029232 *
SS 3 Mouse grey RAL 7005	79,95	029225 *
ZH 4 Brown grey RAL 7013	79,95	029249 *
BH 5 White aluminum RAL 9006	79,95	029171 *
BHT 6 Grey aluminum RAL 9007	79,95	101471 *
MH 7 Copper brown RAL 8004	79,95	029195 *
IC 8 Intense black RAL 9005	79,95	029188 *
OC 9 Steel red RAL 3009	79,95	029218 *
B 10 Pure white RAL 9010	79,95	029164 *
MZ 11 Moss green RAL 6005	79,95	029201 *
ZS 12 Zinc grey RAL extra	79,95	029256 *
PZ 13 Patina green RAL extra		
PM 14 Copper patina RAL extra		
Aluminium 15 Natur	71,96	029140 *
Package in pcs 	1	
Package in pcs 	40	

* Custom production



ALUMINIUM
POLYESTER + NATUR



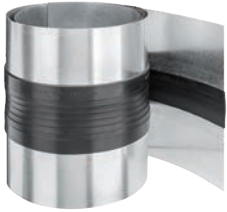

ALUMINIUM

POLYESTER + NATUR



ENDLESS TAPES

W-WZDIP

Nominal dimension	Lenght in m	EAN product number	Packaging in m		Price with VAT [€/m]
					
260	3,0	028181	3	120	49,20

ALUMINIUM
POLYESTER + NATUR

USE OF DILATATION GUTTER AND DILATATION STRIP

DILATATION GUTTER

Installation example: hanging gutter with a developed width of up to 500 mm. The dilatation gutter shall be installed at spacing of 15 m. For outer corner and beginning of the gutter, a half of the standard value is applied: maximum 7,5 m. For inner corner, a quarter of the standard value is applied: maximum 3,75 m. For other materials and dimensions: see the table below. Corners are always taken into account as fixed points.

ROOF SEMICIRCULAR DILATATION GUTTERS

Developed gutter width	Aluminium	Steel, Titanium-zinc, Copper, Stainless steel
< 500	12	15
> 500	8	10

DILATATION STRIP

Indoor installation: on gutters attached without gluing to a substrate, roofs with non-standard profile and roof cladding

ROOF DILATATION STRIP

Developed gutter width	Aluminium	Steel, Titanium-zinc, Copper, Stainless steel
< 500	8	10
> 500	6	8

For outer corner or the beginning of the gutter, a half of the standard value shall be applied.

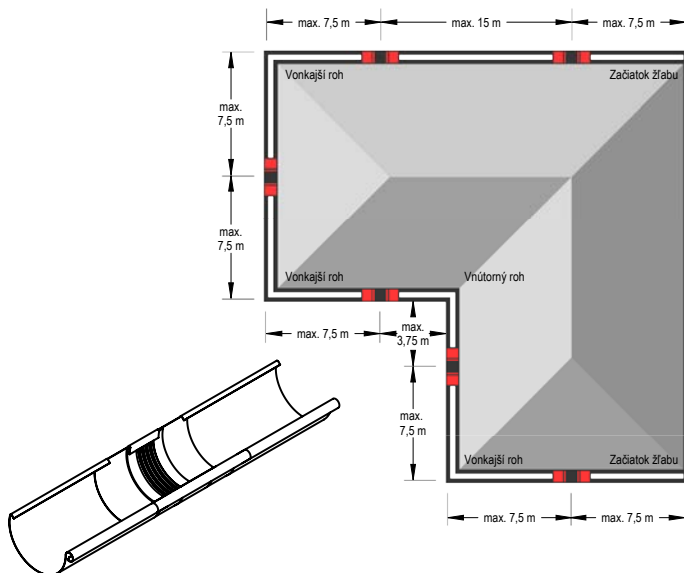

Note to the dilatation gutter mounting.

When mounting by soldering, first cover the middle rubber part with a wet cloth (to prevent heat transfer to the middle rubber part). A minimum distance of 6 cm from the middle rubber part must be kept. In any case avoid contact of rubber with open flame.

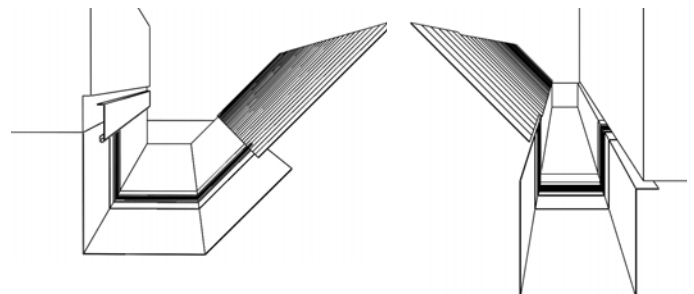



Note to the dilatation strip mounting.

When bending and mounting dilatation elements, make sure that:

- Bending jaws have a radius of at least 2 mm.
- For sheet metal thicknesses over 1 mm, it must be observed bending radius at least 5 mm.
- When bending, the bending jaws should be set to a thickness of the middle rubber part of 3 to 4 mm to prevent the cutting effect - damage to the rubber.
- The rubber middle part must not be compressed or damaged during bending. Therefore, an aluminium sheet strip 2 to 5 mm (thick) should be used, bent so that it can be attached as a protection to the bending jaws. This achieves a larger bending radius and prevents the rubber middle part from breaking.

GUTTER LEAF GUARD

W-WZNLM

Nominal dimension		333
Length in m		2,0
Price in €/pcs		With VAT
AN 1 Anthracite RAL 7016		32,60 064950
TM 2 Testa di Moro RAL 8028		32,60 064981 *
SS 3 Mouse grey RAL 7005		32,60 064974
ZH 4 Brown grey RAL 7013		32,60 118127 *
BH 5 White aluminum RAL 9006		32,60 118080 *
BHT 6 Grey aluminum RAL 9007		32,60 118097 *
MH 7 Copper brown RAL 8004		32,60 118103 *
IC 8 Intense black RAL 9005		32,60 118059
OC 9 Steel red RAL 3009		32,60 118066 *
B 10 Pure white RAL 9010		32,60 118134 *
MZ 11 Moss green RAL 6005		32,60 118110 *
ZS 12 Zinc grey RAL extra		32,60 118073 *
PZ 13 Patina green RAL extra		
PM 14 Copper patina RAL extra		
Aluminium 15 Natur		31,37 064905
Package in pcs 		15
Package in pcs 		120

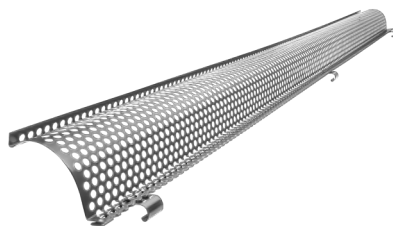

* Custom production



ALUMINIUM POLYESTER + NATUR

PVC GUTTER GUARD

SD-ZNL MRIEZKA

Nominal dimension	Lenght in m	EAN product number	Packaging in pcs		Price with VAT [€/pcs]
PS 171	1,0	008473	30	450	5,54
TM 171	1,0	008466	30	450	5,54

PVC GUTTER GUARD

SD-ZNL N

Nominal dimension	Lenght in m	EAN product number	Packaging in pcs		Price with VAT [€/pcs]
250	3,0	008480	10	400	29,40
280-333	3,0	008497	10	400	29,52

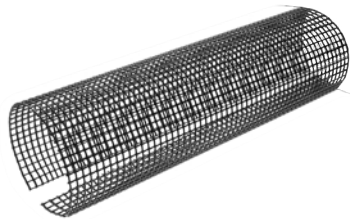
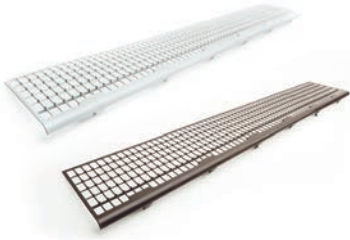

GUTTER HOOK

W-WHP

Nominal dimension	250/430	280/480	333/550	333/650	400/650
Material	23/7	28/7	28/7	28/7	30/7
Price in €/pcs	With VAT	With VAT	With VAT	With VAT	With VAT
AN 1 Anthracite RAL 7016	4,18	4,80	5,29	6,03	6,40
	077615	077622	077639	077646	077653
TM 2 Testa di Moro RAL 8028	4,18	4,80	5,29	6,03	6,40
	078018	078025	078032	078049	078056
SS 3 Mouse grey RAL 7005	4,18	4,80	5,29	6,03	6,40
	077967	077974	077981	077998	078001
ZH 4 Brown grey RAL 7013	4,18	4,80	5,29	6,03	6,40
	078063	078070	078117	078087	078094
BH 5 White aluminum RAL 9006	4,18	4,80	5,29	6,03	6,40
	077714	077738	077721	077745 *	077752
BHT 6 Grey aluminum RAL 9007	4,18	4,80	5,29	6,03	6,40
	101488 *	101495 *	101501	101518 *	080264 *
MH 7 Copper brown RAL 8004	4,18	4,80	5,29	6,03	6,40
	077813	077820	077837	077844 *	077851
IC 8 Intense black RAL 9005	4,18	4,80	5,29	6,03	6,40
	077769	077776	077783	077790 *	077806
OC 9 Steel red RAL 3009	4,18	4,80	5,29	6,03	6,40
	077912	077929	077936	077943 *	077950
B 10 Pure white RAL 9010	4,18	4,80	5,29	6,03	6,40
	077660	077677	077684	077691 *	077707
MZ 11 Moss green RAL 6005	4,18	4,80	5,29	6,03	6,40
	077868	077899	077875	077882	077905
ZS 12 Zinc grey RAL extra	4,18	4,80	5,29	6,03	6,40
	078124	078100	078131	078148 *	078155 *
PZ 13 Patina green RAL extra			11,07		
			112613		
PM 14 Copper patina RAL extra			11,07		
			112606		
Aluminium 15 Natur	3,75	4,31	4,74	5,41	5,78
	011930	011947	077585	077592	077608
Package in pcs 	25	25	25	15	20
Package in pcs 	1 000	1 000	1 000	600	800

* Custom production



HOOK FASCIA

W-WHPK



Nominal dimension	250	280	333
Material	28/7	28/7	28/7
Price in €/pcs	With VAT	With VAT	With VAT
AN 1 Anthracite RAL 7016	4,74	4,80	4,86
	011596	011602	011619
TM 2 Testa di Moro RAL 8028	4,74	4,80	4,86
	011831	011848	011855
SS 3 Mouse grey RAL 7005	4,74	4,80	4,86
	011800	011817 *	011824
ZH 4 Brown grey RAL 7013	4,74	4,80	4,86
	011862	011879	011886
BH 5 White aluminum RAL 9006	4,74	4,80	4,86
	011657	011664	011671
BHT 6 Grey aluminum RAL 9007	4,74	4,80	4,86
	101402 *	101396 *	101389 *
MH 7 Copper brown RAL 8004	4,74	4,80	4,86
	011718	011725 *	011732
IC 8 Intense black RAL 9005	4,74	4,80	4,86
	011688	011695 *	011701
OC 9 Steel red RAL 3009	4,74	4,80	4,86
	011770 *	011787 *	011794
B 10 Pure white RAL 9010	4,74	4,80	4,86
	011626	011633	011640
MZ 11 Moss green RAL 6005	4,74	4,80	4,86
	011749	011756	011763
ZS 12 Zinc grey RAL extra	4,74	4,80	4,86
	011893 *	011909 *	011916 *
PZ 13 Patina green RAL extra			
PM 14 Copper patina RAL extra			
Aluminium 15 Natur	4,24	4,31	4,37
	011565	011572	011589
Package in pcs 	25	25	25
Package in pcs 	1 000	1 000	1 000

* Custom production



ON-ROOF GUTTER HOOK WITH SUPPORT

W-WHSG



Nominal dimension	4
Material	28/7
Price in €/pcs	With VAT
AN 1 Anthracite RAL 7016	11,01 034113
TM 2 Testa di Moro RAL 8028	11,01 034199 *
SS 3 Mouse grey RAL 7005	11,01 034182
ZH 4 Brown grey RAL 7013	11,01 034205
BH 5 White aluminum RAL 9006	11,01 034137
BHT 6 Grey aluminum RAL 9007	11,01 101525 *
MH 7 Copper brown RAL 8004	11,01 034151
IC 8 Intense black RAL 9005	11,01 034144 *
OC 9 Steel red RAL 3009	11,01 034175 *
B 10 Pure white RAL 9010	11,01 034120 *
MZ 11 Moss green RAL 6005	11,01 034168
ZS 12 Zinc grey RAL extra	11,01 034212 *
PZ 13 Patina green RAL extra	
PM 14 Copper patina RAL extra	
Aluminium 15 Natur	9,90 034229 *
Package in pcs 	15
Package in pcs 	600

* Custom production



CORNER OUTER

W-WRA



Nominal dimension	200	250	280	333	400
Price in €/pcs	With VAT	With VAT	With VAT	With VAT	With VAT
AN 1 Anthracite RAL 7016		18,20	19,07	19,93	35,67
		082220	082237	082244	082251
TM 2 Testa di Moro RAL 8028		18,20	19,07	19,93	35,67
		082541	082558	082565	082572 *
SS 3 Mouse grey RAL 7005		18,20	19,07	19,93	35,67
		082503	082510	082527	082534
ZH 4 Brown grey RAL 7013		18,20	19,07	19,93	35,67
		082589	082596	082602	082619 *
BH 5 White aluminum RAL 9006		18,20	19,07	19,93	35,67
		082305	082312 *	082329	082336 *
BHT 6 Grey aluminum RAL 9007		18,20	19,07	19,93	35,67
		101839 *	101846 *	101853	080295 *
MH 7 Copper brown RAL 8004		18,20	19,07	19,93	35,67
		082381	082398	082404	082411 *
IC 8 Intense black RAL 9005		18,20	19,07	19,93	35,67
		082343	082350	082367	082374 *
OC 9 Steel red RAL 3009		18,20	19,07	19,93	35,67
		082466	082473	082480	082497 *
B 10 Pure white RAL 9010		18,20	19,07	19,93	35,67
		082268	082275	082282	082299 *
MZ 11 Moss green RAL 6005		18,20	19,07	19,93	35,67
		082428	082435	082442	082459 *
ZS 12 Zinc grey RAL extra		18,20	19,07	19,93	35,67
		082626	082633	082640	082657 *
PZ 13 Patina green RAL extra				21,77	
				112736	
PM 14 Copper patina RAL extra				21,77	
				112729	
Aluminium 15 Natur	16,36	16,36	17,16	17,96	32,10
	000514 *	000521	000538	000545	000552 *
Package in pcs 	5	5	5	5	5
Package in pcs 	150	150	150	150	150

* Custom production



CORNER INNER

W-WRI

Nominal dimension	200	250	280	333	400
Price in €/pcs	With VAT	With VAT	With VAT	With VAT	With VAT
AN 1 Anthracite RAL 7016		18,20	19,07	19,93	35,67
		081780	081797	081803	081810
TM 2 Testa di Moro RAL 8028		18,20	19,07	19,93	35,67
		082107	082114	082121	082138
SS 3 Mouse grey RAL 7005		18,20	19,07	19,93	35,67
		082060	082077	082084	082091 *
ZH 4 Brown grey RAL 7013		18,20	19,07	19,93	35,67
		082145	082152	082169	082176 *
BH 5 White aluminum RAL 9006		18,20	19,07	19,93	35,67
		081865 *	081872 *	081889	081896 *
BHT 6 Grey aluminum RAL 9007		18,20	19,07	19,93	35,67
		101860 *	101877 *	101884	069221 *
MH 7 Copper brown RAL 8004		18,20	19,07	19,93	35,67
		081940	081957	081964	081971 *
IC 8 Intense black RAL 9005		18,20	19,07	19,93	35,67
		081902	081919	081926	081933 *
OC 9 Steel red RAL 3009		18,20	19,07	19,93	35,67
		082022	082039	082046	082053 *
B 10 Pure white RAL 9010		18,20	19,07	19,93	35,67
		081827	081834	081841	081858 *
MZ 11 Moss green RAL 6005		18,20	19,07	19,93	35,67
		081988	081995	082008	082015 *
ZS 12 Zinc grey RAL extra		18,20	19,07	19,93	35,67
		082183	082190	082206	082213 *
PZ 13 Patina green RAL extra				21,77	
				112750	
PM 14 Copper patina RAL extra				21,77	
				112743	
Aluminium 15 Natur	16,36	16,36	17,16	17,96	32,10
	000569 *	000576 *	000583 *	000590 *	000606 *
Package in pcs 	5	5	5	5	5
Package in pcs 	150	150	150	150	150

* Custom production



ALUMINIUM POLYESTER + NATUR

END CAP

W-WCL

Nominal dimension	200	250	280	333	400
Price in €/pcs	With VAT	With VAT	With VAT	With VAT	With VAT
AN 1 Anthracite RAL 7016	1,85	1,85	1,91	1,97	2,95
	085856 *	085863	085870	085887	085894
TM 2 Testa di Moro RAL 8028	1,85	1,85	1,91	1,97	2,95
	086228 *	086235	086242	086259	086266
SS 3 Mouse grey RAL 7005		1,85	1,91	1,97	2,95
		086181	086198	086204	086211
ZH 4 Brown grey RAL 7013		1,85	1,91	1,97	2,95
		086273	086280	086297	086303
BH 5 White aluminum RAL 9006		1,85	1,91	1,97	2,95
		085948	085955	085962	085979
BHT 6 Grey aluminum RAL 9007		1,85	1,91	1,97	2,95
		101419 *	101426 *	101433	080257 *
MH 7 Copper brown RAL 8004		1,85	1,91	1,97	2,95
		086020	086037	086044	086051
IC 8 Intense black RAL 9005		1,85	1,91	1,97	2,95
		085986	085993	086006	086013 *
OC 9 Steel red RAL 3009		1,85	1,91	1,97	2,95
		086105	086112	086129	086136
B 10 Pure white RAL 9010		1,85	1,91	1,97	2,95
		085900	085917	085924	085931 *
MZ 11 Moss green RAL 6005		1,85	1,91	1,97	2,95
		086068	086075	086082	086099 *
ZS 12 Zinc grey RAL extra		1,85	1,91	1,97	2,95
		086310	086327 *	086334	086341 *
PZ 13 Patina green RAL extra				4,92	
				086174	
PM 14 Copper patina RAL extra				4,92	
				086150	
Aluminium 15 Natur		1,66	1,72	1,78	2,64
		085818	085825	085832	085849
Package in pcs	6/60	6/60	6/60	6/60	4/40
Package in pcs	1 440	1 440	1 440	1 440	960



* Custom production



ALUMINIUM
POLYESTER + NATUR

OUTLET

W-WKL



Nominal dimension	200/60	250/60	250/80	280/80	280/100
Price in €/pcs	With VAT	With VAT	With VAT	With VAT	With VAT
AN 1 Anthracite RAL 7016	12,30	13,04	13,90	15,99	15,38
	078278	078285	078292	078308	078315
TM 2 Testa di Moro RAL 8028	12,30	13,04	13,90	15,99	15,38
	079152	079169	079176	079183	079190
SS 3 Mouse grey RAL 7005	12,30	13,04	13,90	15,99	15,38
	079046 *	079053 *	079060	079077	079084
ZH 4 Brown grey RAL 7013	12,30	13,04	13,90	15,99	15,38
	079268 *	079275	079282	079299	079305
BH 5 White aluminum RAL 9006	12,30	13,04	13,90	15,99	15,38
	078490 *	078506 *	078513	078520	078537
BHT 6 Grey aluminum RAL 9007			13,90	15,99	15,38
			101594	101600 *	101617 *
MH 7 Copper brown RAL 8004	12,30	13,04	13,90	15,99	15,38
	078711 *	078728 *	078735	078742	078759
IC 8 Intense black RAL 9005	12,30	13,04	13,90	15,99	15,38
	078605 *	078612 *	078629	078636	078643
OC 9 Steel red RAL 3009	12,30	13,04	13,90	15,99	15,38
	078964 *	078933 *	078940	078957	078971
B 10 Pure white RAL 9010	12,30	13,04	13,90	15,99	15,38
	078384 *	078391 *	078407	078414	078421
MZ 11 Moss green RAL 6005	12,30	13,04	13,90	15,99	15,38
	078827 *	078834 *	078841	078858	078865
ZS 12 Zinc grey RAL extra	12,30	13,04	13,90	15,99	15,38
	079374 *	079381 *	079398	079404	079411
PZ 13 Patina green RAL extra					
PM 14 Copper patina RAL extra					
Aluminium 15 Natur	11,07	11,75	12,55	14,39	13,84
	078162 *	078179 *	078186	078193	078223
Package in pcs 	20	20	20	20	20
Package in pcs 	600	600	600	600	600

* Custom production



OUTLET

W-WKL

Nominal dimension	333/80	333/100	333/120
Price in €/pcs	With VAT	With VAT	With VAT
AN 1 Anthracite RAL 7016	16,48 078322	16,85 078339	22,14 078346
TM 2 Testa di Moro RAL 8028	16,48 079206	16,85 079213	22,14 079220
SS 3 Mouse grey RAL 7005	16,48 079091 *	16,85 079107	22,14 079114
ZH 4 Brown grey RAL 7013	16,48 079312 *	16,85 079336	22,14 079329
BH 5 White aluminum RAL 9006	16,48 078544	16,85 078551	22,14 078568
BHT 6 Grey aluminum RAL 9007	16,48 101624 *	16,85 101631	22,14 101648 *
MH 7 Copper brown RAL 8004	16,48 078766 *	16,85 078773	22,14 078780
IC 8 Intense black RAL 9005	16,48 078650 *	16,85 078667	22,14 078674
OC 9 Steel red RAL 3009	16,48 078988 *	16,85 078995	22,14 079015
B 10 Pure white RAL 9010	16,48 078438	16,85 078445	22,14 078452
MZ 11 Moss green RAL 6005	16,48 078872 *	16,85 078889	22,14 078896
ZS 12 Zinc grey RAL extra	16,48 079428 *	16,85 079435	22,14 079442
PZ 13 Patina green RAL extra		23,62 112675	
PM 14 Copper patina RAL extra		23,62 112668	
Aluminium 15 Natur	14,82 078209	15,19 078230	19,93 078216
Package in pcs 	20	20	15
Package in pcs 	600	600	300



* Custom production

ALUMINIUM
POLYESTER + NATUR



OUTLET

W-WKL

Nominal dimension	400/100	400/120	400/150
Price in €/pcs	With VAT	With VAT	With VAT
AN 1 Anthracite RAL 7016	23,00 078353 *	24,60 078360	43,05 078377 *
TM 2 Testa di Moro RAL 8028	23,00 079237 *	24,60 079244	43,05 079251 *
SS 3 Mouse grey RAL 7005	23,00 079121 *	24,60 079138	43,05 079145 *
ZH 4 Brown grey RAL 7013	23,00 079343 *	24,60 079350	43,05 079367
BH 5 White aluminum RAL 9006	23,00 078575 *	24,60 078582	43,05 078599 *
BHT 6 Grey aluminum RAL 9007		24,60 080288 *	
MH 7 Copper brown RAL 8004	23,00 078797 *	24,60 078803	43,05 078810 *
IC 8 Intense black RAL 9005	23,00 078681 *	24,60 078698	43,05 078704 *
OC 9 Steel red RAL 3009	23,00 079008 *	24,60 079022 *	43,05 079039 *
B 10 Pure white RAL 9010	23,00 078469 *	24,60 078476	43,05 078483 *
MZ 11 Moss green RAL 6005	23,00 078902 *	24,60 078919	43,05 078926 *
ZS 12 Zinc grey RAL extra	23,00 079459 *	24,60 079466	43,05 079473 *
PZ 13 Patina green RAL extra			
PM 14 Copper patina RAL extra			
Aluminium 15 Natur	20,73 078247 *	22,14 078254	38,75 078261 *
Package in pcs 	15	15	15
Package in pcs 	300	300	300

* Custom production





ALUMINIUM POLYESTER + NATUR

NEW CLAMPING SYSTEM FEDER ENABLES TO TURN THE ELBOW EASY IN THE DESIRED DIRECTION AND HOLDS RELIABLY IN ANY POSITION. EASY INSTALLATION TO ANY ELBOW WITHOUT RIVETING.



1



2



3

ALUMINIUM
POLYESTER + NATUR





ALUMINIUM POLYESTER + NATUR

STAINLESS STEEL LEAF SIEVE

N-NZN





Nominal dimension	EAN product number	Packaging in pcs		Price with VAT [€/pcs]
60	001153	30	2 160	6,83
80	001160	20	1 440	6,89
100	001177	15	1 080	7,01
120	001184	10	720	7,63
150	001191	5	360	12,05



HOPPER DESIGN

W-WKLZ DE

Nominal dimension	80	100	120
Price in €/pcs	With VAT	With VAT	With VAT
AN 1 Anthracite RAL 7016	122,88 031044 *	122,88 031068	129,15 031082 *
TM 2 Testa di Moro RAL 8028	122,88 032249 *	122,88 032263	129,15 032287 *
SS 3 Mouse grey RAL 7005	122,88 032096 *	122,88 032119	129,15 032133 *
ZH 4 Brown grey RAL 7013	122,88 032393 *	122,88 032416	129,15 032430 *
BH 5 White aluminum RAL 9006	122,88 031341 *	122,88 031365	129,15 031389 *
BHT 6 Grey aluminum RAL 9007			
MH 7 Copper brown RAL 8004	122,88 031648 *	122,88 031662 *	129,15 031686 *
IC 8 Intense black RAL 9005	122,88 031495 *	122,88 031518	129,15 031532 *
OC 9 Steel red RAL 3009	122,88 031945 *	122,88 031969 *	129,15 031983 *
B 10 Pure white RAL 9010	122,88 031198 *	122,88 031211	129,15 031235 *
MZ 11 Moss green RAL 6005	122,88 031792 *	122,88 031815 *	129,15 031839 *
ZS 12 Zinc grey RAL extra	122,88 032546 *	122,88 032560 *	129,15 032584 *
PZ 13 Patina green RAL extra			
PM 14 Copper patina RAL extra			
Aluminium 15 Natur	110,58 030894 *	110,58 030917 *	116,24 030931 *
Package in pcs 	2	2	2
Package in pcs 	36	36	36



* Custom production



HOPPER DESIGN ECCENTRIC

W-WKLZ DX





Nominal dimension	80	100	120
Price in €/pcs	With VAT	With VAT	With VAT
AN 1 Anthracite RAL 7016	141,45 031105 *	141,45 031136	153,75 031167
TM 2 Testa di Moro RAL 8028	141,45 032300 *	141,45 032331 *	153,75 032362 *
SS 3 Mouse grey RAL 7005	141,45 032157	141,45 032188	153,75 032218 *
ZH 4 Brown grey RAL 7013	141,45 032454 *	141,45 032485 *	153,75 032515 *
BH 5 White aluminum RAL 9006	141,45 031402 *	141,45 031433 *	153,75 031464 *
BHT 6 Grey aluminum RAL 9007	141,45 101655 *	141,45 101679 *	153,75 101693 *
MH 7 Copper brown RAL 8004	141,45 031709 *	141,45 031730 *	153,75 031761 *
IC 8 Intense black RAL 9005	141,45 031556 *	141,45 031587 *	153,75 031617 *
OC 9 Steel red RAL 3009	141,45 032003 *	141,45 032034 *	153,75 032065 *
B 10 Pure white RAL 9010	141,45 031259 *	141,45 031280 *	153,75 031310 *
MZ 11 Moss green RAL 6005	141,45 031853 *	141,45 031884 *	153,75 031914 *
ZS 12 Zinc grey RAL extra	141,45 032607 *	141,45 032638 *	153,75 032669 *
PZ 13 Patina green RAL extra			
PM 14 Copper patina RAL extra			
Aluminium 15 Natur	127,31 030955 *	135,30 030986 *	138,38 031013 *
Package in pcs 	2	2	2
Package in pcs 	36	36	36

* Custom production

HOPPER CUBIC

W-WKLZ KU



Nominal dimension	80	100	120
Price in €/pcs	With VAT	With VAT	With VAT
AN 1 Anthracite RAL 7016	157,44 031051 *	157,44 031075	178,35 031099 *
TM 2 Testa di Moro RAL 8028	157,44 032256 *	157,44 032270 *	178,35 032294 *
SS 3 Mouse grey RAL 7005	157,44 032102 *	157,44 032126 *	178,35 032140 *
ZH 4 Brown grey RAL 7013	157,44 032409 *	157,44 032423 *	178,35 032447 *
BH 5 White aluminum RAL 9006	157,44 031358 *	157,44 031372 *	178,35 031396 *
BHT 6 Grey aluminum RAL 9007			
MH 7 Copper brown RAL 8004	157,44 031655 *	157,44 031679 *	178,35 031693 *
IC 8 Intense black RAL 9005	157,44 031501 *	157,44 031525 *	178,35 031549 *
OC 9 Steel red RAL 3009	157,44 031952 *	157,44 031976 *	178,35 031990 *
B 10 Pure white RAL 9010	157,44 031204 *	157,44 031228 *	178,35 031242 *
MZ 11 Moss green RAL 6005	157,44 031808 *	157,44 031822 *	178,35 031846 *
ZS 12 Zinc grey RAL extra	157,44 032553 *	157,44 032577 *	178,35 032591 *
PZ 13 Patina green RAL extra			
PM 14 Copper patina RAL extra			
Aluminium 15 Natur	141,70 030900 *	141,70 030924 *	160,52 030948 *
Package in pcs 	2	2	2
Package in pcs 	36	36	36

* Custom production



HOPPER CUBIC ECCENTRIC

W-WKLZ KX

Nominal dimension	80	100	120
Price in €/pcs	With VAT	With VAT	With VAT
AN 1 Anthracite RAL 7016	166,05 031112 *	166,05 031143	178,35 031174 *
TM 2 Testa di Moro RAL 8028	166,05 032317 *	166,05 032348 *	178,35 032379 *
SS 3 Mouse grey RAL 7005	166,05 032164 *	166,05 032195 *	178,35 032225 *
ZH 4 Brown grey RAL 7013	166,05 032461 *	166,05 032492 *	178,35 032522 *
BH 5 White aluminum RAL 9006	166,05 031419 *	166,05 031440 *	178,35 031471 *
BHT 6 Grey aluminum RAL 9007	166,05 101662 *	166,05 101686 *	178,35 101709 *
MH 7 Copper brown RAL 8004	166,05 031716 *	166,05 031747 *	178,35 031778 *
IC 8 Intense black RAL 9005	166,05 031563 *	166,05 031594 *	178,35 031624 *
OC 9 Steel red RAL 3009	166,05 032010 *	166,05 032041 *	178,35 032072 *
B 10 Pure white RAL 9010	166,05 031266 *	166,05 031297 *	178,35 031327 *
MZ 11 Moss green RAL 6005	166,05 031860 *	166,05 031891 *	178,35 031921 *
ZS 12 Zinc grey RAL extra	166,05 032614 *	166,05 032645 *	178,35 032676 *
PZ 13 Patina green RAL extra			
PM 14 Copper patina RAL extra			
Aluminium 15 Natur	149,45 030962 *	149,45 030993 *	160,52 031020 *
Package in pcs 	2	2	2
Package in pcs 	36	36	36

* Custom production





ALUMINIUM

POLYESTER + NATUR

HOPPER CUBIC ECCENTRIC WITH OVERFLOW PIPE

W-WKLZ KXV

Nominal dimension	80	100	120
Price in €/pcs	With VAT	With VAT	With VAT
AN 1 Anthracite RAL 7016	196,80 031129 *	196,80 031150 *	209,10 031181 *
TM 2 Testa di Moro RAL 8028	196,80 032324 *	196,80 032355 *	209,10 032386 *
SS 3 Mouse grey RAL 7005	196,80 032171 *	196,80 032201 *	209,10 032232 *
ZH 4 Brown grey RAL 7013	196,80 032478 *	196,80 032508 *	209,10 032539 *
BH 5 White aluminum RAL 9006	196,80 031426 *	196,80 031457 *	209,10 031488 *
BHT 6 Grey aluminum RAL 9007			
MH 7 Copper brown RAL 8004	196,80 031723 *	196,80 031754 *	209,10 031785 *
IC 8 Intense black RAL 9005	196,80 031570 *	196,80 031600 *	209,10 031631 *
OC 9 Steel red RAL 3009	196,80 032027 *	196,80 032058 *	209,10 032089 *
B 10 Pure white RAL 9010	196,80 031273 *	196,80 031303 *	209,10 031334 *
MZ 11 Moss green RAL 6005	196,80 031877 *	196,80 031907 *	209,10 031938 *
ZS 12 Zinc grey RAL extra	196,80 032621 *	196,80 032652 *	209,10 032683 *
PZ 13 Patina green RAL extra			
PM 14 Copper patina RAL extra			
Aluminium 15 Natur	177,12 030979 *	177,12 031006 *	188,19 031037 *
Package in pcs 	2	2	2
Package in pcs 	36	36	36

* Custom production



ALUMINIUM
POLYESTER + NATUR



RUBBER SEAL FOR HOPPER

P-PKLZ T



Nominal dimension	EAN product number	Packaging in pcs		Price with VAT [€/pcs]
				
IC 70-85	077103	5	600	4,92
IC 100-110	077110	5	600	5,04
IC 110-125	077097	5	600	5,17
PS 70-85	077134	5	600	5,54
PS 100-110	077141	5	600	6,03
PS 110-125	077127	5	600	6,15

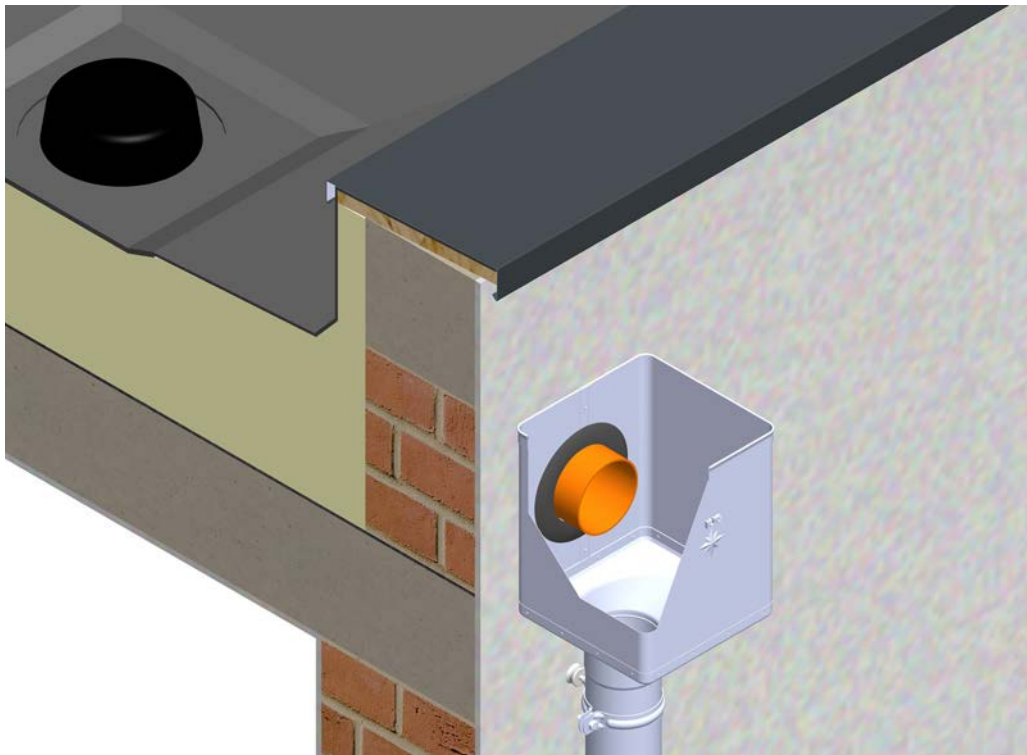

ALUMINIUM POLYESTER + NATUR

ELBOW 72°

W-WK



ALUMINIUM
POLYESTER + NATUR



Nominal dimension	60	80	100	120	150
Price in €/pcs	With VAT	With VAT	With VAT	With VAT	With VAT
AN 1 Anthracite RAL 7016	11,32	11,07	11,81	17,96	39,98
	074294	074300	074324	074348	074362
TM 2 Testa di Moro RAL 8028	11,32	11,07	11,81	17,96	39,98
	074935	074942	074966	074980	075000 *
SS 3 Mouse grey RAL 7005	11,32	11,07	11,81	17,96	39,98
	074850 *	074867	074881	074904	074928 *
ZH 4 Brown grey RAL 7013	11,32	11,07	11,81	17,96	39,98
	075017 *	075024	075048	075062	075086
BH 5 White aluminum RAL 9006	11,32	11,07	11,81	17,96	39,98
	074461	074454	074485	074508	074522 *
BHT 6 Grey aluminum RAL 9007		11,07	11,81	17,96	
		101587	101563	101549 *	
MH 7 Copper brown RAL 8004	11,32	11,07	11,81	17,96	39,98
	074614	074621	074645	074669	074683 *
IC 8 Intense black RAL 9005	11,32	11,07	11,81	17,96	39,98
	074539 *	074546	074560	074584	074607 *
OC 9 Steel red RAL 3009	11,32	11,07	11,81	17,96	39,98
	074775 *	074782	074805	074829	074843 *
B 10 Pure white RAL 9010	11,32	11,07	11,81	17,96	39,98
	074379	074386	074409	074423	074447 *
MZ 11 Moss green RAL 6005	11,32	11,07	11,81	17,96	39,98
	074690 *	074706	074720	074744	074768 *
ZS 12 Zinc grey RAL extra	11,32	11,07	11,81	17,96	39,98
	075093 *	075109	075123	075147	075161 *
PZ 13 Patina green RAL extra			11,32		
			112644		
PM 14 Copper patina RAL extra			11,32		
			112620		
Aluminium 15 Natur	9,96	9,96	10,95	17,84	35,67
	074218	074225	074249	074263	074287 *
Package in pcs	25	25	25	15	5
Package in pcs	600	400	300	180	60

* Custom production

ELBOW RADIUS 85°

W-WKR



Nominal dimension	80	100	120
Price in €/pcs	With VAT	With VAT	With VAT
AN 1 Anthracite RAL 7016	13,78 074317	17,22 074331	22,14 074355 *
TM 2 Testa di Moro RAL 8028	13,78 074959	17,22 074973	22,14 074997 *
SS 3 Mouse grey RAL 7005	13,78 074874 *	17,22 074898	22,14 074911 *
ZH 4 Brown grey RAL 7013	13,78 075031 *	17,22 075055	22,14 075079 *
BH 5 White aluminum RAL 9006	13,78 074478 *	17,22 074492	22,14 074515 *
BHT 6 Grey aluminum RAL 9007	13,78 101570 *	17,22 101556 *	22,14 101532 *
MH 7 Copper brown RAL 8004	13,78 074638 *	17,22 074652	22,14 074676 *
IC 8 Intense black RAL 9005	13,78 074553 *	17,22 074577 *	22,14 074591 *
OC 9 Steel red RAL 3009	13,78 074799 *	17,22 074812 *	22,14 074836 *
B 10 Pure white RAL 9010	13,78 074393	17,22 074416	22,14 074430 *
MZ 11 Moss green RAL 6005	13,78 074713 *	17,22 074737 *	22,14 074751 *
ZS 12 Zinc grey RAL extra	13,78 075116 *	17,22 075130 *	22,14 075154 *
PZ 13 Patina green RAL extra		12,05 112651	
PM 14 Copper patina RAL extra		12,05 112637	
Aluminium 15 Natur	12,42 074232 *	15,50 074256	19,93 074270 *
Package in pcs 	25	25	15
Package in pcs 	400	300	180

* Custom production

ALUMINIUM

POLYESTER + NATUR

ELBOW BLIND 40°

W-WKT



Nominal dimension	80	100	120
Price in €/pcs	With VAT	With VAT	With VAT
AN 1 Anthracite RAL 7016	10,95 081414	13,53 081421	18,33 081438
TM 2 Testa di Moro RAL 8028	10,95 081650	13,53 081667	18,33 081674 *
SS 3 Mouse grey RAL 7005	10,95 081629	13,53 081636	18,33 081643
ZH 4 Brown grey RAL 7013	10,95 081681	13,53 081698	18,33 081704
BH 5 White aluminum RAL 9006	10,95 081476	13,53 081483	18,33 081490 *
BHT 6 Grey aluminum RAL 9007	10,95 101778 *	13,53 101785 *	18,33 101792 *
MH 7 Copper brown RAL 8004	10,95 081537	13,53 081544	18,33 081551 *
IC 8 Intense black RAL 9005	10,95 081506 *	13,53 081513 *	18,33 081520 *
OC 9 Steel red RAL 3009	10,95 081599 *	13,53 081605	18,33 081612 *
B 10 Pure white RAL 9010	10,95 081445	13,53 081452	18,33 081469
MZ 11 Moss green RAL 6005	10,95 081568	13,53 081575	18,33 081582
ZS 12 Zinc grey RAL extra	10,95 081711	13,53 081728	18,33 081735
PZ 13 Patina green RAL extra			
PM 14 Copper patina RAL extra			
Aluminium 15 Natur	9,84 081384	12,18 081391	17,16 081407
Package in pcs 	25	25	15
Package in pcs 	400	300	240

* Custom production



DOWNPIPE [s=0,70]

W-WZR



Nominal dimension	60	80	80	80
Length in m	2,0	3,0	4,0	6,0
Price in €/m	With VAT	With VAT	With VAT	With VAT
AN 1 Anthracite RAL 7016	10,09	8,49	8,49	8,49
	050106	050113	050120	050137 *
TM 2 Testa di Moro RAL 8028	10,09	8,49	8,49	8,49
	050762	050779	050786	050793 *
SS 3 Mouse grey RAL 7005	10,09	8,49	8,49	8,49
	050687	050694	050700	052032 *
ZH 4 Brown grey RAL 7013	10,09	8,49	8,49	8,49
	050861	050878	051059	050892 *
BH 5 White aluminum RAL 9006	10,09	8,49	8,49	8,49
	050281	050298	050304	098283 *
BHT 6 Grey aluminum RAL 9007		8,49		
		101952 *		
MH 7 Copper brown RAL 8004	10,09	8,49	8,49	
	050441 *	050458	050465	
IC 8 Intense black RAL 9005	10,09	8,49	8,49	
	050366 *	050373	050380	
OC 9 Steel red RAL 3009	10,09	8,49	8,49	
	050601	050618	050625 *	
B 10 Pure white RAL 9010	10,09	8,49	8,49	
	050205	050212	050229	
MZ 11 Moss green RAL 6005	10,09	8,49	8,49	
	050526	050533	050540	
ZS 12 Zinc grey RAL extra	10,09	8,49	8,49	
	050960 *	050977	050984 *	
PZ 13 Patina green RAL extra				
PM 14 Copper patina RAL extra				
Aluminium 15 Natur	7,75	6,95	6,95	6,95
	050021	050038	050045	052070 *
Package in m 	10	18	24	30
Package in m 	490	216	288	750

* Custom production



DOWNPIPE [s=0,70]

W-WZR



Nominal dimension	100	100	100
Length in m	3,0	4,0	6,0
Price in €/m	With VAT	With VAT	With VAT
AN 1 Anthracite RAL 7016	9,47	9,47	9,35
	050144	050151	050168 *
TM 2 Testa di Moro RAL 8028	9,47	9,47	9,35
	050809	050816	050823 *
SS 3 Mouse grey RAL 7005	9,47	9,47	9,35
	050717	050724	052049 *
ZH 4 Brown grey RAL 7013	9,47	9,47	9,35
	050908	050915	050922 *
BH 5 White aluminum RAL 9006	9,47	9,47	9,35
	050311	050328	052056 *
BHT 6 Grey aluminum RAL 9007	9,47	9,47	
	101969	101976	
MH 7 Copper brown RAL 8004	9,47	9,47	
	050472	050489	
IC 8 Intense black RAL 9005	9,47	9,47	
	050397	050403	
OC 9 Steel red RAL 3009	9,47	9,47	
	050632	050649	
B 10 Pure white RAL 9010	9,47	9,47	
	050236	050243	
MZ 11 Moss green RAL 6005	9,47	9,47	
	050557	050564	
ZS 12 Zinc grey RAL extra	9,47	9,47	
	050991	051004	
PZ 13 Patina green RAL extra	12,24	12,24	
	112828	112835 *	
PM 14 Copper patina RAL extra	12,24	12,24	
	112804	112811 *	
Aluminium 15 Natur	8,24	8,24	8,06
	050052	050069	052025 *
Package in m 	18	24	30
Package in m 	180	240	480

* Custom production



DOWNPIPE [s=0,70]

W-WZR

Nominal dimension	120	120	120	150
Length in m	3,0	4,0	6,0	3,0
Price in €/m	With VAT	With VAT	With VAT	With VAT
AN 1 Anthracite RAL 7016	12,73	12,73		19,74
	050175	050182		050199 *
TM 2 Testa di Moro RAL 8028	12,73	12,73	12,73	19,74
	050830	050847	052063 *	050854 *
SS 3 Mouse grey RAL 7005	12,73	12,73		19,74
	050731	050748		050755 *
ZH 4 Brown grey RAL 7013	12,73	12,73		19,74
	050939	050946		050953 *
BH 5 White aluminum RAL 9006	12,73	12,73		19,74
	050335	050342		050359 *
BHT 6 Grey aluminum RAL 9007	12,73			
	101983			
MH 7 Copper brown RAL 8004	12,73	12,73		19,74
	050496	050502		050519 *
IC 8 Intense black RAL 9005	12,73	12,73		19,74
	050410	050427		050434 *
OC 9 Steel red RAL 3009	12,73	12,73		19,74
	050656	050663		050670 *
B 10 Pure white RAL 9010	12,73	12,73		19,74
	050250	050267		050274 *
MZ 11 Moss green RAL 6005	12,73	12,73		19,74
	050571	050588		050595 *
ZS 12 Zinc grey RAL extra	12,73	12,73		19,74
	051011 *	051028		051035 *
PZ 13 Patina green RAL extra				
PM 14 Copper patina RAL extra				
Aluminium 15 Natur	10,21	10,21		15,99
	050076	050083		050090 *
Package in m 	18	24	30	3
Package in m 	144	192	—	84

* Custom production







ALUMINIUM POLYESTER + NATUR



PLASTIC DOWNPIPE SLEEVE

SD-ZR FOLIA KJG



Nominal dimension	Lenght in m	EAN product number	Packaging in m		Price with VAT [€/m]
					
60-150	100,0	139726	100	6 000	0,47

ALUMINIUM
POLYESTER + NATUR

DOUBLE ELBOW

W-WKO





Nominal dimension	80	100	120
Price in €/pcs	With VAT	With VAT	With VAT
AN 1 Anthracite RAL 7016	13,53 063328	16,61 008411	19,68 011985
TM 2 Testa di Moro RAL 8028	13,53 023353	16,61 023377	19,68 023421
SS 3 Mouse grey RAL 7005	13,53 023230	16,61 023285	19,68 023919
ZH 4 Brown grey RAL 7013	13,53 023476	16,61 023513	19,68 023537
BH 5 White aluminum RAL 9006	13,53 064837	16,61 057877	19,68 057884
BHT 6 Grey aluminum RAL 9007	13,53 101716	16,61 101723	19,68 101730 *
MH 7 Copper brown RAL 8004	13,53 000316	16,61 000330	19,68 048738
IC 8 Intense black RAL 9005	13,53 057891	16,61 057907	19,68 048226 *
OC 9 Steel red RAL 3009	13,53 000507	16,61 068712	19,68 023209
B 10 Pure white RAL 9010	13,53 012029	16,61 013804	19,68 013811
MZ 11 Moss green RAL 6005	13,53 011923	16,61 000453	19,68 000477
ZS 12 Zinc grey RAL extra	13,53 023582	16,61 023629	19,68 023650
PZ 13 Patina green RAL extra		20,79 112699	
PM 14 Copper patina RAL extra		20,79 112682	
Aluminium 15 Natur	12,18 077165	14,94 077172	17,71 077189
Package in pcs 	20	20	15
Package in pcs 	320	240	180

* Custom production

DOWNPIPE BRANCH 72°

W-WZO

Nominal dimension	80/80	100/80	100/100
Price in €/pcs	With VAT	With VAT	With VAT
AN 1 Anthracite RAL 7016	47,36 096630 *	48,59 096647 *	49,08 096654
TM 2 Testa di Moro RAL 8028	47,36 110473 *	48,59 110480 *	49,08 110497
SS 3 Mouse grey RAL 7005	47,36 110404 *	48,59 110411 *	49,08 110428 *
ZH 4 Brown grey RAL 7013	47,36 110541 *	48,59 110558 *	49,08 110565
BH 5 White aluminum RAL 9006	47,36 110053 *	48,59 110060 *	49,08 110077 *
BHT 6 Grey aluminum RAL 9007	47,36 096555 *	48,59 096623 *	49,08 109972 *
MH 7 Copper brown RAL 8004	47,36 110190 *	48,59 110206 *	49,08 110213 *
IC 8 Intense black RAL 9005	47,36 110121 *	48,59 110138 *	49,08 110145 *
OC 9 Steel red RAL 3009	47,36 110336 *	48,59 110343 *	49,08 110350 *
B 10 Pure white RAL 9010	47,36 109989 *	48,59 109996 *	49,08 110008 *
MZ 11 Moss green RAL 6005	47,36 110268 *	48,59 110275 *	49,08 110282
ZS 12 Zinc grey RAL extra	47,36 110619 *	48,59 110626 *	49,08 110633 *
PZ 13 Patina green RAL extra			
PM 14 Copper patina RAL extra			
Aluminium 15 Natur	42,56 096562 *	43,67 096579 *	44,16 096586 *
Package in pcs 	4	4	4
Package in pcs 	90	120	120



* Custom production



DOWNPIPE BRANCH 72°

W-WZO



Nominal dimension	120/80	120/100	120/120
Price in €/pcs	With VAT	With VAT	With VAT
AN 1 Anthracite RAL 7016	52,89 096661 *	53,63 096678 *	54,00 096685 *
TM 2 Testa di Moro RAL 8028	52,89 110503 *	53,63 110510 *	54,00 110527 *
SS 3 Mouse grey RAL 7005	52,89 110435 *	53,63 110442 *	54,00 110459 *
ZH 4 Brown grey RAL 7013	52,89 110572 *	53,63 110589 *	54,00 110596 *
BH 5 White aluminum RAL 9006	52,89 110084 *	53,63 110091 *	54,00 110107 *
BHT 6 Grey aluminum RAL 9007	52,89 110046 *	53,63 110114 *	54,00 110183 *
MH 7 Copper brown RAL 8004	52,89 110220 *	53,63 110237 *	54,00 110244 *
IC 8 Intense black RAL 9005	52,89 110152 *	53,63 110169 *	54,00 110176 *
OC 9 Steel red RAL 3009	52,89 110367 *	53,63 110374 *	54,00 110381 *
B 10 Pure white RAL 9010	52,89 110015 *	53,63 110022 *	54,00 110039 *
MZ 11 Moss green RAL 6005	52,89 110299 *	53,63 110305 *	54,00 110312 *
ZS 12 Zinc grey RAL extra	52,89 110640 *	53,63 110657 *	54,00 110664 *
PZ 13 Patina green RAL extra			
PM 14 Copper patina RAL extra			
Aluminium 15 Natur	47,60 096593 *	48,34 096609 *	48,59 096616 *
Package in pcs 	3	3	3
Package in pcs 	90	90	90

* Custom production

PIPE BRACKET WITH THREAD M10

W-WOB



Nominal dimension	60	80	100	120	150
Price in €/pcs	With VAT	With VAT	With VAT	With VAT	With VAT
AN 1 Anthracite RAL 7016	4,37	4,12	4,18	4,80	7,20
	054982	054999	055002	055019	055026
TM 2 Testa di Moro RAL 8028	4,37	4,12	4,18	4,80	7,20
	055439	055446	055453	055460	055477 *
SS 3 Mouse grey RAL 7005	4,37	4,12	4,18	4,80	7,20
	055330 *	055347	055354	055361	055378 *
ZH 4 Brown grey RAL 7013	4,37	4,12	4,18	4,80	7,20
	055514	055521	055538	055545	055552 *
BH 5 White aluminum RAL 9006	4,37	4,12	4,18	4,80	7,20
	055088	055095	055101	055118	055125 *
BHT 6 Grey aluminum RAL 9007		4,12	4,18	4,80	
		101808	101815	101822 *	
MH 7 Copper brown RAL 8004	4,37	4,12	4,18	4,80	7,20
	055187 *	055194	055200	055217	055224 *
IC 8 Intense black RAL 9005	4,37	4,12	4,18	4,80	7,20
	055132 *	055149	055156	055163	055170 *
OC 9 Steel red RAL 3009	4,37	4,12	4,18	4,80	7,20
	055286 *	055293	055309	055316	055323 *
B 10 Pure white RAL 9010	4,37	4,12	4,18	4,80	7,20
	055033	055040	055057	055064	055071 *
MZ 11 Moss green RAL 6005	4,37	4,12	4,18	4,80	7,20
	055231 *	055248	055255	055262	055279 *
ZS 12 Zinc grey RAL extra	4,37	4,12	4,18	4,80	7,20
	055569 *	055576	055583	055590	055606 *
PZ 13 Patina green RAL extra			10,21		
			112712		
PM 14 Copper patina RAL extra			10,21		
			112705		
Aluminium 15 Natur	3,44	3,20	3,32	3,69	5,72
	054906 *	054913	054920	054937	054944 *
Package in pcs 	25	25	25	25	20
Package in pcs 	3 000	3 000	3 000	3 000	2 400

* Custom production



STAINLESS STEEL SCREW FOR DOWNPIPE BRACKET M8x30 P-POB-NSK





Nominal dimension	EAN product number	Packaging in pcs		Price with VAT [€/pcs]
				
M8 x 30 *	139658	1	–	0,31

* Custom production

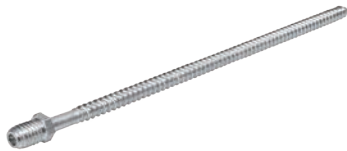

SCREW FOR DOWNPIPE BRACKET WITH THREADED TORX M10 P-POB-HT



Nominal dimension	EAN product number	Packaging in pcs		Price with VAT [€/pcs]
				
80	002464	100	40 000	1,23
140	002471	100	28 000	1,54
200	002488	100	20 000	1,91
250	002495	100	16 000	2,09
300	002501	100	11 200	2,09



DOWEL M10 P-POB-HN DB



Nominal dimension	EAN product number	Packaging in pcs		Price with VAT [€/pcs]
				
120	002426	100	25 000	0,49



DOWEL WITH LAMELLA M10 P-POB-HN DB



Nominal dimension	EAN product number	Packaging in pcs		Price with VAT [€/pcs]
				
180	002433	100	12 000	0,52
240	002440	100	12 000	0,62
280	002457	100	12 000	0,65

COMBISCREW TORX M10 P-POB-ZT/SZ





Nominal dimension	EAN product number	Packaging in pcs		Price with VAT [€/pcs]
				
140	002587	50	10 400	0,55
180	002594	50	10 400	0,68

INSULATION DOWEL M10

P-POB-HN IZOL





Nominal dimension	EAN product number	Packaging in pcs		Price with VAT [€/pcs]
				
M10 x 96	001207	25	2 625	3,32

INSULATING DOWEL TIP OF THE BRICK WITHOUT INSULATION

P-POB-HN WDVS140 M10





Nominal dimension	EAN product number	Packaging in pcs		Price with VAT [€/pcs]
				
140	144843	1/5	750	5,90

INSULATING DOWEL TIP OF THE BRICK WITH INSULATION

P-POB-HN WDVS300 M10





Nominal dimension	EAN product number	Packaging in pcs		Price with VAT [€/pcs]
				
300	144850	1/5	500	9,59

STAINLESS STEEL UNI PLATFORM TO ATTACH OB M10

P-POB-HN PLAT M10





Nominal dimension	EAN product number	Packaging in pcs		Price with VAT [€/pcs]
				
M10	144836	25/500	5 000	4,12

THREADED ROD M10

P-POB-ZT





Nominal dimension	EAN product number	Packaging in pcs		Price with VAT [€/pcs]
				
60	002556	100	20 800	0,25
100	002563	100	15 600	0,37
150	002570	50	10 400	0,68

DOWNPIPE BRACKET MOUNTING PLATE M10

P-POB-ZT MP





Nominal dimension	EAN product number	Packaging in pcs		Price with VAT [€/pcs]
				
80 x 30	002518	25	5 200	1,41

RUBBER CAP FOR DOWNPIPE BRACKET SCREW

P-POB-HT AKG





Nominal dimension	EAN product number	Packaging in pcs		Price with VAT [€/pcs]
				
TM 29 x 13	002280	50	16 800	0,31
AN 29 x 13	002211	50	16 800	0,31
IC 29 x 13	002235	50	16 800	0,31
OC 29 x 13	002266	50	16 800	0,31
MH 29 x 13	002242	50	16 800	0,31
B SB 29 x 13	002228	50	16 800	0,31
PS BH BHT 29 x 13	002273	50	16 800	0,31
MZ 29 x 13	002259	50	16 800	0,31
ZH 29 x 13	002297	50	16 800	0,31

DOWNPIPE FLAP



W-WZV



Nominal dimension	80	100	120
Price in €/pcs	With VAT	With VAT	With VAT
AN 1 Anthracite RAL 7016	25,83 035073	27,06 035080	36,90 035097
TM 2 Testa di Moro RAL 8028	25,83 035103	27,06 035110	36,90 035127
ZH 4 Brown grey RAL 7013	25,83 035134	27,06 035141	36,90 035158
Package in pcs 	6	5	3
Package in pcs 	180	150	90

DOWNPIPE FLAP WITH SIEVE

W-WZVS

Nominal dimension	80	100	120
Price in €/pcs	With VAT	With VAT	With VAT
AN 1 Anthracite RAL 7016	31,37 035226	34,44 035233	51,66 035240
TM 2 Testa di Moro RAL 8028	31,37 035462	34,44 035479	51,66 035486
SS 3 Mouse grey RAL 7005	31,37 035431	34,44 035448	51,66 035455
ZH 4 Brown grey RAL 7013	31,37 035493	34,44 035509	51,66 035516
BH 5 White aluminum RAL 9006	31,37 035288	34,44 035295	51,66 035301
BHT 6 Grey aluminum RAL 9007	31,37 102034 *	34,44 102041 *	51,66 102058 *
MH 7 Copper brown RAL 8004	31,37 035349	34,44 035356	51,66 035363
IC 8 Intense black RAL 9005	31,37 035318	34,44 035325	51,66 035332 *
OC 9 Steel red RAL 3009	31,37 035400	34,44 035417	51,66 035424
B 10 Pure white RAL 9010	31,37 035257	34,44 035264	51,66 035271
MZ 11 Moss green RAL 6005	31,37 035370	34,44 035387	51,66 035394
ZS 12 Zinc grey RAL extra	31,37 035523	34,44 035530	51,66 035547
PZ 13 Patina green RAL extra			
PM 14 Copper patina RAL extra			
Aluminium 15 Natur	25,09 035196 *	27,55 035202	41,33 035219 *
Package in pcs 	6	5	3
Package in pcs 	180	150	90

* Custom production



WATER COLLECTOR+HOSE

W-WZVHA



Nominal dimension	80	120
Price in €/pcs	With VAT	With VAT
AN 1 Anthracite RAL 7016	79,95 018854	153,75 018878 *
TM 2 Testa di Moro RAL 8028	79,95 019097	153,75 019110
SS 3 Mouse grey RAL 7005	79,95 019066 *	153,75 019080 *
ZH 4 Brown grey RAL 7013	79,95 019127 *	153,75 019141 *
BH 5 White aluminum RAL 9006	79,95 018915 *	153,75 018939 *
BHT 6 Grey aluminum RAL 9007	79,95 102003 *	153,75 102027 *
MH 7 Copper brown RAL 8004	79,95 018977 *	153,75 018991 *
IC 8 Intense black RAL 9005	79,95 018946 *	153,75 018960
OC 9 Steel red RAL 3009	79,95 019035 *	153,75 019059 *
B 10 Pure white RAL 9010	79,95 018885 *	153,75 018908 *
MZ 11 Moss green RAL 6005	79,95 019004	153,75 019028 *
ZS 12 Zinc grey RAL extra	79,95 019158 *	153,75 019172 *
PZ 13 Patina green RAL extra		
PM 14 Copper patina RAL extra		
Aluminium 15 Natur	71,96 001481	138,38 001504
Package in pcs 	1	1
Package in pcs 	60	60



* Custom production

ALUMINIUM

POLYESTER + NATUR

WATER COLLECTOR WITH HOSE AND KNOB

W-WZVHAG



Nominal dimension	100
Price in €/pcs	With VAT
AN 1 Anthracite RAL 7016	73,80 018861
TM 2 Testa di Moro RAL 8028	73,80 019103
SS 3 Mouse grey RAL 7005	73,80 019073
ZH 4 Brown grey RAL 7013	73,80 019134
BH 5 White aluminum RAL 9006	73,80 018922
BHT 6 Grey aluminum RAL 9007	73,80 102010 *
MH 7 Copper brown RAL 8004	73,80 018984 *
IC 8 Intense black RAL 9005	73,80 018953
OC 9 Steel red RAL 3009	73,80 019042 *
B 10 Pure white RAL 9010	73,80 018892
MZ 11 Moss green RAL 6005	73,80 019011
ZS 12 Zinc grey RAL extra	73,80 019165 *
PZ 13 Patina green RAL extra	
PM 14 Copper patina RAL extra	
Aluminium 15 Natur	66,42 001498
Package in pcs 	1
Package in pcs 	60

* Custom production



GALVANIZED STEEL PROTECTIVE GUTTER PIPE WITH INSPECTION HOLE W-WOZR





Nominal dimension	80	100	100
Length in m	1,0	1,0	1,5
Price in €/pcs	With VAT	With VAT	With VAT
AN 1 Anthracite RAL 7016	78,72 030344 *	60,27 030351 *	119,31 030368 *
TM 2 Testa di Moro RAL 8028	78,72 030641 *	60,27 030658 *	119,31 030665 *
SS 3 Mouse grey RAL 7005	78,72 030597 *	60,27 030603 *	119,31 030610 *
ZH 4 Brown grey RAL 7013	78,72 030696 *	60,27 030702 *	119,31 030719 *
BH 5 White aluminum RAL 9006	78,72 030795 *	60,27 030801 *	119,31 030818 *
BHT 6 Grey aluminum RAL 9007	78,72 102065 *	60,27 102072 *	119,31 102096 *
MH 7 Copper brown RAL 8004	78,72 030443 *	60,27 030450 *	119,31 030467 *
IC 8 Intense black RAL 9005	78,72 030849 *	60,27 030856 *	119,31 030863 *
OC 9 Steel red RAL 3009	78,72 030542 *	60,27 030559 *	119,31 030566 *
B 10 Pure white RAL 9010	78,72 030399 *	60,27 030405 *	119,31 030412 *
MZ 11 Moss green RAL 6005	78,72 030498 *	60,27 030504 *	119,31 030511 *
ZS 12 Zinc grey RAL extra	78,72 030740 *	60,27 030757 *	119,31 030764 *
PZ 13 Patina green RAL extra			
PM 14 Copper patina RAL extra			
Galvanized steel Natur	73,80 009708	55,35 009715	109,47 009722
Package in pcs 	1	1	1
Package in pcs 	70	60	60

* Custom production

ALUMINIUM

POLYESTER + NATUR

GALVANIZED STEEL PROTECTIVE GUTTER PIPE WITH INSPECTION HOLE W-WOZR

Nominal dimension	120	120
Length in m	1,0	1,5
Price in €/pcs	With VAT	With VAT
AN 1 Anthracite RAL 7016	141,45	202,95
	030375 *	030382 *
TM 2 Testa di Moro RAL 8028	141,45	202,95
	030672 *	030689 *
SS 3 Mouse grey RAL 7005	141,45	202,95
	030627 *	030634 *
ZH 4 Brown grey RAL 7013	141,45	202,95
	030726 *	030733 *
BH 5 White aluminum RAL 9006	141,45	202,95
	030825 *	030832 *
BHT 6 Grey aluminum RAL 9007	141,45	202,95
	102102 *	102089 *
MH 7 Copper brown RAL 8004	141,45	202,95
	030474 *	030481 *
IC 8 Intense black RAL 9005	141,45	202,95
	030870 *	030887 *
OC 9 Steel red RAL 3009	141,45	202,95
	030573 *	030580 *
B 10 Pure white RAL 9010	141,45	202,95
	030429 *	030436 *
MZ 11 Moss green RAL 6005	141,45	202,95
	030528 *	030535 *
ZS 12 Zinc grey RAL extra	141,45	202,95
	030771 *	030788 *
PZ 13 Patina green RAL extra		
PM 14 Copper patina RAL extra		
Galvanized steel Natur	129,15	175,89
	009739	009746
Package in pcs 	1	1
Package in pcs 	40	40



* Custom production



PIPE CLAMP WITH GASKET M10

P-POB-OZR



Nominal dimension	EAN product number	Packaging in pcs		Price with VAT [€/pcs]
				
80	002525	25	1 250	1,91
100	002532	25	1 250	2,46
120	002549	20	1 000	2,77

ALUMINIUM POLYESTER + NATUR

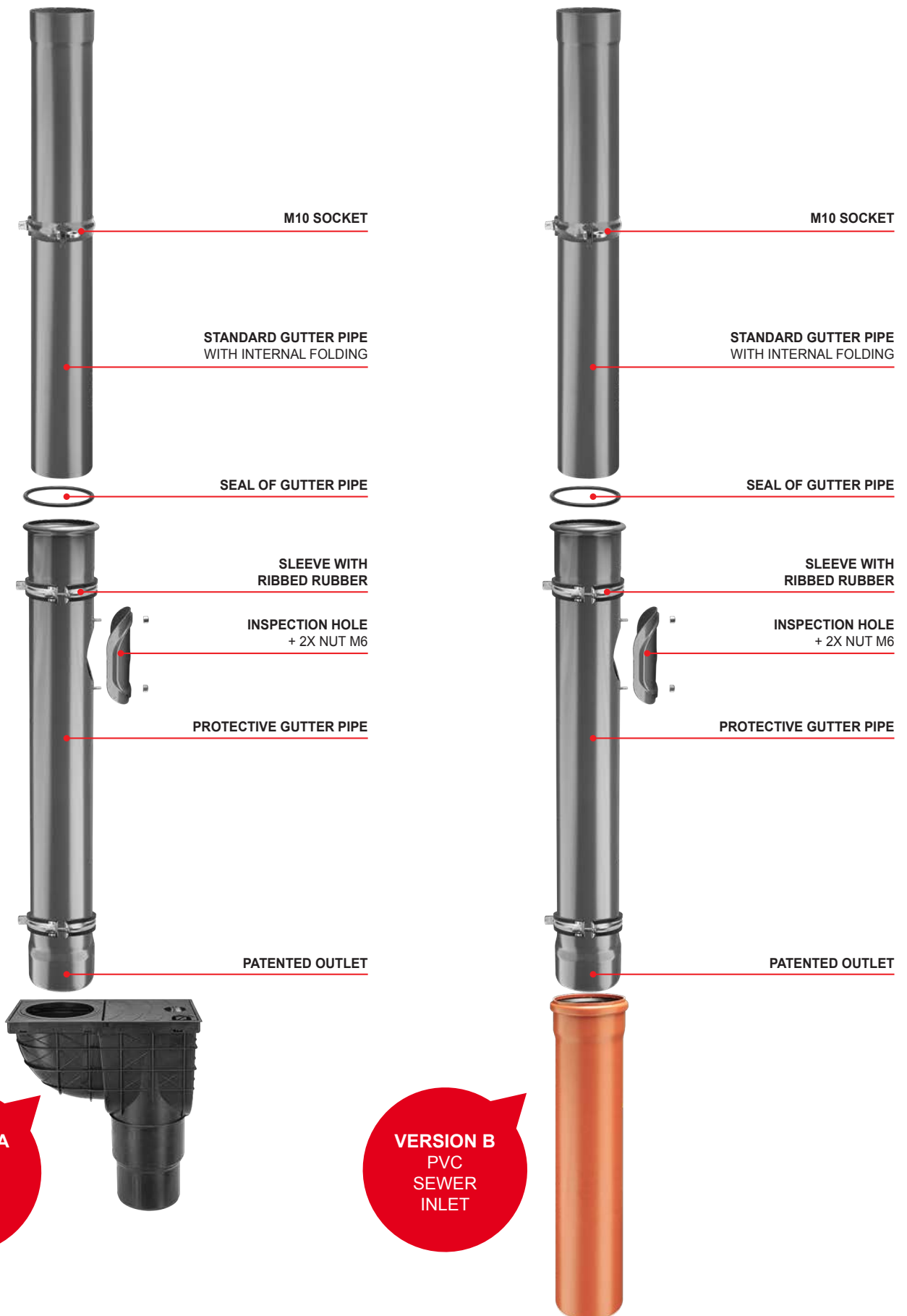

ALUMINIUM
POLYESTER + NATUR

I. BASIC PROVISIONS

- 1.1. The company KJG a.s., with its registered office at Malinovského 800/131, 916 21 Čachtice, Company ID: 31 439 951 (hereinafter referred to as the „Seller“), issues the following General business terms and conditions that apply to the sale and supply of gutter roof system with accessories, light roofing, trapezoids, metallurgical materials, roofing accessories, tools, machinery and commercial goods related to the roof system (hereinafter referred to as the „goods“) performed by the Seller on the basis of a framework purchase contract (referred to as „FPC“) in relation to an entrepreneur in carrying out its business activities and to the state, state organization, self-governing territorial unit or to a legal entity established by law as a public institution in the provision of public needs or its own operation (hereinafter referred to as the „Buyer“).
- 1.2. These General terms and conditions as an integrated part of FPC are an integral part of each individual purchase contract (hereinafter also „IPC“ or „contract“) concluded between the Seller and the Buyer on the basis of FPC.

II. CONCLUSION OF PURCHASE CONTRACT

- 2.1. The Buyer's written order is considered to be a proposal to conclude an IPC, whereby each Buyer's order should contain:
 - identification data of the Buyer necessary for issuing the invoice,
 - specification of the ordered goods (especially type, kind, quantity and dimensions),
 - delivery place, delivery time and method of delivery of goods,
 - date of issue of the order,
 - name, surname, position and signature of the person authorized to act on behalf of the Buyer.
- 2.3. The IPC is considered closed at the moment of written confirmation of the Buyer's order by the Seller.

III. PURCHASE PRICE AND PAYMENT TERMS

- 3.1. The Buyer undertakes to pay the Seller the purchase price for the ordered goods properly and in due time. The purchase price is determined according to the Seller's price list (prices of goods are to be understood without VAT) valid on the day of submitting the order by the Buyer and its amount will be stated by the Seller in the Buyer's order confirmation including VAT (when delivering goods in Slovakia) according to valid legal regulations. In necessary cases, if the purchase price is determined on the basis of individual price calculation based on the valid price list, the Buyer shall be obliged to pay the purchase price up to the amount determined by price calculation on condition that the Seller shall determine the final purchase price according to costs incurred, but this shall not exceed the purchase price determined by calculation. The buyer is entitled to a discount on the price of the goods in the amount resulting from the FPC; if the Seller changes the amount of the Buyer's discount on the price of the goods during the FPC period, it shall immediately inform the Buyer in writing. When delivering the goods in the Slovak Republic, the Seller charges the Buyer, in addition to the price of the goods, VAT in accordance with the valid legal regulations.
- 3.2. The Buyer shall have a set financial credit limit for the purchase of goods and the maturity of invoices in accordance with the FPC, while the Seller shall be entitled to invoice the purchase price to the Buyer on the day of delivery or shipping the goods to the Buyer, respectively. After overdrawing the credit limit specified in the FPC or in the case of non-payment of the invoice by the Buyer within the due date, the Seller is entitled to interrupt the delivery of goods to the Buyer on the basis of the contract and not to confirm another written order of the Buyer. The Seller shall continue with further deliveries of goods:
 - in the case of exceeded credit limit - after payment of the oldest invoices up to the amount of exceeding the credit limit and simultaneous payment of the value of the required purchase of goods,
 - in the case of non-payment of the invoice within the due date - after its full payment.
 The Seller shall be entitled to change the credit limit set for the Buyer at any time throughout the duration of the FPC.
- 3.3. Payment shall be deemed to have been made in time if it has been credited to the Seller's account or paid in cash at the Seller's cash desk by the due date.
- 3.4. If the Buyer does not pay the invoice within the due date, the Seller shall be entitled to charge the Buyer for interest on late payment in the amount of 0.05 % of the unpaid amount for each day of delay.

IV. DELIVERY OF GOODS AND RETENTION OF TITLE

- 4.1. The Seller shall be obliged to deliver the goods to the Buyer in the quantity agreed in the contract and in a quality and design that is suitable for the purpose for which the goods are used. The Buyer is obliged to take over the goods delivered by the Seller.
- 4.2. Unless the contracting parties have agreed otherwise, the Seller is obliged to pack or arrange the goods for transport in the manner that is usual for such goods in business.
- 4.3. Delivery of the goods shall take place within the period and in the manner agreed by the contracting parties in the contract.
- 4.4. Upon delivery of the goods by the Seller, the Buyer's employee shall be obliged to prove the right to take over the goods.
- 4.5. If the goods are to be made available not loaded on a means of transport at the Seller's registered office (or the relevant warehouse of the Seller, to which the Buyer has submitted an order) by the Buyer to the designated carrier, the latter is obliged to prove the right to take over the goods.
- 4.6. In the event that the goods are to be delivered to the Buyer to the delivery point specified in the order using a Seller's vehicle, the Seller will charge the Buyer for transport costs according to the transport price list valid on the day of submitting the order by the Buyer. At the same time, the Seller reserves the right to unload the goods only in an available terrain at its sole discretion.
- 4.7. In the case of goods to be sent to the Buyer, the Seller shall charge the Buyer for postage, unless agreed otherwise.
- 4.8. The buyer undertakes to withdraw the goods within the delivery period. If the Buyer fails to fulfil its obligation to take over the goods within the delivery period, the Seller shall invite the Buyer to fulfil the Seller's obligation within an additional reasonable period. Failure to take over the goods by the Buyer nor within an additional reasonable period gives rise to the Seller's right to withdraw from the contract.
- 4.9. The buyer who does not pay the whole amount of the purchase price until the delivery of the goods will acquire ownership of the delivered goods only after full payment of the purchase price.

V. PASSING OF RISK OF DAMAGE TO GOODS

- 5.1. The risk of damage to the goods passes to the Buyer at the moment the Buyer takes over the goods from the Seller, or by the carrier designated by him, or if the Buyer fails to do so in time, at the time when the Seller or the Seller's designated carrier allows the Buyer to dispose of the goods, while the Buyer is being aware of this possibility and breaches the contract by not taking over the goods.
- 5.2. If the Seller is to hand over the goods for transport by the carrier designated by the Buyer at its registered office in Čachtice (or the relevant warehouse of the Seller) from which the Buyer is to take over the goods, the risk of damage to the goods passes to the Buyer upon handing over the goods to this carrier.
- 5.3. In the event that the Seller is to send the goods to the Buyer, the risk of damage to the goods passes to the Buyer at the time of delivery of the goods to the first carrier for transport to the destination.
- 5.4. The Buyer is obliged to inspect the goods without undue delay after the risk of damage to the goods has passed. If the goods are sent to the Buyer, the Buyer is obliged to inspect the goods without undue delay after their delivery to the destination. The company KJG a.s. reserves the right to change prices, packaging and printing.

VI. LIABILITY FOR DEFECTS AND WARRANTY

- 6.1. The Seller shall be responsible for the defect by which the goods have been affected at the moment when the risk of damage to the goods passes to the Buyer, even if the defect becomes apparent only after this time. The Seller is also responsible for any defect arising after the risk of damage to the goods has passed to the Buyer if caused by a breach of the Buyer's duties.
- 6.2. If the Buyer does not inspect the goods or does not arrange to inspect them at the time of passing the risk of damage to the goods, the Buyer may claim for defects detectable during this inspection only if the Buyer proves that the goods were already affected by these defects at the time of passing the risk of damage to the goods.
- 6.3. The Buyer shall be obliged to notify the Seller of defects in the goods without undue delay after:
 - a/ The Buyer found the defects,
 - b/ The Buyer, while exercising professional care, should have found defects during the inspection, which the Buyer is obliged to carry out after the risk of damage to the goods has passed, or
 - c/ The defects could be found later with the exercise of professional care, but no later than within two years from the time of delivery of the goods, or from the arrival of the goods to the destination specified in the contract. For defects covered by the quality warranty, instead of this period of time the warranty period applies.
- 6.4. If the Seller provides the Buyer with a warranty for the quality of the delivered goods, it shall do so by making a statement in a separate warranty card, which will also state the procedure for complaints.
- 6.5. The warranty period begins to run from the date of delivery of the goods. If the Seller is obliged to send the goods, the warranty period runs from the day the goods arrive at its destination. The warranty period does not run for a period during which the Buyer cannot use the goods due to their defects, which is the Seller's responsibility.
- 6.6. In the case of delivery of goods to the Buyer with defects, the use of prov. § 436, § 437, § 439 par. 2, 3, 4 and § 441 of the Commercial Code are explicitly excluded and the Seller in such a case shall provide the Buyer with a discount on the purchase price or shall remove the defects in the goods complained by the Buyer:
 - a/ by delivery of missing goods,
 - b/ by repair of goods or delivery of replacement goods in case of remediable defects
 - c/ by delivery of replacement goods in the event of irreparable defects.
- 6.7. The discount granted by the Seller on the purchase price shall correspond to the difference between the value of the goods without defects and the value of the goods delivered with defects, while the decisive time for determining the values is the time at which proper fulfillment should have taken place. The Buyer, to whom the Seller has been granted a discount on the purchase price, is not entitled to claim compensation for the loss of profit due to the lack of properties of the goods to which the discount applies.
- 6.8. Upon delivery of replacement goods, the Seller shall be entitled to demand the exchanged goods to be returned to the Seller at the Buyer's expense in the condition in which they were delivered to the Buyer. This does not apply if the impossibility of returning the goods in the condition specified therein is not caused by the actions or omissions of the Buyer, or if the change in the condition of the goods occurred as a result of an inspection duly performed to detect defects in the goods. In the event that before the detection of defects the Buyer sold the goods or part thereof or consumed the goods in whole or in part or altered them in their normal use, the Buyer shall be obliged to return unsold or unconsumed goods or altered goods and provide the Seller with compensation to the extent to which the Seller has benefited from that use of the goods.
- 6.9. The Seller's responsibility for defects not covered by the quality warranty does not arise if these defects were caused after the passing of the risk of damage to the goods by external events and were not caused by the Seller or the persons who helped to fulfil the Seller's obligation.

VII. VIS MAJOR

- 7.1. If, after the conclusion of the contract, unforeseeable and uncontrollable circumstances arise which create a permanent or temporary obstacle to the fulfillment of the obligations of the contracting parties of the concluded contract (refer to vis major), the non-fulfillment of obligations (in case of permanent obstacle) by a contracting party, or a delayed fulfillment of obligations (in case of temporary obstacle), shall not be considered a breach of this contract and the contracting party shall not be responsible for any damages that arise in connection with non-fulfillment of contractual obligations. If the obstacle incurred is only temporary for the fulfillment of obligations under the contract, the contracting parties undertake to start fulfilling their contractual obligations immediately after this obstacle disappears. Each contracting party shall be obliged to inform immediately the other contracting party of the occurrence of the above obstacles.
- 7.2. The followings are mainly considered to be vis major: natural events, arbitrary acts of third parties, strikes, work lockouts, blockades, wars (declared or undeclared), a change in the political situation or any other similar event which precludes or unduly impedes the exercise of rights and obligations under the contract.

VIII. PRIVACY POLICY

- 8.1. The Buyer (for the purposes of this article also another person signed on the FPC and the order on behalf of the Buyer) expressly grants to the Seller, according to Act no. 428/2002 Coll. on personal data protection as amended (hereinafter referred to as the „Act“), consent to the processing of its personal data specified in the FPC and the Buyer's order.
- 8.2. The Buyer expressly authorizes the Seller to process personal data for the purposes of:
 - a/ exercise of the rights and obligations arising from the FPC and IPC,
 - b/ keeping records, the obligation of which arises for the Seller by law or on the basis of the Act,
 - c/ performing marketing activities.
- 8.3. The Buyer expressly gives the Seller consent to provide the Buyer's personal data for the purposes stated in point 8.2 to a third party which has been entrusted by the Buyer with the activity in question.
- 8.4. The Buyer expressly grants the Seller consent to the processing of personal data:
 - a/ for the period in which the Seller is obliged to keep the records referred to in point 8.2. b /,
 - c/ for the period in which it is necessary to protect the legal rights and legally protected interests of the Seller.
- 8.5. The Buyer takes into account that it has the right to revoke its consent to the processing of personal data and require the liquidation of its personal data in the event that the Seller, or a third party to whom the Seller has provided personal data, respectively, breaches the obligations arising from the Act.

IX. FINAL PROVISIONS

- 9.1. The Buyer is not entitled to transfer or assign the rights resulting for the Buyer from the FPC or IPC to a third party without the express consent of the Seller.
- 9.2. The FPC may be amended, unless otherwise provided in these General Terms and Conditions, only in the form of written amendments signed by representatives of both the contracting parties.
- 9.3. The agreed deviating provisions in the IPC between the Seller and the Buyer take precedence over the provisions of the FPC and these General Terms and Conditions. Legal relations that are not regulated in the FPC, IPC or in these General Terms and Conditions are governed by the Commercial Code and other generally binding legal regulations in force in the Slovak Republic, excluding the use of conflicting rules of law and the application of the UN Convention on Contracts for the International Sale of Goods /CISG/ of April 11, 1980 and their possible amendments in the case the Buyer has its registered office (place of business) in another state or the goods are delivered to another state.
- 9.4. All disputes arising from the implementation of the content of the FPC will be resolved by the contracting parties through an amicable settlement. Disputes that cannot be resolved by mutual agreement are entitled to be resolved (exclusively) by the competent court in the Slovak Republic.
- 9.5. These General Terms and Conditions are issued by the Seller pursuant to § 273 of the Commercial Code, with effect from January 1, 2017.