

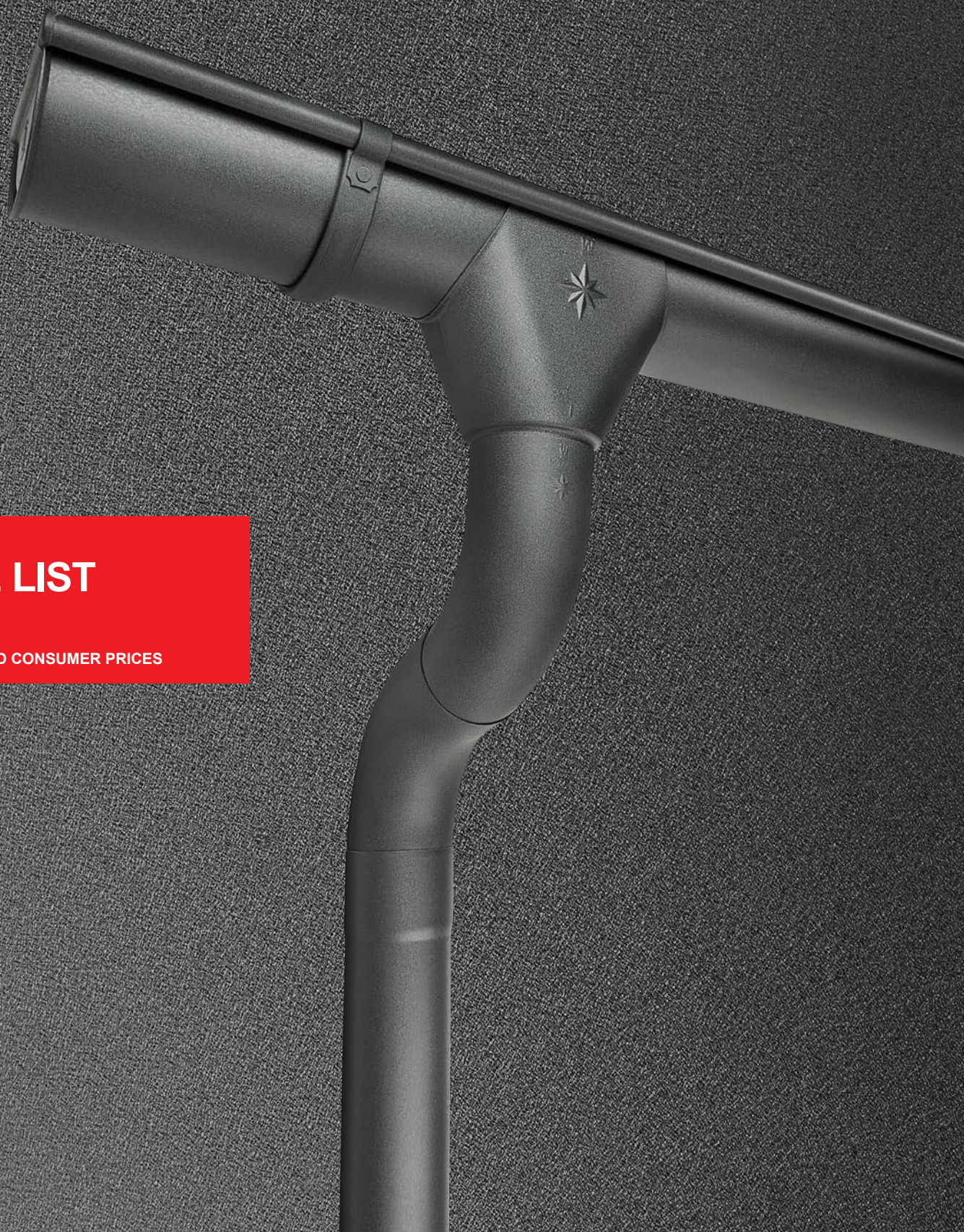

GUTTER SYSTEM SEMI CIRCULAR – CIRCULAR



PRICE LIST

2024

RECOMMENDED CONSUMER PRICES



POWERFUL PARTNER FOR YOUR ROOF



Aluminium material | 5



Gutter | 7

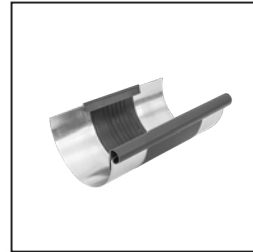

Gutter expanders | 9



Gutter accessories | 12



Gutter hook | 14

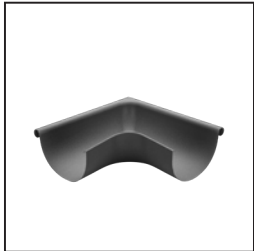

Corner | 17



End Cap | 19



Outlet | 20



Elbow | 30



Downpipe | 33



Downpipe accessories | 35



Pipe bracket | 37

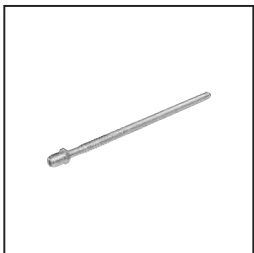

Pipe bracket accessories | 38



Downpipe flap | 41



Protective gutter pipe | 44



GUTTER SYSTEM SEMI CIRCULAR – CIRCULAR

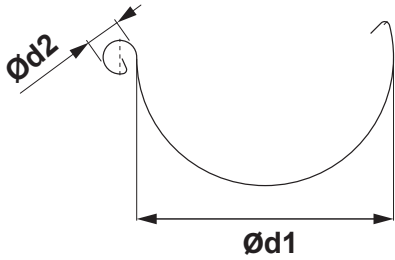

ROOF GUTTER DIMENSIONS

(dimensions and dimensional tolerances according to EN 612)

Developed width (mm)	250	280	333
Ød1	105	127	153
Ød2	18	18	20

INNER FALZ

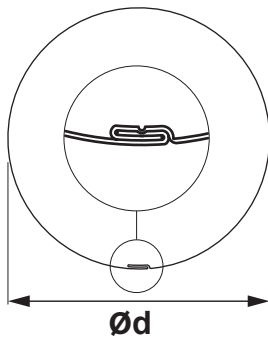

SPOUT PIPE DIMENSIONS

(dimensions and dimensional tolerances according to EN 612)

Dimensions	80	100	120
Nominal size Ød (mm)	80	100	120

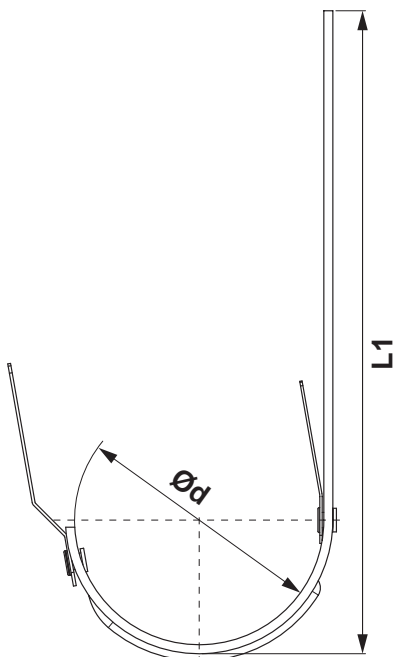

GUTTER BRACKET DIMENSIONS

(dimensions and dimensional tolerances according to EN 612)

Dimensions (mm)	L1	Ød
250	310	105
280	337	127
333 – 550	385	153

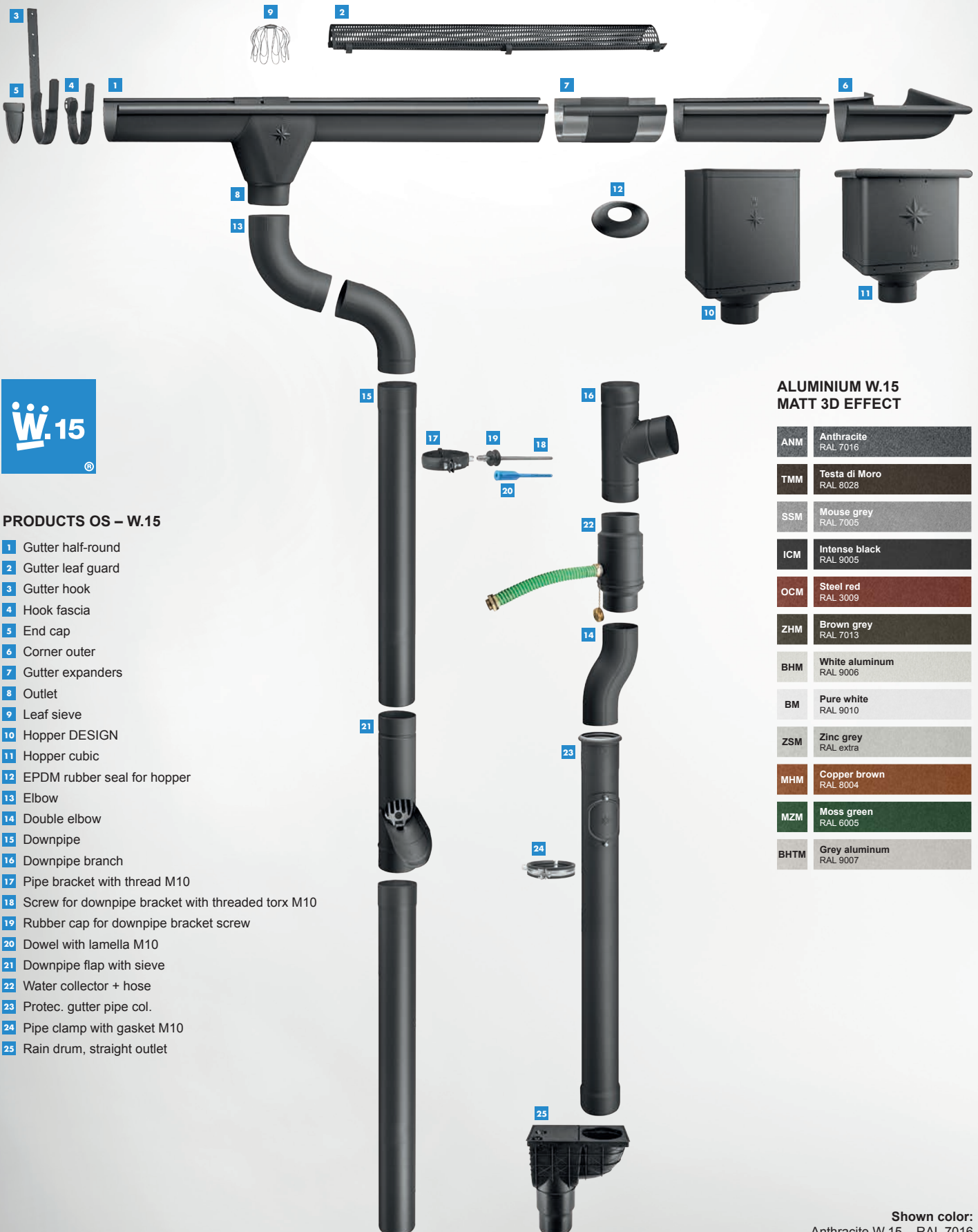

PRODUCTS OS – W.15

- 1 Gutter half-round
- 2 Gutter leaf guard
- 3 Gutter hook
- 4 Hook fascia
- 5 End cap
- 6 Corner outer
- 7 Gutter expanders
- 8 Outlet
- 9 Leaf sieve
- 10 Hopper DESIGN
- 11 Hopper cubic
- 12 EPDM rubber seal for hopper
- 13 Elbow
- 14 Double elbow
- 15 Downpipe
- 16 Downpipe branch
- 17 Pipe bracket with thread M10
- 18 Screw for downpipe bracket with threaded torx M10
- 19 Rubber cap for downpipe bracket screw
- 20 Dowel with lamella M10
- 21 Downpipe flap with sieve
- 22 Water collector + hose
- 23 Protec. gutter pipe col.
- 24 Pipe clamp with gasket M10
- 25 Rain drum, straight outlet

**ALUMINIUM W.15
MATT 3D EFFECT**

ANM	Anthracite RAL 7016
TMM	Testa di Moro RAL 8028
SSM	Mouse grey RAL 7005
ICM	Intense black RAL 9005
OCM	Steel red RAL 3009
ZHM	Brown grey RAL 7013
BHM	White aluminum RAL 9006
BM	Pure white RAL 9010
ZSM	Zinc grey RAL extra
MHM	Copper brown RAL 8004
MZM	Moss green RAL 6005
BHTM	Grey aluminum RAL 9007





ALUMINIUM W.15 MATT 3D EFFECT

SPEIRA

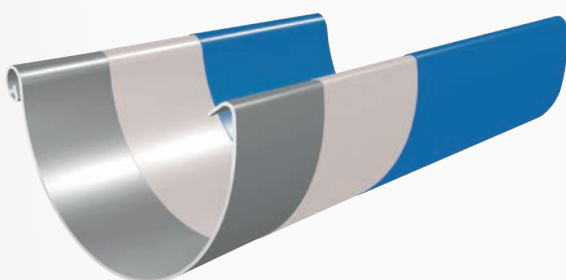
Speira is a global aluminium rolling and recycling company. It consists of seven manufacturing facilities, as well as one research and development centre. They are located in Germany and Norway including our Joint Venture Alunorf, the largest aluminium rolling mill in the world, Grevenbroich, the largest rolled aluminium finishing mill in the world, as well as several international sales offices. Speira employs around 5,000 people mainly in Germany and Norway.



-  Top coating layer (approx. 20 μm) on a polyurethane base for excellent aesthetics and the highest resistance to damage, MATT 3D effect
-  Primer (approx. 5 μm) for perfect adhesion and strong anti-corrosion protection
-  Optimized aluminum coil for gutter system OS – W.15



ALUMINIUM MATERIAL WITH STYLISH MATT SURFAC



W.15

- ◆ High-quality paint with lotus effect
- ◆ High level of scratch resistance
- ◆ High colour consistency
- ◆ W.15 – twelve colour versions
- ◆ 40-year warranty on material and color

ALUMINIUM W.15

MATT 3D EFFECT

GUTTER HALF-ROUND [s=0,70]

W.15-WZ

Nominal dimension	250	280	333	333
Length in m	4,0	4,0	4,0	6,0
Price in €/m	With VAT	With VAT	With VAT	With VAT
ANM 1 Anthracite RAL 7016	7,38	9,30	9,36	9,36
	094001	094018	094025	094032
TMM 2 Testa di Moro RAL 8028	7,38	9,30	9,36	9,36
	100030	100047 *	100054	100061
SSM 3 Mouse grey RAL 7005	7,38	9,30	9,36	9,36
	099990	100009	100016	100023
ICM 4 Intense black RAL 9005	7,38	9,30	9,36	9,36
	114662	114679	114686	114693
OCM 5 Steel red RAL 3009	7,38	9,30	9,36	9,36
	114709	114716 *	114723 *	114730
ZHM 6 Brown grey RAL 7013	7,38	9,30	9,36	9,36
	111982	111999	112002	112019
BHM 7 White aluminum RAL 9006	7,38	9,30	9,36	9,36
	114624	114631 *	114648	114655
BM 8 Pure white RAL 9010	7,38	9,30	9,36	9,36
	132833 *	132888 *	132932	132949
ZSM 9 Zinc grey RAL extra	7,38	9,30	9,36	9,36
	132796 *	132840 *	132895 *	132987 *
MHM 10 Copper brown RAL 8004	7,38	9,30	9,36	9,36
	132819 *	132864 *	132918 *	132963 *
MZM 11 Moss green RAL 6005	7,38	9,30	9,36	9,36
	132802 *	132857 *	132901 *	132970 *
BHTM 12 Grey aluminum RAL 9007	7,38	9,30	9,36	9,36
	132826 *	132871 *	132925 *	132956 *
Package in m	20	20	20	30
Package in m	960	840	660	990

* Custom production





ALUMINIUM W.15

MATT 3D EFFECT

GUTTER ON-ROOF [s=0,70]

W.15-WZS



Nominal dimension	650	
Length in m	6,0	
Price in €/m	With VAT	
ANM 1 Anthracite RAL 7016	24,12	094179
TMM 2 Testa di Moro RAL 8028	24,12	100214 *
SSM 3 Mouse grey RAL 7005	24,12	100221 *
ICM 4 Intense black RAL 9005	24,12	114471 *
OCM 5 Steel red RAL 3009	24,12	114488 *
ZHM 6 Brown grey RAL 7013	24,12	112125 *
BHM 7 White aluminum RAL 9006	24,12	114495 *
BM 8 Pure white RAL 9010	24,12	137500 *
ZSM 9 Zinc grey RAL extra	24,12	137531 *
MHM 10 Copper brown RAL 8004	24,12	137517 *
MZM 11 Moss green RAL 6005	24,12	137524 *
BHTM 12 Grey aluminum RAL 9007	24,12	137494 *
Package in m 	6	
Package in m 	300	

* Custom production



ALUMINIUM W.15

MATT 3D EFFECT

GUTTER EXPANDERS

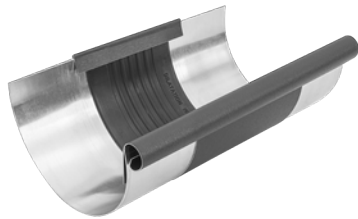
W.15-WZDI



Nominal dimension	250/260	285/260	333/260
Price in €/pcs	With VAT	With VAT	With VAT
ANM 1 Anthracite RAL 7016	25,56 093356 *	26,82 093363 *	26,82 093370
TMM 2 Testa di Moro RAL 8028	25,56 098702 *	26,82 098719 *	26,82 098726
SSM 3 Mouse grey RAL 7005	25,56 098818 *	26,82 098825 *	26,82 098832 *
ICM 4 Intense black RAL 9005	25,56 118738 *	26,82 118745 *	26,82 118752
OCM 5 Steel red RAL 3009	25,56 118769 *	26,82 118776 *	26,82 118783 *
ZHM 6 Brown grey RAL 7013	25,56 111401 *	26,82 111418 *	26,82 111432
BHM 7 White aluminum RAL 9006	25,56 118707 *	26,82 118714 *	26,82 118721 *
BM 8 Pure white RAL 9010	25,56 137029 *	26,82 137036 *	26,82 137043 *
ZSM 9 Zinc grey RAL extra	25,56 137111 *	26,82 137128 *	26,82 137135 *
MHM 10 Copper brown RAL 8004	25,56 137050 *	26,82 137067 *	26,82 137074 *
MZM 11 Moss green RAL 6005	25,56 137081 *	26,82 137098 *	26,82 137104 *
BHTM 12 Grey aluminum RAL 9007	25,56 136992 *	26,82 137005 *	26,82 137012 *
Package in pcs 	3	3	5
Package in pcs 	360	360	200



* Custom production

ALUMINIUM W.15

MATT 3D EFFECT

ON-ROOF GUTTER EXPANSION COMPONENT

W.15-WZSDI

Nominal dimension	670/260	
Price in €/pcs	With VAT	
ANM 1 Anthracite RAL 7016	81,12	093400 *
TMM 2 Testa di Moro RAL 8028	81,12	098757 *
SSM 3 Mouse grey RAL 7005	81,12	098863 *
ICM 4 Intense black RAL 9005	81,12	118806 *
OCM 5 Steel red RAL 3009	81,12	118813 *
ZHM 6 Brown grey RAL 7013	81,12	111425 *
BHM 7 White aluminum RAL 9006	81,12	118790 *
BM 8 Pure white RAL 9010	81,12	137555 *
ZSM 9 Zinc grey RAL extra	81,12	137586 *
MHM 10 Copper brown RAL 8004	81,12	137562 *
MZM 11 Moss green RAL 6005	81,12	137579 *
BHTM 12 Grey aluminum RAL 9007	81,12	137548 *
Package in pcs 	1	
Package in pcs 	40	

* Custom production



ALUMINIUM
W.15

USE OF DILATATION GUTTER AND DILATATION STRIP

DILATATION GUTTER

Installation example: hanging gutter with a developed width of up to 500 mm. The dilatation gutter shall be installed at spacing of 15 m. For outer corner and beginning of the gutter, a half of the standard value is applied: maximum 7,5 m. For inner corner, a quarter of the standard value is applied: maximum 3,75 m. For other materials and dimensions: see the table below. Corners are always taken into account as fixed points.

ROOF SEMICIRCULAR DILATATION GUTTERS

Developed gutter width	Aluminium	Steel, Titanium-zinc, Copper, Stainless steel
< 500	12	15
> 500	8	10

DILATATION STRIP

Indoor installation: on gutters attached without gluing to a substrate, roofs with non-standard profile and roof cladding

ROOF DILATATION STRIP

Developed gutter width	Aluminium	Steel, Titanium-zinc, Copper, Stainless steel
< 500	8	10
> 500	6	8

For outer corner or the beginning of the gutter, a half of the standard value shall be applied.

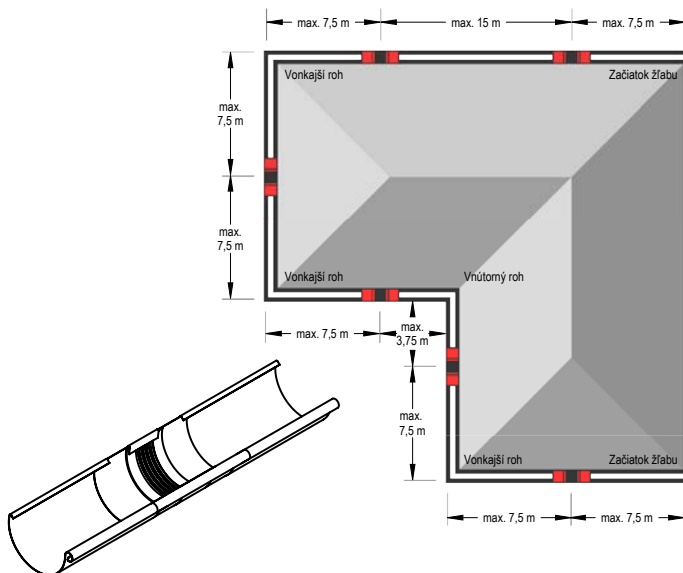

Note to the dilatation gutter mounting.

When mounting by soldering, first cover the middle rubber part with a wet cloth (to prevent heat transfer to the middle rubber part). A minimum distance of 6 cm from the middle rubber part must be kept. In any case avoid contact of rubber with open flame.

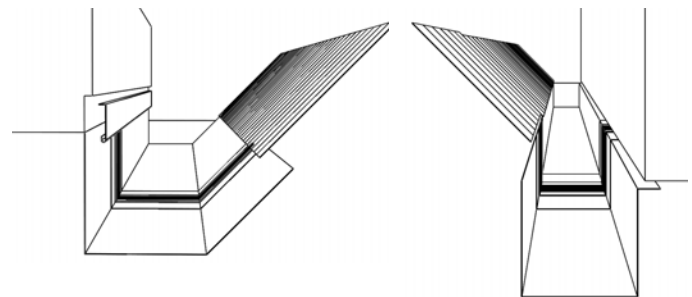

Note to the dilatation strip mounting.

When bending and mounting dilatation elements, make sure that:

- Bending jaws have a radius of at least 2 mm.
- For sheet metal thicknesses over 1 mm, it must be observed bending radius at least 5 mm.
- When bending, the bending jaws should be set to a thickness of the middle rubber part of 3 to 4 mm to prevent the cutting effect - damage to the rubber.
- The rubber middle part must not be compressed or damaged during bending. Therefore, an aluminium sheet strip 2 to 5 mm (thick) should be used, bent so that it can be attached as a protection to the bending jaws. This achieves a larger bending radius and prevents the rubber middle part from breaking.

ALUMINIUM W.15

MATT 3D EFFECT

GUTTER LEAF GUARD

W.15-WZNLM

Nominal dimension	333	
Length in m	2,0	
Price in €/pcs	With VAT	
ANM 1 Anthracite RAL 7016	32,40	097149 *
TMM 2 Testa di Moro RAL 8028	32,40	118035 *
SSM 3 Mouse grey RAL 7005	32,40	118028 *
ICM 4 Intense black RAL 9005	32,40	118004 *
OCM 5 Steel red RAL 3009	32,40	118011 *
ZHM 6 Brown grey RAL 7013	32,40	118042 *
BHM 7 White aluminum RAL 9006	32,40	117991 *
BM 8 Pure white RAL 9010	32,40	137142 *
ZSM 9 Zinc grey RAL extra	32,40	137173 *
MHM 10 Copper brown RAL 8004	32,40	137159 *
MZM 11 Moss green RAL 6005	32,40	137166 *
BHTM 12 Grey aluminum RAL 9007	32,40	137180 *
Package in pcs	15	
Package in pcs	120	

* Custom production

ALUMINIUM
W.15

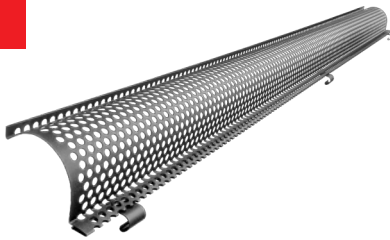



ALUMINIUM W.15

MATT 3D EFFECT

PVC GUTTER GUARD

SD-ZNL MRIEZKA

Nominal dimension	Lenght in m	EAN product number	Packaging in pcs		Price with VAT [€/pcs]
PS 171	1,0	008473	30	450	5,40
TM 171	1,0	008466	30	450	5,40

PVC GUTTER GUARD

SD-ZNL N

Nominal dimension	Lenght in m	EAN product number	Packaging in pcs		Price with VAT [€/pcs]
250	3,0	008480	10	400	28,68
280-333	3,0	008497	10	400	28,80

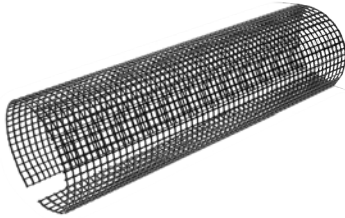
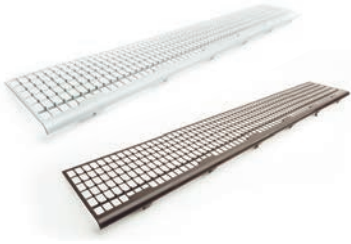

ALUMINIUM W.15

MATT 3D EFFECT

GUTTER HOOK

W.15-WHP

Nominal dimension	250/430	280/480	333/550
Material	23/7	28/7	28/7
Price in €/pcs	With VAT	With VAT	With VAT
ANM 1 Anthracite RAL 7016	4,26 093455	4,86 093462	5,34 093479
TMM 2 Testa di Moro RAL 8028	4,26 098986	4,86 098993	5,34 099006
SSM 3 Mouse grey RAL 7005	4,26 098955	4,86 098962	5,34 098979
ICM 4 Intense black RAL 9005	4,26 116475	4,86 116482	5,34 116499
OCM 5 Steel red RAL 3009	4,26 116505	4,86 116512 *	5,34 116529
ZHM 6 Brown grey RAL 7013	4,26 111449	4,86 111456	5,34 111463
BHM 7 White aluminum RAL 9006	4,26 116444 *	4,86 116451 *	5,34 116468
BM 8 Pure white RAL 9010	4,26 133083 *	4,86 133090 *	5,34 133106
ZSM 9 Zinc grey RAL extra	4,26 133175 *	4,86 133182 *	5,34 133199 *
MHM 10 Copper brown RAL 8004	4,26 133113	4,86 133120 *	5,34 133137
MZM 11 Moss green RAL 6005	4,26 133144 *	4,86 133151 *	5,34 133168 *
BHTM 12 Grey aluminum RAL 9007	4,26 133052 *	4,86 133069 *	5,34 133076 *
Package in pcs	15	15	15
Package in pcs	600	600	600

* Custom production





ALUMINIUM
W.15

ALUMINIUM W.15

MATT 3D EFFECT

HOOK FASCIA

W.15-WHPK

Nominal dimension	250	280	333
Material	28/7	28/7	28/7
Price in €/pcs	With VAT	With VAT	With VAT
ANM 1 Anthracite RAL 7016	4,80 093486	4,86 093493	4,92 093509
TMM 2 Testa di Moro RAL 8028	4,80 099020 *	4,86 099044 *	4,92 099068
SSM 3 Mouse grey RAL 7005	4,80 099013 *	4,86 099037 *	4,92 099051
ICM 4 Intense black RAL 9005	4,80 118448 *	4,86 118455 *	4,92 118462 *
OCM 5 Steel red RAL 3009	4,80 118479 *	4,86 118486 *	4,92 118493 *
ZHM 6 Brown grey RAL 7013	4,80 111470 *	4,86 111487 *	4,92 111494
BHM 7 White aluminum RAL 9006	4,80 118417 *	4,86 118424 *	4,92 118431 *
BM 8 Pure white RAL 9010	4,80 133250 *	4,86 133267 *	4,92 133274 *
ZSM 9 Zinc grey RAL extra	4,80 133342 *	4,86 133359 *	4,92 133366 *
MHM 10 Copper brown RAL 8004	4,80 133281 *	4,86 133298 *	4,92 133304 *
MZM 11 Moss green RAL 6005	4,80 133311 *	4,86 133328 *	4,92 133335 *
BHTM 12 Grey aluminum RAL 9007	4,80 133229 *	4,86 133236 *	4,92 133243 *
Package in pcs 	15	15	15
Package in pcs 	600	600	600

* Custom production





ALUMINIUM W.15

MATT 3D EFFECT

ON-ROOF GUTTER HOOK WITH SUPPORT

W.15-WHSG

Nominal dimension	4	
Material	28/7	
Price in €/pcs	With VAT	
ANM 1 Anthracite RAL 7016	11,16	093516
TMM 2 Testa di Moro RAL 8028	11,16	099082 *
SSM 3 Mouse grey RAL 7005	11,16	099075 *
ICM 4 Intense black RAL 9005	11,16	114600 *
OCM 5 Steel red RAL 3009	11,16	114617 *
ZHM 6 Brown grey RAL 7013	11,16	111500 *
BHM 7 White aluminum RAL 9006	11,16	114594 *
BM 8 Pure white RAL 9010	11,16	135605 *
ZSM 9 Zinc grey RAL extra	11,16	135636 *
MHM 10 Copper brown RAL 8004	11,16	135612 *
MZM 11 Moss green RAL 6005	11,16	135629 *
BHTM 12 Grey aluminum RAL 9007	11,16	135599 *
Package in pcs 	10	
Package in pcs 	400	

* Custom production





ALUMINIUM
W.15

ALUMINIUM W.15

MATT 3D EFFECT

CORNER OUTER

W.15-WRA

Nominal dimension	250	280	333
Price in €/pcs	With VAT	With VAT	With VAT
ANM 1 Anthracite RAL 7016	18,48 093905	19,32 093912	20,22 093929
TMM 2 Testa di Moro RAL 8028	18,48 099822	19,32 099839 *	20,22 099846
SSM 3 Mouse grey RAL 7005	18,48 099792	19,32 099808	20,22 099815
ICM 4 Intense black RAL 9005	18,48 118868	19,32 118875	20,22 118882
OCM 5 Steel red RAL 3009	18,48 118899 *	19,32 118905 *	20,22 118912 *
ZHM 6 Brown grey RAL 7013	18,48 111876	19,32 111883 *	20,22 111890
BHM 7 White aluminum RAL 9006	18,48 118837 *	19,32 118844 *	20,22 118851 *
BM 8 Pure white RAL 9010	18,48 136725 *	19,32 136732 *	20,22 136749
ZSM 9 Zinc grey RAL extra	18,48 136817 *	19,32 136824 *	20,22 136831 *
MHM 10 Copper brown RAL 8004	18,48 136756	19,32 136763 *	20,22 136770
MZM 11 Moss green RAL 6005	18,48 136787 *	19,32 136794 *	20,22 136800 *
BHTM 12 Grey aluminum RAL 9007	18,48 136695 *	19,32 136701 *	20,22 136718 *
Package in pcs 	5	5	5
Package in pcs 	150	150	150

* Custom production

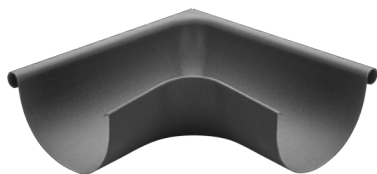



ALUMINIUM W.15

MATT 3D EFFECT

CORNER INNER

W.15-WRI

Nominal dimension	250	280	333
Price in €/pcs	With VAT	With VAT	With VAT
ANM 1 Anthracite RAL 7016	18,48 093950	19,32 093967	20,22 093974
TMM 2 Testa di Moro RAL 8028	18,48 099884 *	19,32 099891 *	20,22 099907
SSM 3 Mouse grey RAL 7005	18,48 099853	19,32 099860	20,22 099877
ICM 4 Intense black RAL 9005	18,48 118950 *	19,32 118967 *	20,22 118974
OCM 5 Steel red RAL 3009	18,48 118981 *	19,32 118998 *	20,22 119001 *
ZHM 6 Brown grey RAL 7013	18,48 111906 *	19,32 111913 *	20,22 111920
BHM 7 White aluminum RAL 9006	18,48 118929 *	19,32 118936 *	20,22 118943 *
BM 8 Pure white RAL 9010	18,48 136879 *	19,32 136886 *	20,22 136893
ZSM 9 Zinc grey RAL extra	18,48 136961 *	19,32 136978 *	20,22 136985 *
MHM 10 Copper brown RAL 8004	18,48 136909 *	19,32 136916 *	20,22 136923
MZM 11 Moss green RAL 6005	18,48 136930 *	19,32 136947 *	20,22 136954 *
BHTM 12 Grey aluminum RAL 9007	18,48 136848 *	19,32 136855 *	20,22 136862 *
Package in pcs 	5	5	5
Package in pcs 	150	150	150

* Custom production

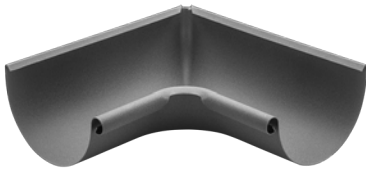



ALUMINIUM W.15

MATT 3D EFFECT

END CAP

W.15-WCL



Nominal dimension	250	280	333
Price in €/pcs	With VAT	With VAT	With VAT
ANM 1 Anthracite RAL 7016	1,86 093301	1,92 093318	1,98 093325
TMM 2 Testa di Moro RAL 8028	1,86 098658 *	1,92 098665 *	1,98 098672
SSM 3 Mouse grey RAL 7005	1,86 098764	1,92 098771	1,98 098788
ICM 4 Intense black RAL 9005	1,86 118356	1,92 118363	1,98 118370
OCM 5 Steel red RAL 3009	1,86 118387 *	1,92 118394 *	1,98 118400
ZHM 6 Brown grey RAL 7013	1,86 111371 *	1,92 111388 *	1,98 111395
BHM 7 White aluminium RAL 9006	1,86 118325 *	1,92 118332 *	1,98 118349
BM 8 Pure white RAL 9010	1,86 135476 *	1,92 135483 *	1,98 135490
ZSM 9 Zinc grey RAL extra	1,86 135568 *	1,92 135575 *	1,98 135582 *
MHM 10 Copper brown RAL 8004	1,86 135506	1,92 135513 *	1,98 135520
MZM 11 Moss green RAL 6005	1,86 135537 *	1,92 135544 *	1,98 135551 *
BHTM 12 Grey aluminium RAL 9007	1,86 135445 *	1,92 135452 *	1,98 135469 *
Package in pcs 	6/60	6/60	6/60
Package in pcs 	1 440	1 440	1 440

* Custom production



ALUMINIUM W.15

MATT 3D EFFECT

OUTLET

W.15-WKL



Nominal dimension	250/80	280/80	280/100
Price in €/pcs	With VAT	With VAT	With VAT
ANM 1 Anthracite RAL 7016	14,10 093585	16,20 093592 *	15,60 093608
TMM 2 Testa di Moro RAL 8028	14,10 099273	16,20 099280 *	15,60 099297
SSM 3 Mouse grey RAL 7005	14,10 099211	16,20 099228 *	15,60 099235
ICM 4 Intense black RAL 9005	14,10 116864	16,20 116871 *	15,60 116888
OCM 5 Steel red RAL 3009	14,10 116925 *	16,20 116932 *	15,60 116949 *
ZHM 6 Brown grey RAL 7013	14,10 111579	16,20 111586 *	15,60 111593
BHM 7 White aluminum RAL 9006	14,10 116802 *	16,20 116819 *	15,60 116826 *
BM 8 Pure white RAL 9010	14,10 135858 *	16,20 135865 *	15,60 135872 *
ZSM 9 Zinc grey RAL extra	14,10 136039 *	16,20 136046 *	15,60 136053 *
MHM 10 Copper brown RAL 8004	14,10 135919	16,20 135926 *	15,60 135933 *
MZM 11 Moss green RAL 6005	14,10 135971 *	16,20 135988 *	15,60 135995 *
BHTM 12 Grey aluminum RAL 9007	14,10 135797 *	16,20 135803 *	15,60 135810 *
Package in pcs 	15	15	15
Package in pcs 	300	450	450

* Custom production

ALUMINIUM W.15

MATT 3D EFFECT

OUTLET

W.15-WKL

Nominal dimension	333/80	333/100	333/120
Price in €/pcs	With VAT	With VAT	With VAT
ANM 1 Anthracite RAL 7016	16,74 093615 *	17,10 093622	22,44 093639
TMM 2 Testa di Moro RAL 8028	16,74 099303 *	17,10 099310	22,44 099327
SSM 3 Mouse grey RAL 7005	16,74 099242 *	17,10 099259	22,44 099266
ICM 4 Intense black RAL 9005	16,74 116895 *	17,10 116901	22,44 116918 *
OCM 5 Steel red RAL 3009	16,74 116956 *	17,10 116963 *	22,44 116970 *
ZHM 6 Brown grey RAL 7013	16,74 111609 *	17,10 111616	22,44 111623
BHM 7 White aluminum RAL 9006	16,74 116833 *	17,10 116840 *	22,44 116857 *
BM 8 Pure white RAL 9010	16,74 135889 *	17,10 135896	22,44 135902 *
ZSM 9 Zinc grey RAL extra	16,74 136060 *	17,10 136077 *	22,44 136084 *
MHM 10 Copper brown RAL 8004	16,74 135940	17,10 135957	22,44 135964
MZM 11 Moss green RAL 6005	16,74 136008 *	17,10 136015 *	22,44 136022 *
BHTM 12 Grey aluminum RAL 9007	16,74 135827 *	17,10 135834 *	22,44 135841 *
Package in pcs 📦	15	15	10
Package in pcs 🚚	450	450	200

* Custom production





ALUMINIUM W.15

MATT 3D EFFECT

NEW CLAMPING SYSTEM FEDER ENABLES TO TURN THE ELBOW EASY IN THE DESIRED DIRECTION AND HOLDS RELIABLY IN ANY POSITION. EASY INSTALLATION TO ANY ELBOW WITHOUT RIVETING.



1



2



3

ALUMINIUM
W.15





ALUMINIUM W.15

MATT 3D EFFECT

STAINLESS STEEL LEAF SIEVE

N-NZN



Nominal dimension	EAN product number	Packaging in pcs		Price with VAT [€/pcs]
60	001153	30	2 160	6,66
80	001160	20	1 440	6,72
100	001177	15	1 080	6,84
120	001184	10	720	7,44
150	001191	5	360	11,76



ALUMINIUM W.15



MATT 3D EFFECT

HOPPER DESIGN

W.15-WKLZ DE



ALUMINIUM
W.15

Nominal dimension	80	100	120
Price in €/pcs	With VAT	With VAT	With VAT
ANM 1 Anthracite RAL 7016	124,68 093677 *	124,68 093721	131,04 093776 *
TMM 2 Testa di Moro RAL 8028	124,68 100634 *	124,68 100689 *	131,04 100733 *
SSM 3 Mouse grey RAL 7005	124,68 100481 *	124,68 100535 *	131,04 100580 *
ICM 4 Intense black RAL 9005	124,68 138606 *	124,68 138651 *	131,04 138705 *
OCM 5 Steel red RAL 3009	124,68 139054 *	124,68 139108 *	131,04 139153 *
ZHM 6 Brown grey RAL 7013	124,68 111647 *	124,68 111692 *	131,04 111746 *
BHM 7 White aluminum RAL 9006	124,68 138156 *	124,68 138200 *	131,04 138255 *
BM 8 Pure white RAL 9010	124,68 138453 *	124,68 138507 *	131,04 138552 *
ZSM 9 Zinc grey RAL extra	124,68 139207 *	124,68 139252 *	131,04 139306 *
MHM 10 Copper brown RAL 8004	124,68 138750 *	124,68 138804 *	131,04 138859 *
MZM 11 Moss green RAL 6005	124,68 138903 *	124,68 138958 *	131,04 139009 *
BHTM 12 Grey aluminum RAL 9007	124,68 138309 *	124,68 138354 *	131,04 138408 *
Package in pcs 	2	2	2
Package in pcs 	36	36	36

* Custom production

ALUMINIUM W.15

MATT 3D EFFECT

HOPPER DESIGN ECCENTRIC

W.15-WKLZ DX



Nominal dimension	80	100	120
Price in €/pcs	With VAT	With VAT	With VAT
ANM 1 Anthracite RAL 7016	143,52	143,52	156,00
	093660 *	093714	093769 *
TMM 2 Testa di Moro RAL 8028	143,52	143,52	156,00
	100627 *	100672 *	100726 *
SSM 3 Mouse grey RAL 7005	143,52	143,52	156,00
	100474 *	100528 *	100573 *
ICM 4 Intense black RAL 9005	143,52	143,52	156,00
	138613 *	138668 *	138712 *
OCM 5 Steel red RAL 3009	143,52	143,52	156,00
	139061 *	139115 *	139160 *
ZHM 6 Brown grey RAL 7013	143,52	143,52	156,00
	111630 *	111685 *	111739 *
BHM 7 White aluminum RAL 9006	143,52	143,52	156,00
	138163 *	138217 *	138262 *
BM 8 Pure white RAL 9010	143,52	143,52	156,00
	138460 *	138514 *	138569 *
ZSM 9 Zinc grey RAL extra	143,52	143,52	156,00
	139214 *	139269 *	139313 *
MHM 10 Copper brown RAL 8004	143,52	143,52	156,00
	138767 *	138811 *	138866 *
MZM 11 Moss green RAL 6005	143,52	143,52	156,00
	138910 *	138965 *	139016 *
BHTM 12 Grey aluminum RAL 9007	143,52	143,52	156,00
	138316 *	138361 *	138415 *
Package in pcs	2	2	2
Package in pcs	36	36	36

* Custom production

ALUMINIUM W.15

MATT 3D EFFECT

HOPPER CUBIC

W.15-WKLZ KU

Nominal dimension	80	100	120
Price in €/pcs	With VAT	With VAT	With VAT
ANM 1 Anthracite RAL 7016	159,72 093684 *	159,72 093738 *	180,96 093783 *
TMM 2 Testa di Moro RAL 8028	159,72 100641 *	159,72 100696 *	180,96 100740 *
SSM 3 Mouse grey RAL 7005	159,72 100498 *	159,72 100542 *	180,96 100597 *
ICM 4 Intense black RAL 9005	159,72 138620 *	159,72 138675 *	180,96 138729 *
OCM 5 Steel red RAL 3009	159,72 139078 *	159,72 139122 *	180,96 139177 *
ZHM 6 Brown grey RAL 7013	159,72 111654 *	159,72 111708 *	180,96 111753 *
BHM 7 White aluminum RAL 9006	159,72 138170 *	159,72 138224 *	180,96 138279 *
BM 8 Pure white RAL 9010	159,72 138477 *	159,72 138521 *	180,96 138576 *
ZSM 9 Zinc grey RAL extra	159,72 139221 *	159,72 139276 *	180,96 139320 *
MHM 10 Copper brown RAL 8004	159,72 138774 *	159,72 138828 *	180,96 138873 *
MZM 11 Moss green RAL 6005	159,72 138927 *	159,72 138972 *	180,96 139023 *
BHTM 12 Grey aluminum RAL 9007	159,72 138323 *	159,72 138378 *	180,96 138422 *
Package in pcs	2	2	2
Package in pcs	36	36	36

* Custom production



ALUMINIUM
W.15



ALUMINIUM W.15

MATT 3D EFFECT

HOPPER CUBIC ECCENTRIC

W.15-WKLZ KX



Nominal dimension	80	100	120
Price in €/pcs	With VAT	With VAT	With VAT
ANM 1 Anthracite RAL 7016	168,48 093707 *	168,48 093752	180,96 093806 *
TMM 2 Testa di Moro RAL 8028	168,48 100665 *	168,48 100719	180,96 100764 *
SSM 3 Mouse grey RAL 7005	168,48 100511 *	168,48 100566	180,96 100610 *
ICM 4 Intense black RAL 9005	168,48 138637 *	168,48 138682 *	180,96 138736 *
OCM 5 Steel red RAL 3009	168,48 139085 *	168,48 139139 *	180,96 139184 *
ZHM 6 Brown grey RAL 7013	168,48 111678 *	168,48 111722	180,96 111777 *
BHM 7 White aluminum RAL 9006	168,48 138187 *	168,48 138231 *	180,96 138286 *
BM 8 Pure white RAL 9010	168,48 138484 *	168,48 138538 *	180,96 138583 *
ZSM 9 Zinc grey RAL extra	168,48 139238 *	168,48 139283 *	180,96 139337 *
MHM 10 Copper brown RAL 8004	168,48 138781 *	168,48 138835 *	180,96 138880 *
MZM 11 Moss green RAL 6005	168,48 138934 *	168,48 138989 *	180,96 139030 *
BHTM 12 Grey aluminum RAL 9007	168,48 138330 *	168,48 138385 *	180,96 138439 *
Package in pcs 	2	2	2
Package in pcs 	36	36	36



* Custom production

ALUMINIUM W.15

MATT 3D EFFECT

HOPPER CUBIC ECCENTRIC WITH OVERFLOW PIPE W.15-WKLZ KXV



Nominal dimension	80	100	120
Price in €/pcs	With VAT	With VAT	With VAT
ANM 1 Anthracite RAL 7016	199,68 093691 *	199,68 093745 *	212,16 093790 *
TMM 2 Testa di Moro RAL 8028	199,68 100658 *	199,68 100702 *	212,16 100757 *
SSM 3 Mouse grey RAL 7005	199,68 100504 *	199,68 100559 *	212,16 100603 *
ICM 4 Intense black RAL 9005	199,68 138644 *	199,68 138699 *	212,16 138743 *
OCM 5 Steel red RAL 3009	199,68 139092 *	199,68 139146 *	212,16 139191 *
ZHM 6 Brown grey RAL 7013	199,68 111661 *	199,68 111715 *	212,16 111760 *
BHM 7 White aluminum RAL 9006	199,68 138194 *	199,68 138248 *	212,16 138293 *
BM 8 Pure white RAL 9010	199,68 138491 *	199,68 138545 *	212,16 138590 *
ZSM 9 Zinc grey RAL extra	199,68 139245 *	199,68 139290 *	212,16 139344 *
MHM 10 Copper brown RAL 8004	199,68 138798 *	199,68 138842 *	212,16 138897 *
MZM 11 Moss green RAL 6005	199,68 138941 *	199,68 138996 *	212,16 139047 *
BHTM 12 Grey aluminum RAL 9007	199,68 138347 *	199,68 138392 *	212,16 138446 *
Package in pcs 	2	2	2
Package in pcs 	36	36	36

* Custom production

RUBBER SEAL FOR HOPPER

P-PKLZ T



Nominal dimension	EAN product number	Packaging in pcs		Price with VAT [€/pcs]
IC 70-85	077103	5	600	4,80
IC 100-110	077110	5	600	4,92
IC 110-125	077097	5	600	5,04
PS 70-85	077134	5	600	5,40
PS 100-110	077141	5	600	5,88
PS 110-125	077127	5	600	6,00

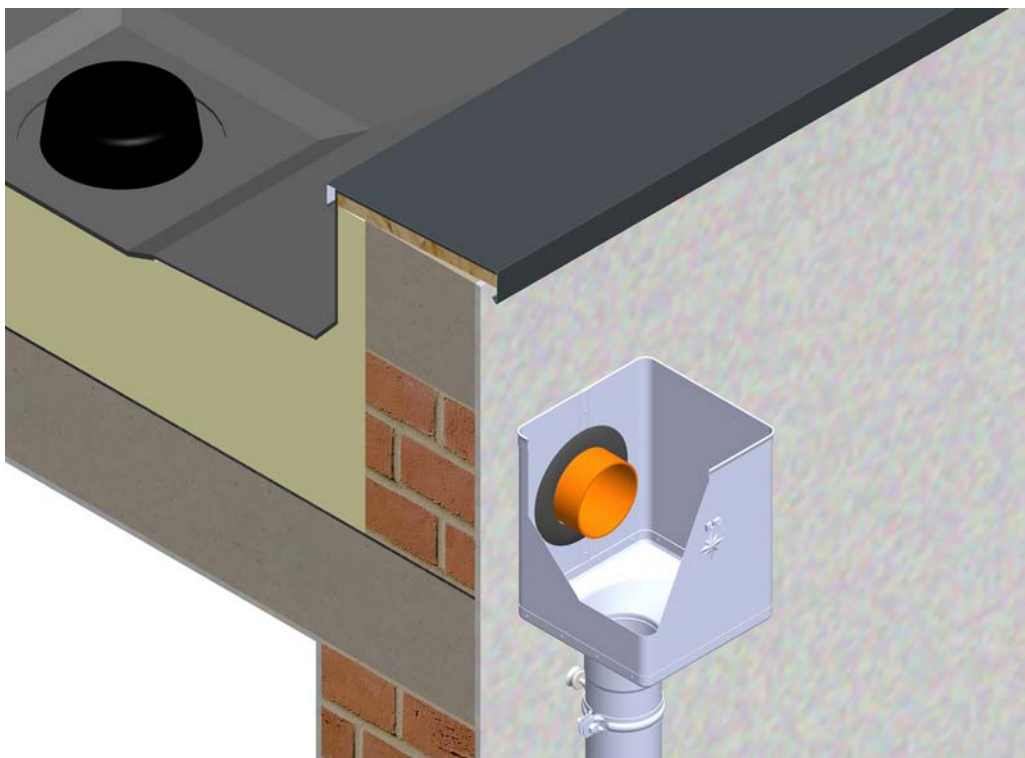

ALUMINIUM W.15

MATT 3D EFFECT

ELBOW 72°

W.15-WK



ALUMINIUM
W.15

Nominal dimension	80	100	120
Price in €/pcs	With VAT	With VAT	With VAT
ANM 1 Anthracite RAL 7016	11,22 093523	12,00 093547	18,24 093561
TMM 2 Testa di Moro RAL 8028	11,22 099129	12,00 099136	18,24 099143
SSM 3 Mouse grey RAL 7005	11,22 099099	12,00 099105	18,24 099112
ICM 4 Intense black RAL 9005	11,22 116567	12,00 116574	18,24 116581 *
OCM 5 Steel red RAL 3009	11,22 116598 *	12,00 116604 *	18,24 116611 *
ZHM 6 Brown grey RAL 7013	11,22 111517	12,00 111531	18,24 111555
BHM 7 White aluminum RAL 9006	11,22 116536 *	12,00 116543 *	18,24 116550 *
BM 8 Pure white RAL 9010	11,22 135674 *	12,00 135681	18,24 135698 *
ZSM 9 Zinc grey RAL extra	11,22 135766 *	12,00 135773 *	18,24 135780 *
MHM 10 Copper brown RAL 8004	11,22 135704	12,00 135711	18,24 135728
MZM 11 Moss green RAL 6005	11,22 135735 *	12,00 135742 *	18,24 135759 *
BHTM 12 Grey aluminum RAL 9007	11,22 135643 *	12,00 135650 *	18,24 135667 *
Package in pcs	4	4	2
Package in pcs	240	120	120

* Custom production



ALUMINIUM W.15

MATT 3D EFFECT

ELBOW RADIUS 85°

W.15-WKR



Nominal dimension	80	100	120
Price in €/pcs	With VAT	With VAT	With VAT
ANM 1 Anthracite RAL 7016	13,98 093530 *	17,46 093554	22,44 093578 *
TMM 2 Testa di Moro RAL 8028	13,98 099167 *	17,46 099181	22,44 099204 *
SSM 3 Mouse grey RAL 7005	13,98 099150 *	17,46 099174	22,44 099198 *
ICM 4 Intense black RAL 9005	13,98 116628 *	17,46 116635 *	22,44 116642 *
OCM 5 Steel red RAL 3009	13,98 116659 *	17,46 116666 *	22,44 116673 *
ZHM 6 Brown grey RAL 7013	13,98 111524 *	17,46 111548	22,44 111562 *
BHM 7 White aluminum RAL 9006	13,98 116680 *	17,46 116697 *	22,44 116703 *
BM 8 Pure white RAL 9010	13,98 136275 *	17,46 136282	22,44 136299 *
ZSM 9 Zinc grey RAL extra	13,98 136367 *	17,46 136374 *	22,44 136381 *
MHM 10 Copper brown RAL 8004	13,98 136305 *	17,46 136312 *	22,44 136329 *
MZM 11 Moss green RAL 6005	13,98 136336 *	17,46 136343 *	22,44 136350 *
BHTM 12 Grey aluminum RAL 9007	13,98 136224 *	17,46 136251 *	22,44 136268 *
Package in pcs 	4	4	4
Package in pcs 	240	120	120



* Custom production

ALUMINIUM W.15

MATT 3D EFFECT

ELBOW BLIND 40°

W.15-WKT

Nominal dimension	80	100	120
Price in €/pcs	With VAT	With VAT	With VAT
ANM 1 Anthracite RAL 7016	11,10 093844	13,74 093851	18,60 093868
TMM 2 Testa di Moro RAL 8028	11,10 099440	13,74 099464	18,60 099471 *
SSM 3 Mouse grey RAL 7005	11,10 099433	13,74 099457	18,60 099488 *
ICM 4 Intense black RAL 9005	11,10 116741 *	13,74 116758 *	18,60 116765 *
OCM 5 Steel red RAL 3009	11,10 116772 *	13,74 116789 *	18,60 116796 *
ZHM 6 Brown grey RAL 7013	11,10 111814	13,74 111821	18,60 111838 *
BHM 7 White aluminum RAL 9006	11,10 116710 *	13,74 116727 *	18,60 116734 *
BM 8 Pure white RAL 9010	11,10 136428 *	13,74 136435	18,60 136442 *
ZSM 9 Zinc grey RAL extra	11,10 136510 *	13,74 136527 *	18,60 136534 *
MHM 10 Copper brown RAL 8004	11,10 136459 *	13,74 136466 *	18,60 136473 *
MZM 11 Moss green RAL 6005	11,10 136480 *	13,74 136497 *	18,60 136503 *
BHTM 12 Grey aluminum RAL 9007	11,10 136398 *	13,74 136404 *	18,60 136411 *
Package in pcs 	4	4	4
Package in pcs 	240	120	120

* Custom production





ALUMINIUM W.15

MATT 3D EFFECT

DOWNPIPE [s=0,70]

W.15-WZR



Nominal dimension	80	100	100	120
Length in m	3,0	3,0	4,0	3,0
Price in €/m	With VAT	With VAT	With VAT	With VAT
ANM 1 Anthracite RAL 7016	9,30	9,96	9,96	13,44
	094131	094148	094155	094162
TMM 2 Testa di Moro RAL 8028	9,30	9,96	9,96	13,44
	100177	100184	100191	100207
SSM 3 Mouse grey RAL 7005	9,30	9,96	9,96	13,44
	100139	100146	100153	100160
ICM 4 Intense black RAL 9005	9,30	9,96	9,96	13,44
	115294	115300	115317	115324
OCM 5 Steel red RAL 3009	9,30	9,96	9,96	13,44
	115331	115348	115355	115362
ZHM 6 Brown grey RAL 7013	9,30	9,96	9,96	13,44
	112088	112095	112101 *	112118
BHM 7 White aluminum RAL 9006	9,30	9,96	9,96	13,44
	115249	115256	115263	115287
BM 8 Pure white RAL 9010	9,30	9,96	9,96	13,44
	132598	132604	132611	132628 *
ZSM 9 Zinc grey RAL extra	9,30	9,96	9,96	13,44
	132680 *	132727 *	132734 *	132789 *
MHM 10 Copper brown RAL 8004	9,30	9,96	9,96	13,44
	132673 *	132703 *	132758 *	132765 *
MZM 11 Moss green RAL 6005	9,30	9,96	9,96	13,44
	132697 *	132710 *	132741 *	132772 *
BHTM 12 Grey aluminum RAL 9007	9,30	9,96	9,96	13,44
	132635 *	132642 *	132659 *	132666 *
Package in m 	18	18	24	18
Package in m 	216	180	240	144



* Custom production

ALUMINIUM
W.15



PLASTIC DOWNPIPE SLEEVE

SD-ZR FOLIA KJG



Nominal dimension	Length in m	EAN product number	Packaging in m		Price with VAT [€/m]
					
60-150	100,0	139726	100	6 000	0,46

ALUMINIUM W.15

MATT 3D EFFECT

DOUBLE ELBOW

W.15-WKO

Nominal dimension	80	100	120
Price in €/pcs	With VAT	With VAT	With VAT
ANM 1 Anthracite RAL 7016	13,74 093813	16,80 093820	19,92 093837
TMM 2 Testa di Moro RAL 8028	13,74 099389 *	16,80 099402 *	19,92 099426 *
SSM 3 Mouse grey RAL 7005	13,74 099372	16,80 099396	19,92 099419 *
ICM 4 Intense black RAL 9005	13,74 118639 *	16,80 118646	19,92 118653 *
OCM 5 Steel red RAL 3009	13,74 118660 *	16,80 118677 *	19,92 118684 *
ZHM 6 Brown grey RAL 7013	13,74 111784 *	16,80 111791 *	19,92 111807 *
BHM 7 White aluminum RAL 9006	13,74 118608 *	16,80 118615 *	19,92 118622 *
BM 8 Pure white RAL 9010	13,74 136213 *	16,80 136220	19,92 136237 *
ZSM 9 Zinc grey RAL extra	13,74 136152 *	16,80 136169 *	19,92 136176 *
MHM 10 Copper brown RAL 8004	13,74 136091 *	16,80 136107	19,92 136114 *
MZM 11 Moss green RAL 6005	13,74 136121 *	16,80 136138 *	19,92 136145 *
BHTM 12 Grey aluminum RAL 9007	13,74 136183 *	16,80 136190 *	19,92 136206 *
Package in pcs 	4	4	2
Package in pcs 	240	120	120

* Custom production



ALUMINIUM
W.15



ALUMINIUM W.15

MATT 3D EFFECT

DOWNPIPE BRANCH 72°

W.15-WZO



Nominal dimension	80/80	100/80	100/100
Price in €/pcs	With VAT	With VAT	With VAT
ANM 1 Anthracite RAL 7016	48,00 094070 *	49,32 094087 *	49,80 094094
TMM 2 Testa di Moro RAL 8028	48,00 100412 *	49,32 100429 *	49,80 100436 *
SSM 3 Mouse grey RAL 7005	48,00 100351 *	49,32 100368 *	49,80 100375 *
ICM 4 Intense black RAL 9005	48,00 119018 *	49,32 119049 *	49,80 119087 *
OCM 5 Steel red RAL 3009	48,00 119025 *	49,32 119063 *	49,80 119094 *
ZHM 6 Brown grey RAL 7013	48,00 112026 *	49,32 112033 *	49,80 112040 *
BHM 7 White aluminum RAL 9006	48,00 119032 *	49,32 119056 *	49,80 119070 *
BM 8 Pure white RAL 9010	48,00 137258 *	49,32 157265 *	49,80 137272 *
ZSM 9 Zinc grey RAL extra	48,00 137432 *	49,32 137449 *	49,80 137456 *
MHM 10 Copper brown RAL 8004	48,00 137319 *	49,32 137326 *	49,80 137333 *
MZM 11 Moss green RAL 6005	48,00 137371 *	49,32 137388 *	49,80 137395 *
BHTM 12 Grey aluminum RAL 9007	48,00 137197 *	49,32 137203 *	49,80 137210 *
Package in pcs 	4	4	4
Package in pcs 	120	120	120

* Custom production

ALUMINIUM W.15

MATT 3D EFFECT

DOWNPIPE BRANCH 72°

W.15-WZO

Nominal dimension	120/80	120/100	120/120
Price in €/pcs	With VAT	With VAT	With VAT
ANM 1 Anthracite RAL 7016	53,76 094100 *	54,36 094117 *	54,72 094124 *
TMM 2 Testa di Moro RAL 8028	53,76 100443 *	54,36 100450 *	54,72 100467 *
SSM 3 Mouse grey RAL 7005	53,76 100382 *	54,36 100399 *	54,72 100405 *
ICM 4 Intense black RAL 9005	53,76 119117 *	54,36 119148 *	54,72 119179 *
OCM 5 Steel red RAL 3009	53,76 119100 *	54,36 119155 *	54,72 119186 *
ZHM 6 Brown grey RAL 7013	53,76 112057 *	54,36 112064 *	54,72 112071 *
BHM 7 White aluminum RAL 9006	53,76 119124 *	54,36 119131 *	54,72 119162 *
BM 8 Pure white RAL 9010	53,76 137289 *	54,36 137296 *	54,72 137302 *
ZSM 9 Zinc grey RAL extra	53,76 137463 *	54,36 137470 *	54,72 137487 *
MHM 10 Copper brown RAL 8004	53,76 137340 *	54,36 137357 *	54,72 137364 *
MZM 11 Moss green RAL 6005	53,76 137401 *	54,36 137418 *	54,72 137425 *
BHTM 12 Grey aluminum RAL 9007	53,76 137227 *	54,36 137234 *	54,72 137241 *
Package in pcs	3	3	3
Package in pcs	90	90	90

* Custom production





ALUMINIUM
W.15

ALUMINIUM W.15

MATT 3D EFFECT

PIPE BRACKET WITH THREAD M10

W.15-WOB

Nominal dimension	80	100	120
Price in €/pcs	With VAT	With VAT	With VAT
ANM 1 Anthracite RAL 7016	4,08 093875	4,26 093882	4,86 093899
TMM 2 Testa di Moro RAL 8028	4,08 099761	4,26 099778	4,86 099785
SSM 3 Mouse grey RAL 7005	4,08 099730	4,26 099747	4,86 099754
ICM 4 Intense black RAL 9005	4,08 118530	4,26 118547	4,86 118554 *
OCM 5 Steel red RAL 3009	4,08 118561 *	4,26 118578 *	4,86 118585 *
ZHM 6 Brown grey RAL 7013	4,08 111845	4,26 111852	4,86 111869
BHM 7 White aluminum RAL 9006	4,08 118509 *	4,26 118516 *	4,86 118523 *
BM 8 Pure white RAL 9010	4,08 136572 *	4,26 136589	4,86 136596 *
ZSM 9 Zinc grey RAL extra	4,08 136664 *	4,26 136671 *	4,86 136688 *
MHM 10 Copper brown RAL 8004	4,08 136602	4,26 136619	4,86 136626
MZM 11 Moss green RAL 6005	4,08 136633 *	4,26 136640 *	4,86 136657 *
BHTM 12 Grey aluminum RAL 9007	4,08 136541 *	4,26 136558 *	4,86 136565 *
Package in pcs 	10	10	10
Package in pcs 	1 200	1 200	1 200



* Custom production





ALUMINIUM W.15

MATT 3D EFFECT

STAINLESS STEEL SCREW FOR DOWNPIPE BRACKET M8x30 P-POB-NSK





Nominal dimension	EAN product number	Packaging in pcs		Price with VAT [€/pcs]
				
M8 x 30 *	139658	1	–	0,30

* Custom production

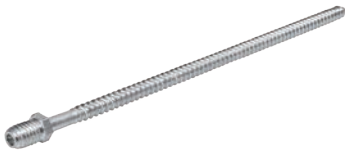
SCREW FOR DOWNPIPE BRACKET WITH THREADED TORX M10 P-POB-HT





ALUMINIUM W.15

Nominal dimension	EAN product number	Packaging in pcs		Price with VAT [€/pcs]
				
80	002464	100	40 000	1,20
140	002471	100	28 000	1,50
200	002488	100	20 000	1,86
250	002495	100	16 000	2,04
300	002501	100	11 200	2,04

DOWEL M10

P-POB-HN DB





Nominal dimension	EAN product number	Packaging in pcs		Price with VAT [€/pcs]
				
120	002426	100	25 000	0,48

DOWEL WITH LAMELLA M10

P-POB-HN DB





Nominal dimension	EAN product number	Packaging in pcs		Price with VAT [€/pcs]
				
180	002433	100	12 000	0,50
240	002440	100	12 000	0,60
280	002457	100	12 000	0,64

COMBISCREW TORX M10

P-POB-ZT/SZ



Nominal dimension	EAN product number	Packaging in pcs		Price with VAT [€/pcs]
				
140	002587	50	10 400	0,54
180	002594	50	10 400	0,66



ALUMINIUM W.15

MATT 3D EFFECT

INSULATION DOWEL M10

P-POB-HN IZOL





Nominal dimension	EAN product number	Packaging in pcs		Price with VAT [€/pcs]
				
M10 x 96	001207	25	2 625	3,24

INSULATING DOWEL TIP OF THE BRICK WITHOUT INSULATION

P-POB-HN WDVS140 M10





Nominal dimension	EAN product number	Packaging in pcs		Price with VAT [€/pcs]
				
140	144843	1/5	750	5,76

INSULATING DOWEL TIP OF THE BRICK WITH INSULATION

P-POB-HN WDVS300 M10





Nominal dimension	EAN product number	Packaging in pcs		Price with VAT [€/pcs]
				
300	144850	1/5	500	9,36

STAINLESS STEEL UNI PLATFORM TO ATTACH OB M10

P-POB-HN PLAT M10



Nominal dimension	EAN product number	Packaging in pcs		Price with VAT [€/pcs]
				
M10	144836	25/500	5 000	4,02



ALUMINIUM W.15

MATT 3D EFFECT

THREADED ROD M10

P-POB-ZT





Nominal dimension	EAN product number	Packaging in pcs		Price with VAT [€/pcs]
				
60	002556	100	20 800	0,24
100	002563	100	15 600	0,36
150	002570	50	10 400	0,66

DOWNPIPE BRACKET MOUNTING PLATE M10

P-POB-ZT MP

















Nominal dimension	EAN product number	Packaging in pcs		Price with VAT [€/pcs]
				
80 x 30	002518	25	5 200	1,38

RUBBER CAP FOR DOWNPIPE BRACKET SCREW

P-POB-HT AKG



Nominal dimension	EAN product number	Packaging in pcs		Price with VAT [€/pcs]
				
 29 x 13	002280	50	16 800	0,30
 29 x 13	002211	50	16 800	0,30
 29 x 13	002235	50	16 800	0,30
 29 x 13	002266	50	16 800	0,30
 29 x 13	002242	50	16 800	0,30
  29 x 13	002228	50	16 800	0,30
   29 x 13	002273	50	16 800	0,30
 29 x 13	002259	50	16 800	0,30
 29 x 13	002297	50	16 800	0,30

ALUMINIUM W.15

MATT 3D EFFECT

DOWNPIPE FLAP WITH SIEVE

W.15-WZVS



Nominal dimension	80	100	120
Price in €/pcs	With VAT	With VAT	With VAT
ANM 1 Anthracite RAL 7016	31,80 094216	34,92 094223	52,44 094230
TMM 2 Testa di Moro RAL 8028	31,80 100320	34,92 100337	52,44 100344
SSM 3 Mouse grey RAL 7005	31,80 100290	34,92 100306	52,44 100313
ICM 4 Intense black RAL 9005	31,80 114419	34,92 114426	52,44 114433
OCM 5 Steel red RAL 3009	31,80 114389 *	34,92 114402 *	52,44 114396 *
ZHM 6 Brown grey RAL 7013	31,80 112156	34,92 112163	52,44 112170
BHM 7 White aluminum RAL 9006	31,80 114440	34,92 114457	52,44 114464
BM 8 Pure white RAL 9010	31,80 124883 *	34,92 124890	52,44 124906 *
ZSM 9 Zinc grey RAL extra	31,80 124975 *	34,92 124982 *	52,44 124999 *
MHM 10 Copper brown RAL 8004	31,80 124913 *	34,92 124920 *	52,44 124937 *
MZM 11 Moss green RAL 6005	31,80 124944 *	34,92 124951 *	52,44 124968 *
BHTM 12 Grey aluminum RAL 9007	31,80 124852 *	34,92 124869 *	52,44 124876 *
Package in pcs 📦	2	3	3
Package in pcs 🛒	240	90	90

* Custom production

ALUMINIUM W.15

MATT 3D EFFECT

WATER COLLECTOR+HOSE

W.15-WZVHA

Nominal dimension	80	120
Price in €/pcs	With VAT	With VAT
ANM 1 Anthracite RAL 7016	78,00 094186 *	150,00 094209 *
TMM 2 Testa di Moro RAL 8028	78,00 100269 *	150,00 100283 *
SSM 3 Mouse grey RAL 7005	78,00 100238 *	150,00 100252 *
ICM 4 Intense black RAL 9005	78,00 116116 *	150,00 116130 *
OCM 5 Steel red RAL 3009	78,00 116147 *	150,00 116161 *
ZHM 6 Brown grey RAL 7013	78,00 112132 *	150,00 112149 *
BHM 7 White aluminum RAL 9006	78,00 116086 *	150,00 116109 *
BM 8 Pure white RAL 9010	78,00 137623 *	150,00 137647 *
ZSM 9 Zinc grey RAL extra	78,00 137715 *	150,00 137739 *
MHM 10 Copper brown RAL 8004	78,00 137654 *	150,00 137678 *
MZM 11 Moss green RAL 6005	78,00 137685 *	150,00 137708 *
BHTM 12 Grey aluminum RAL 9007	78,00 137593 *	150,00 137616 *
Package in pcs	1	1
Package in pcs	60	60

* Custom production



ALUMINIUM
W.15



ALUMINIUM W.15

MATT 3D EFFECT

WATER COLLECTOR WITH HOSE AND KNOB

W.15-WZVHAG





Nominal dimension	100	
Price in €/pcs	With VAT	
ANM 1 Anthracite RAL 7016	72,00	094193
TMM 2 Testa di Moro RAL 8028	72,00	100276 *
SSM 3 Mouse grey RAL 7005	72,00	100245 *
ICM 4 Intense black RAL 9005	72,00	116123 *
OCM 5 Steel red RAL 3009	72,00	116154 *
ZHM 6 Brown grey RAL 7013	72,00	112316 *
BHM 7 White aluminum RAL 9006	72,00	116093 *
BM 8 Pure white RAL 9010	72,00	137630 *
ZSM 9 Zinc grey RAL extra	72,00	137722 *
MHM 10 Copper brown RAL 8004	72,00	137661 *
MZM 11 Moss green RAL 6005	72,00	137692 *
BHTM 12 Grey aluminum RAL 9007	72,00	137609 *
Package in pcs 	1	
Package in pcs 	60	

* Custom production

ALUMINIUM W.15

MATT 3D EFFECT

GALVANIZED STEEL PREPAINTED PROTEC.GUTTER PIPE COL. W.15-WOZR

Nominal dimension	80	100	100
Length in m	1,0	1,0	1,5
Price in €/pcs	With VAT	With VAT	With VAT
ANM 1 Anthracite RAL 7016	78,60	61,20	124,80
	122742 *	122759 *	122766 *
TMM 2 Testa di Moro RAL 8028	78,60	61,20	124,80
	123046 *	123053 *	123060 *
SSM 3 Mouse grey RAL 7005	78,60	61,20	124,80
	122995 *	123008 *	123015 *
ICM 4 Intense black RAL 9005	78,60	61,20	124,80
	122797 *	122803 *	122810 *
OCM 5 Steel red RAL 3009	78,60	61,20	124,80
	122841 *	122858 *	122865 *
ZHM 6 Brown grey RAL 7013	78,60	61,20	124,80
	122940 *	122957 *	122964 *
BHM 7 White aluminum RAL 9006	78,60	61,20	124,80
	122896 *	122902 *	122919 *
BM 8 Pure white RAL 9010	78,60	61,20	124,80
	123190 *	123206 *	123213 *
ZSM 9 Zinc grey RAL extra	78,60	61,20	124,80
	123145 *	123152 *	123169 *
MHM 10 Copper brown RAL 8004	78,60	61,20	124,80
	123244 *	123251 *	123268 *
MZM 11 Moss green RAL 6005	78,60	61,20	124,80
	123091 *	123107 *	123114 *
BHTM 12 Grey aluminum RAL 9007	78,60	61,20	124,80
	123336 *	123305 *	123312 *
Package in pcs 	1	1	1
Package in pcs 	70	60	60

* Custom production





ALUMINIUM W.15

MATT 3D EFFECT

GALVANIZED STEEL PREPAINTED PROTEC.GUTTER PIPE COL. W.15-WOZR





Nominal dimension	120	120
Length in m	1,0	1,5
Price in €/pcs	With VAT	With VAT
ANM Anthracite RAL 7016	137,28	195,96
	122773 *	122780 *
TMM Testa di Moro RAL 8028	137,28	195,96
	123077 *	123084 *
SSM Mouse grey RAL 7005	137,28	195,96
	123022 *	123039 *
ICM Intense black RAL 9005	137,28	195,96
	122827 *	122834 *
OCM Steel red RAL 3009	137,28	195,96
	122872 *	122889 *
ZHM Brown grey RAL 7013	137,28	195,96
	122971 *	122988 *
BHM White aluminum RAL 9006	137,28	195,96
	122926 *	122933 *
BM Pure white RAL 9010	137,28	195,96
	123220 *	123237 *
ZSM Zinc grey RAL extra	137,28	195,96
	123176 *	123183 *
MHM Copper brown RAL 8004	137,28	195,96
	123275 *	123282 *
MZM Moss green RAL 6005	137,28	195,96
	123121 *	123138 *
BHTM Grey aluminum RAL 9007	137,28	195,96
	123329 *	123299 *
Package in pcs 	1	1
Package in pcs 	40	40

* Custom production

PIPE CLAMP WITH GASKET M10

P-POB-OZR



Nominal dimension	EAN product number	Packaging in pcs		Price with VAT [€/pcs]
				
80	002525	25	1 250	1,86
100	002532	25	1 250	2,40
120	002549	20	1 000	2,70

ALUMINIUM W.15

MATT 3D EFFECT

ALUMINIUM
W.15

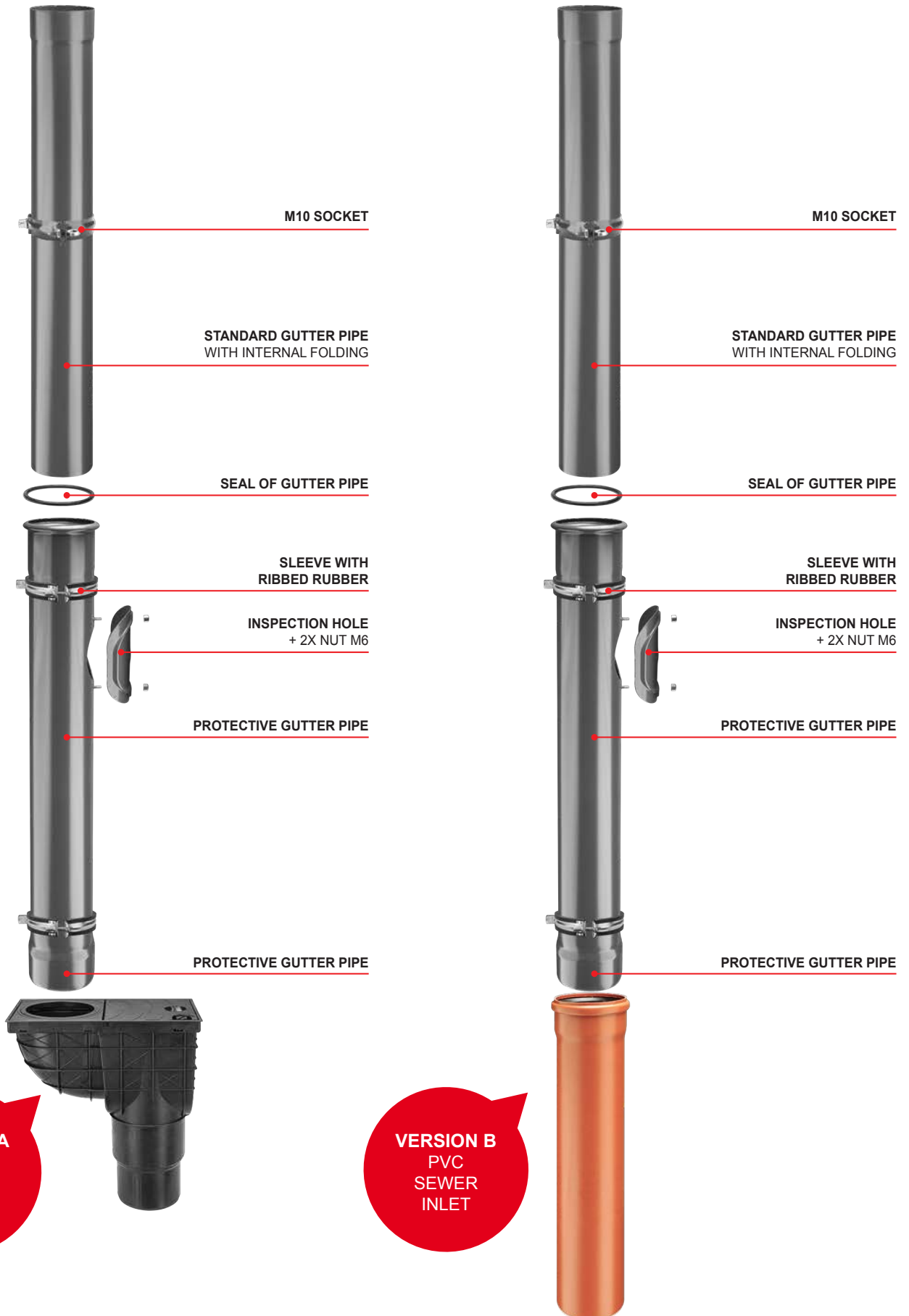

I. BASIC PROVISIONS

- 1.1. The company KJG a.s., with its registered office at Malinovského 800/131, 916 21 Čachtice, Company ID: 31 439 951 (hereinafter referred to as the „Seller“), issues the following General business terms and conditions that apply to the sale and supply of gutter roof system with accessories, light roofing, trapezoids, metallurgical materials, roofing accessories, tools, machinery and commercial goods related to the roof system (hereinafter referred to as the „goods“) performed by the Seller on the basis of a framework purchase contract (referred to as „FPC“) in relation to an entrepreneur in carrying out its business activities and to the state, state organization, self-governing territorial unit or to a legal entity established by law as a public institution in the provision of public needs or its own operation (hereinafter referred to as the „Buyer“).
- 1.2. These General terms and conditions as an integrated part of FPC are an integral part of each individual purchase contract (hereinafter also „IPC“ or „contract“) concluded between the Seller and the Buyer on the basis of FPC.

II. CONCLUSION OF PURCHASE CONTRACT

- 2.1. The Buyer's written order is considered to be a proposal to conclude an IPC, whereby each Buyer's order should contain:
 - identification data of the Buyer necessary for issuing the invoice,
 - specification of the ordered goods (especially type, kind, quantity and dimensions),
 - delivery place, delivery time and method of delivery of goods,
 - date of issue of the order,
 - name, surname, position and signature of the person authorized to act on behalf of the Buyer.
- 2.3. The IPC is considered closed at the moment of written confirmation of the Buyer's order by the Seller.

III. PURCHASE PRICE AND PAYMENT TERMS

- 3.1. The Buyer undertakes to pay the Seller the purchase price for the ordered goods properly and in due time. The purchase price is determined according to the Seller's price list (prices of goods are to be understood without VAT) valid on the day of submitting the order by the Buyer and its amount will be stated by the Seller in the Buyer's order confirmation including VAT (when delivering goods in Slovakia) according to valid legal regulations. In necessary cases, if the purchase price is determined on the basis of individual price calculation based on the valid price list, the Buyer shall be obliged to pay the purchase price up to the amount determined by price calculation on condition that the Seller shall determine the final purchase price according to costs incurred, but this shall not exceed the purchase price determined by calculation. The buyer is entitled to a discount on the price of the goods in the amount resulting from the FPC; if the Seller changes the amount of the Buyer's discount on the price of the goods during the FPC period, it shall immediately inform the Buyer in writing. When delivering the goods in the Slovak Republic, the Seller charges the Buyer, in addition to the price of the goods, VAT in accordance with the valid legal regulations.
- 3.2. The Buyer shall have a set financial credit limit for the purchase of goods and the maturity of invoices in accordance with the FPC, while the Seller shall be entitled to invoice the purchase price to the Buyer on the day of delivery or shipping the goods to the Buyer, respectively. After overdrawing the credit limit specified in the FPC or in the case of non-payment of the invoice by the Buyer within the due date, the Seller is entitled to interrupt the delivery of goods to the Buyer on the basis of the contract and not to confirm another written order of the Buyer. The Seller shall continue with further deliveries of goods:
 - in the case of exceeded credit limit - after payment of the oldest invoices up to the amount of exceeding the credit limit and simultaneous payment of the value of the required purchase of goods,
 - in the case of non-payment of the invoice within the due date - after its full payment. The Seller shall be entitled to change the credit limit set for the Buyer at any time throughout the duration of the FPC.
- 3.3. Payment shall be deemed to have been made in time if it has been credited to the Seller's account or paid in cash at the Seller's cash desk by the due date.
- 3.4. If the Buyer does not pay the invoice within the due date, the Seller shall be entitled to charge the Buyer for interest on late payment in the amount of 0.05 % of the unpaid amount for each day of delay.

IV. DELIVERY OF GOODS AND RETENTION OF TITLE

- 4.1. The Seller shall be obliged to deliver the goods to the Buyer in the quantity agreed in the contract and in a quality and design that is suitable for the purpose for which the goods are used. The Buyer is obliged to take over the goods delivered by the Seller.
- 4.2. Unless the contracting parties have agreed otherwise, the Seller is obliged to pack or arrange the goods for transport in the manner that is usual for such goods in business.
- 4.3. Delivery of the goods shall take place within the period and in the manner agreed by the contracting parties in the contract.
- 4.4. Upon delivery of the goods by the Seller, the Buyer's employee shall be obliged to prove the right to take over the goods.
- 4.5. If the goods are to be made available not loaded on a means of transport at the Seller's registered office (or the relevant warehouse of the Seller, to which the Buyer has submitted an order) by the Buyer to the designated carrier, the latter is obliged to prove the right to take over the goods.
- 4.6. In the event that the goods are to be delivered to the Buyer to the delivery point specified in the order using a Seller's vehicle, the Seller will charge the Buyer for transport costs according to the transport price list valid on the day of submitting the order by the Buyer. At the same time, the Seller reserves the right to unload the goods only in an available terrain at its sole discretion.
- 4.7. In the case of goods to be sent to the Buyer, the Seller shall charge the Buyer for postage, unless agreed otherwise.
- 4.8. The Buyer undertakes to withdraw the goods within the delivery period. If the Buyer fails to fulfil its obligation to take over the goods within the delivery period, the Seller shall invite the Buyer to fulfil the Seller's obligation within an additional reasonable period. Failure to take over the goods by the Buyer nor within an additional reasonable period gives rise to the Seller's right to withdraw from the contract.
- 4.9. The buyer who does not pay the whole amount of the purchase price until the delivery of the goods will acquire ownership of the delivered goods only after full payment of the purchase price.

V. PASSING OF RISK OF DAMAGE TO GOODS

- 5.1. The risk of damage to the goods passes to the Buyer at the moment the Buyer takes over the goods from the Seller, or by the carrier designated by him, or if the Buyer fails to do so in time, at the time when the Seller or the Seller's designated carrier allows the Buyer to dispose of the goods, while the Buyer is being aware of this possibility and breaches the contract by not taking over the goods.
- 5.2. If the Seller is to hand over the goods for transport by the carrier designated by the Buyer at its registered office in Čachtice (or the relevant warehouse of the Seller) from which the Buyer is to take over the goods, the risk of damage to the goods passes to the Buyer upon handing over the goods to this carrier.
- 5.3. In the event that the Seller is to send the goods to the Buyer, the risk of damage to the goods passes to the Buyer at the time of delivery of the goods to the first carrier for transport to the destination.
- 5.4. The buyer is obliged to inspect the goods without undue delay after the risk of damage to the goods has passed. If the goods are sent to the Buyer, the Buyer is obliged to inspect the goods without undue delay after their delivery to the destination. The company KJG a.s. reserves the right to change prices, packaging and printing.

VI. LIABILITY FOR DEFECTS AND WARRANTY

- 6.1. The Seller shall be responsible for the defect by which the goods have been affected at the moment when the risk of damage to the goods passes to the Buyer, even if the defect becomes apparent only after this time. The Seller is also responsible for any defect arising after the risk of damage to the goods has passed to the Buyer if caused by a breach of the Buyer's duties.
- 6.2. If the Buyer does not inspect the goods or does not arrange to inspect them at the time of passing the risk of damage to the goods, the Buyer may claim for defects detectable during this inspection only if the Buyer proves that the goods was already affected by these defects at the time of passing the risk of damage to the goods.
- 6.3. The Buyer shall be obliged to notify the Seller of defects in the goods without undue delay after:
 - a/ The Buyer found the defects,
 - b/ The Buyer, while exercising professional care, should have found defects during the inspection, which the Buyer is obliged to carry out after the risk of damage to the goods has passed, or
 - c/ The defects could be found later with the exercise of professional care, but no later than within two years from the time of delivery of the goods, or from the arrival of the goods to the destination specified in the contract. For defects covered by the quality warranty, instead of this period of time the warranty period applies.
- 6.4. If the Seller provides the Buyer with a warranty for the quality of the delivered goods, it shall do so by making a statement in a separate warranty card, which will also state the procedure for complaints.
- 6.5. The warranty period begins to run from the date of delivery of the goods. If the Seller is obliged to send the goods, the warranty period runs from the day the goods arrive at its destination. The warranty period does not run for a period during which the Buyer cannot use the goods due to their defects, which is the Seller's responsibility.
- 6.6. In the case of delivery of goods to the Buyer with defects, the use of prov. § 436, § 437, § 439 par. 2, 3, 4 and § 441 of the Commercial Code are explicitly excluded and the Seller in such a case shall provide the Buyer with a discount on the purchase price or shall remove the defects in the goods complained by the Buyer:
 - a/ by delivery of missing goods,
 - b/ by repair of goods or delivery of replacement goods in case of remediable defects
 - c/ by delivery of replacement goods in the event of irreparable defects.
- 6.7. The discount granted by the Seller on the purchase price shall correspond to the difference between the value of the goods without defects and the value of the goods delivered with defects, while the decisive time for determining the values is the time at which proper fulfillment should have taken place. The Buyer, to whom the Seller has been granted a discount on the purchase price, is not entitled to claim compensation for the loss of profit due to the lack of properties of the goods to which the discount applies.
- 6.8. Upon delivery of replacement goods, the Seller shall be entitled to demand the exchanged goods to be returned to the Seller at the Buyer's expense in the condition in which they were delivered to the Buyer. This does not apply if the impossibility of returning the goods in the condition specified therein is not caused by the actions or omissions of the Buyer, or if the change in the condition of the goods occurred as a result of an inspection duly performed to detect defects in the goods. In the event that before the detection of defects the Buyer sold the goods or part thereof or consumed the goods in whole or in part or altered them in their normal use, the Buyer shall be obliged to return unsold or unconsumed goods or altered goods and provide the Seller with compensation to the extent to which the Seller has benefited from that use of the goods.
- 6.9. The Seller's responsibility for defects not covered by the quality warranty does not arise if these defects were caused after the passing of the risk of damage to the goods by external events and were not caused by the Seller or the persons who helped to fulfil the Seller's obligation.

VII. VIS MAJOR

- 7.1. If, after the conclusion of the contract, unforeseeable and uncontrollable circumstances arise which create a permanent or temporary obstacle to the fulfillment of the obligations of the contracting parties of the concluded contract (refer to vis major), the non-fulfillment of obligations (in case of permanent obstacle) by a contracting party, or a delayed fulfillment of obligations (in case of temporary obstacle), shall not be considered a breach of this contract and the contracting party shall not be responsible for any damages that arise in connection with non-fulfillment of contractual obligations. If the obstacle incurred is only temporary for the fulfillment of obligations under the contract, the contracting parties undertake to start fulfilling their contractual obligations immediately after this obstacle disappears. Each contracting party shall be obliged to inform immediately the other contracting party of the occurrence of the above obstacles.
- 7.2. The followings are mainly considered to be vis major: natural events, arbitrary acts of third parties, strikes, work lockouts, blockades, wars (declared or undeclared), a change in the political situation or any other similar event which precludes or unduly impedes the exercise of rights and obligations under the contract.

VIII. PRIVACY POLICY

- 8.1. The Buyer (for the purposes of this article also another person signed on the FPC and the order on behalf of the Buyer) expressly grants to the Seller, according to Act no. 428/2002 Coll. on personal data protection as amended (hereinafter referred to as the „Act“), consent to the processing of its personal data specified in the FPC and the Buyer's order.
- 8.2. The Buyer expressly authorizes the Seller to process personal data for the purposes of:
 - a/ exercise of the rights and obligations arising from the FPC and IPC,
 - b/ keeping records, the obligation of which arises for the Seller by law or on the basis of the Act,
 - c/ performing marketing activities.
- 8.3. The Buyer expressly gives the Seller consent to provide the Buyer's personal data for the purposes stated in point 8.2 to a third party which has been entrusted by the Buyer with the activity in question.
- 8.4. The Buyer expressly grants the Seller consent to the processing of personal data:
 - a/ for the period in which the Seller is obliged to keep the records referred to in point 8.2. b /,
 - c/ for the period in which it is necessary to protect the legal rights and legally protected interests of the Seller.
- 8.5. The Buyer takes into account that it has the right to revoke its consent to the processing of personal data and require the liquidation of its personal data in the event that the Seller, or a third party to whom the Seller has provided personal data, respectively, breaches the obligations arising from the Act.

IX. FINAL PROVISIONS

- 9.1. The Buyer is not entitled to transfer or assign the rights resulting for the Buyer from the FPC or IPC to a third party without the express consent of the Seller.
- 9.2. The FPC may be amended, unless otherwise provided in these General Terms and Conditions, only in the form of written amendments signed by representatives of both the contracting parties.
- 9.3. The agreed deviating provisions in the IPC between the Seller and the Buyer take precedence over the provisions of the FPC and these General Terms and Conditions. Legal relations that are not regulated in the FPC, IPC or in these General Terms and Conditions are governed by the Commercial Code and other generally binding legal regulations in force in the Slovak Republic, excluding the use of conflicting rules of law and the application of the UN Convention on Contracts for the International Sale of Goods /CISG/ of April 11, 1980 and their possible amendments in the case the Buyer has its registered office (place of business) in another state or the goods are delivered to another state.
- 9.4. All disputes arising from the implementation of the content of the FPC will be resolved by the contracting parties through an amicable settlement. Disputes that cannot be resolved by mutual agreement are entitled to be resolved (exclusively) by the competent court in the Slovak Republic.
- 9.5. These General Terms and Conditions are issued by the Seller pursuant to § 273 of the Commercial Code, with effect from January 1, 2017.