



ERESZCSATORNA RENDSZER FÉLKÖRÍVES



ÁRLISTA

2024

AJÁNLOTT FOGYASZTÓ ÁRAK



POWERFUL PARTNER FOR YOUR ROOF



Alumínium anyag | 5



Csatorna | 7

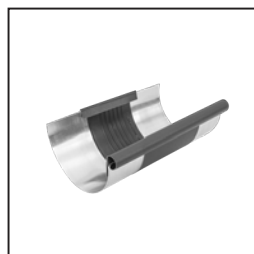

Dilatációs betét | 9



Csatorna tartozékok | 12



Csatornatartó | 14



Szeglet | 17



Véglemez | 19



Betorkollócsonk | 20



Könyök | 30

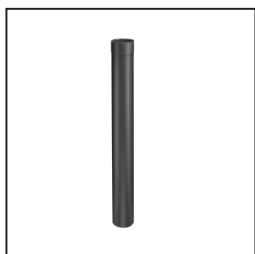

Lefolyócső | 33



Lefolyócső tartozékok | 35



Bilincsfej | 37

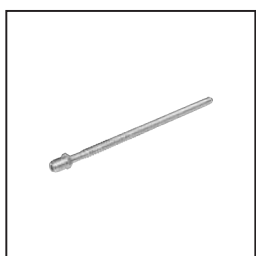

Bilincsfej tartozékok | 38



Esőlopó | 41



Állványcső | 44

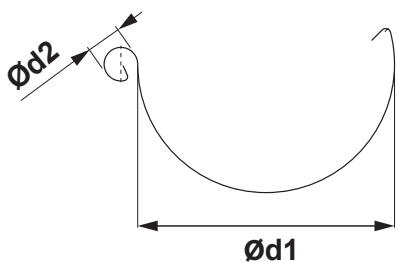

TETŐERESZ MÉRETEK

(méretek és méretbeli tűrések az EN 612 szerint)

| Kiterített szélesség (mm) | 250 | 280 | 333 |
|---------------------------|-----|-----|-----|
| Ød1 | 105 | 127 | 153 |
| Ød2 | 18 | 18 | 20 |

BELSŐ FALC

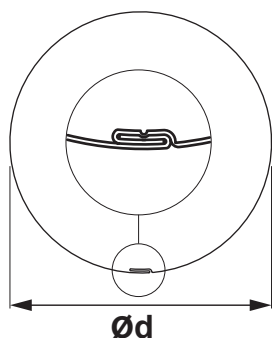

LEFOLYÓCSŐ MÉRETEK

(méretek és méretbeli tűrések az EN 612 szerint)

| Méretek | 80 | 100 | 120 |
|------------------------|----|-----|-----|
| Névleges méret Ød (mm) | 80 | 100 | 120 |

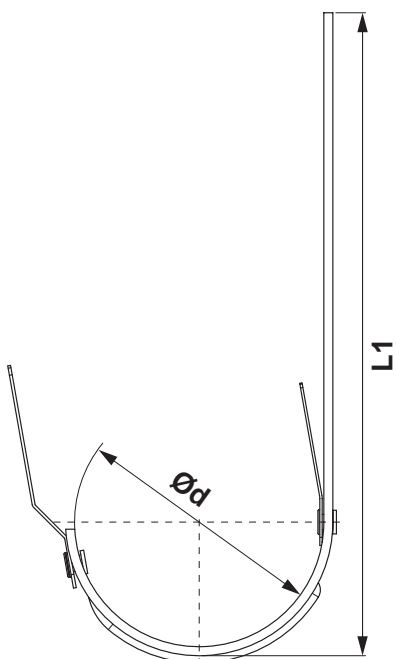

ERESZCSATORNA TARTÓ KAMPÓK MÉRETEI

(méretek és méretbeli tűrések az EN 612 szerint)

| Méretek (mm) | L1 | Ød |
|--------------|-----|-----|
| 250 | 310 | 105 |
| 280 | | 127 |
| 333 – 550 | 385 | 153 |

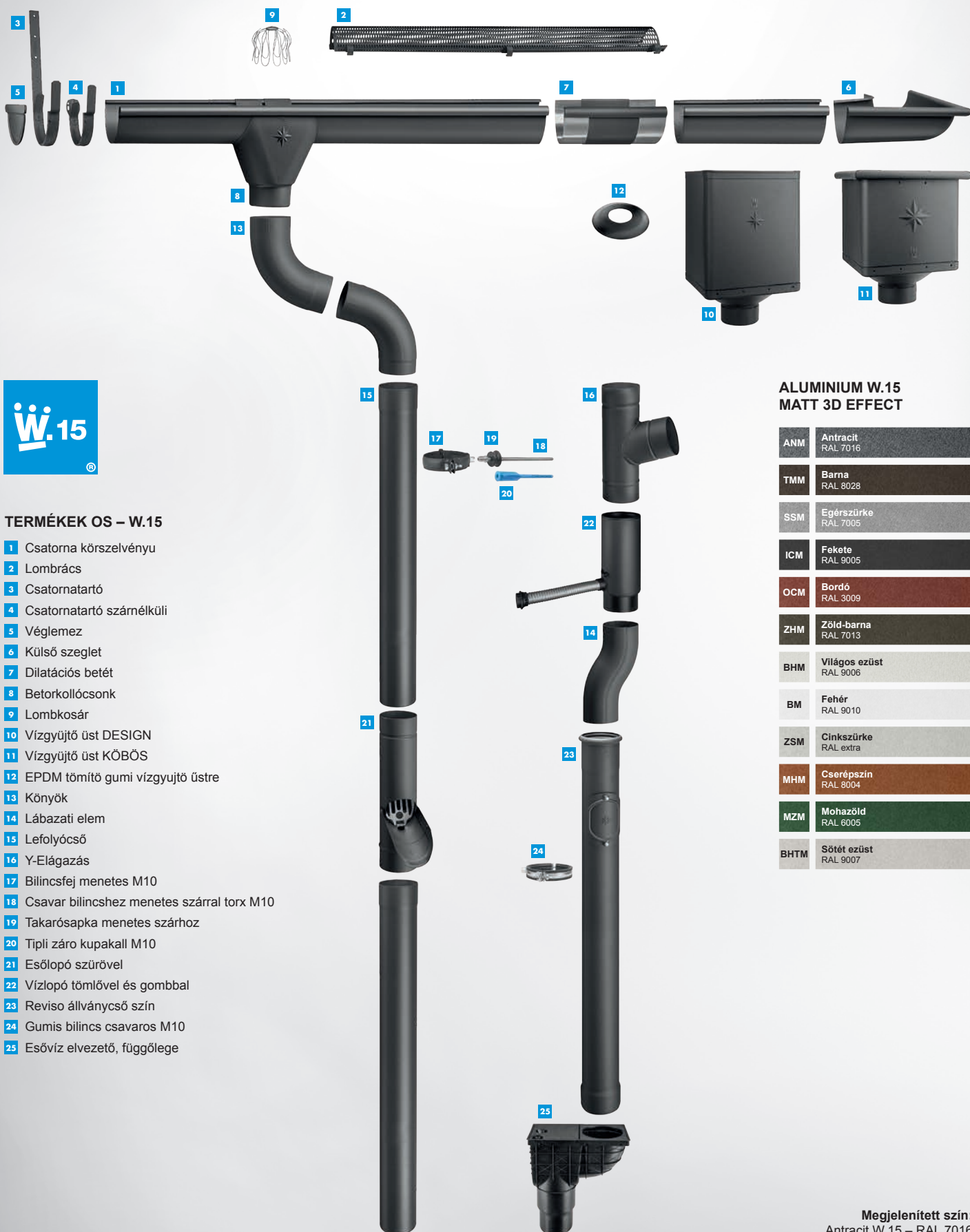

TERMÉKEK OS – W.15

- 1 Csatorna körszelvényu
- 2 Lombrács
- 3 Csatornatartó
- 4 Csatornatartó szárnélküli
- 5 Véglemez
- 6 Külső szeglet
- 7 Dilatációs betét
- 8 Betorkollócsonk
- 9 Lombkosár
- 10 Vízyűjtő üst DESIGN
- 11 Vízyűjtő üst KÖBÖS
- 12 EPDM tömítő gumi vízyűjtő üstre
- 13 Könyök
- 14 Lábazati elem
- 15 Lefolyócső
- 16 Y-Elágazás
- 17 Bilincsfaj menetes M10
- 18 Csavar bilincshez menetes szárral torx M10
- 19 Takarósapka menetes szárhoz
- 20 Típli záro kupakall M10
- 21 Esőlopó szűrővel
- 22 Vízlopó tömlővel és gombbal
- 23 Reviso állványcső szín
- 24 Gumis bilincs csavaros M10
- 25 Esővíz elvezető, függőlege

ALUMINIUM W.15 MATT 3D EFFECT

| | |
|------|---------------------------|
| ANM | Antracit RAL 7016 |
| TMM | Barna RAL 8028 |
| SSM | Egérszürke RAL 7005 |
| ICM | Fekete RAL 9005 |
| OCM | Bordó RAL 3009 |
| ZHM | Zöld-barna RAL 7013 |
| BHM | Világos ezüst RAL 9006 |
| BM | Fehér RAL 9010 |
| ZSM | Cinkszürke RAL extra |
| MHM | Cserépszín RAL 8004 |
| MZM | Mohazöld RAL 6005 |
| BHTM | Sötét ezüst RAL 9007 |





ALUMINIUM W.15 MATT 3D EFFECT

SPEIRA

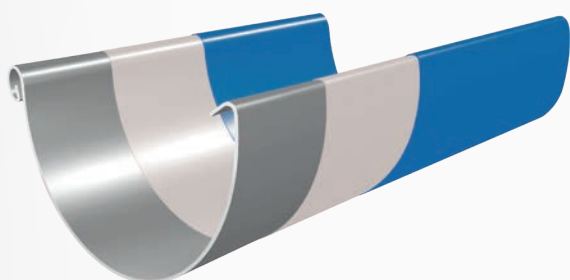
A Speira az alumínium hengerlés és újrahasznosítás terén egy globális vállalat. Németországban és Norvégiában található hét gyártóüzemből és egy kutató-fejlesztő központból áll, beleértve vegyesvállalatunkat - az Alunorf-ot, a világ legnagyobb alumínium hengerművét - a Grevenbroich-ot, a világ legnagyobb alumínium-megmunkáló üzemét, valamint számos nemzetközi értékesítési irodát. A Speira körülbelül 5000 embert foglalkoztat, főként Németországban és Norvégiában.



-  Felső lakkozott réteg (kb. 20 μm) poliuretán alapú a kiváló optikáért és a legnagyobb sérülésállóságért, MATT 3D hatás
-  Alapozó réteg (kb. 5 μm) a tökéletes tapadás és szilárd védelem érdekében
-  Optimalizált alumínium szalag az ereszcatorna rendszerhez OS – W.15

KJG

SPACE



ELEGÁNS MATT FELÜLETŰ ALUMÍNIUM ANYAG



W.15

Minőségi szín
Lótusz-effektussal

Karcolással szembeni
magas ellenálló-képesség

Magas
színkonzisztencia



W.15 – tizenkét
színváltozat

40 év jótállás
az anyagra és a színre



CSATORNA KÖRSZELVÉNYU [s=0,70]

W.15-WZ

| Névleges méret | 250 | 280 | 333 | 333 |
|--|----------|----------|----------|----------|
| Hossz m | 4,0 | 4,0 | 4,0 | 6,0 |
| Ár HUF/m | Áfával | Áfával | Áfával | Áfával |
| ANM Antracit RAL 7016 | 2 723,00 | 3 432,00 | 3 454,00 | 3 454,00 |
| | 094001 | 094018 | 094025 | 094032 |
| TMM Barna RAL 8028 | 2 723,00 | 3 432,00 | 3 454,00 | 3 454,00 |
| | 100030 | 100047 * | 100054 | 100061 |
| SSM Egérszürke RAL 7005 | 2 723,00 | 3 432,00 | 3 454,00 | 3 454,00 |
| | 099990 | 100009 | 100016 | 100023 |
| ICM Fekete RAL 9005 | 2 723,00 | 3 432,00 | 3 454,00 | 3 454,00 |
| | 114662 | 114679 | 114686 | 114693 |
| OCM Bordó RAL 3009 | 2 723,00 | 3 432,00 | 3 454,00 | 3 454,00 |
| | 114709 | 114716 * | 114723 * | 114730 |
| ZHM Zöld-barna RAL 7013 | 2 723,00 | 3 432,00 | 3 454,00 | 3 454,00 |
| | 111982 | 111999 | 112002 | 112019 |
| BHM Világos ezüst RAL 9006 | 2 723,00 | 3 432,00 | 3 454,00 | 3 454,00 |
| | 114624 | 114631 * | 114648 | 114655 |
| BM Fehér RAL 9010 | 2 723,00 | 3 432,00 | 3 454,00 | 3 454,00 |
| | 132833 * | 132888 * | 132932 | 132949 |
| ZSM Cinkszürke RAL extra | 2 723,00 | 3 432,00 | 3 454,00 | 3 454,00 |
| | 132796 * | 132840 * | 132895 * | 132987 * |
| MHM Cserépszín RAL 8004 | 2 723,00 | 3 432,00 | 3 454,00 | 3 454,00 |
| | 132819 * | 132864 * | 132918 * | 132963 * |
| MZM Mohazöld RAL 6005 | 2 723,00 | 3 432,00 | 3 454,00 | 3 454,00 |
| | 132802 * | 132857 * | 132901 * | 132970 * |
| BHTM Sötét ezüst RAL 9007 | 2 723,00 | 3 432,00 | 3 454,00 | 3 454,00 |
| | 132826 * | 132871 * | 132925 * | 132956 * |
| Csomagolás m  | 20 | 20 | 20 | 30 |
| Csomagolás m  | 960 | 840 | 660 | 990 |

* Gyártás rendelésre





ALUMINIUM W.15

MATT 3D EFFECT

FEKVÖERESZ [s=0,70]

W.15-WZS



| Névleges méret | 650 |
|--|-----------------------------|
| Hossz m | 6,0 |
| Ár HUF/m | Áfával |
| ANM 1 Antracit RAL 7016 | 8 900,00 094179 |
| TMM 2 Barna RAL 8028 | 8 900,00 100214 * |
| SSM 3 Egérszürke RAL 7005 | 8 900,00 100221 * |
| ICM 4 Fekete RAL 9005 | 8 900,00 114471 * |
| OCM 5 Bordó RAL 3009 | 8 900,00 114488 * |
| ZHM 6 Zöld-barna RAL 7013 | 8 900,00 112125 * |
| BHM 7 Világos ezüst RAL 9006 | 8 900,00 114495 * |
| BM 8 Fehér RAL 9010 | 8 900,00 137500 * |
| ZSM 9 Cinkszürke RAL extra | 8 900,00 137531 * |
| MHM 10 Cserépszín RAL 8004 | 8 900,00 137517 * |
| MZM 11 Mohazöld RAL 6005 | 8 900,00 137524 * |
| BHTM 12 Sötét ezüst RAL 9007 | 8 900,00 137494 * |
| Csomagolás m  | 6 |
| Csomagolás m  | 300 |

* Gyártás rendelésre



DILATÁCIÓS BETÉT

W.15-WZDI

| Névleges méret | 250/260 | 285/260 | 333/260 |
|---|-----------------------------|-----------------------------|-----------------------------|
| Ár HUF/db | Áfával | Áfával | Áfával |
| ANM 1 Antracit RAL 7016 | 9 432,00 093356 * | 9 897,00 093363 * | 9 897,00 093370 |
| TMM 2 Barna RAL 8028 | 9 432,00 098702 * | 9 897,00 098719 * | 9 897,00 098726 |
| SSM 3 Egérszürke RAL 7005 | 9 432,00 098818 * | 9 897,00 098825 * | 9 897,00 098832 * |
| ICM 4 Fekete RAL 9005 | 9 432,00 118738 * | 9 897,00 118745 * | 9 897,00 118752 |
| OCM 5 Bordó RAL 3009 | 9 432,00 118769 * | 9 897,00 118776 * | 9 897,00 118783 * |
| ZHM 6 Zöld-barna RAL 7013 | 9 432,00 111401 * | 9 897,00 111418 * | 9 897,00 111432 |
| BHM 7 Világos ezüst RAL 9006 | 9 432,00 118707 * | 9 897,00 118714 * | 9 897,00 118721 * |
| BM 8 Fehér RAL 9010 | 9 432,00 137029 * | 9 897,00 137036 * | 9 897,00 137043 * |
| ZSM 9 Cinkszürke RAL extra | 9 432,00 137111 * | 9 897,00 137128 * | 9 897,00 137135 * |
| MHM 10 Cserépszín RAL 8004 | 9 432,00 137050 * | 9 897,00 137067 * | 9 897,00 137074 * |
| MZM 11 Mohazöld RAL 6005 | 9 432,00 137081 * | 9 897,00 137098 * | 9 897,00 137104 * |
| BHTM 12 Sötét ezüst RAL 9007 | 9 432,00 136992 * | 9 897,00 137005 * | 9 897,00 137012 * |
| Csomagolás db  | 3 | 3 | 5 |
| Csomagolás db  | 360 | 360 | 200 |

* Gyártás rendelésre

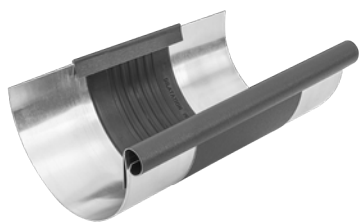



ALUMINIUM W.15

MATT 3D EFFECT

FEKVÖERESZ DILATÁCIO

W.15-WZSDI

| Névleges méret | 670/260 |
|---|------------------------------|
| Ár HUF/db | Áfával |
| ANM 1 Antracit RAL 7016 | 29 933,00 093400 * |
| TMM 2 Barna RAL 8028 | 29 933,00 098757 * |
| SSM 3 Egérszürke RAL 7005 | 29 933,00 098863 * |
| ICM 4 Fekete RAL 9005 | 29 933,00 118806 * |
| OCM 5 Bordó RAL 3009 | 29 933,00 118813 * |
| ZHM 6 Zöld-barna RAL 7013 | 29 933,00 111425 * |
| BHM 7 Világos ezüst RAL 9006 | 29 933,00 118790 * |
| BM 8 Fehér RAL 9010 | 29 933,00 137555 * |
| ZSM 9 Cinkszürke RAL extra | 29 933,00 137586 * |
| MHM 10 Cserépszín RAL 8004 | 29 933,00 137562 * |
| MZM 11 Mohazöld RAL 6005 | 29 933,00 137579 * |
| BHTM 12 Sötét ezüst RAL 9007 | 29 933,00 137548 * |
| Csomagolás db  | 1 |
| Csomagolás db  | 40 |

* Gyártás rendelésre



ALUMINIUM
W.15

A DILATÁCIÓS ERESZCSATORNA ÉS SZALAG HASZNÁLATA

DILATÁCIÓS ERESZCSATORNA

Szerelési példa: Függő, ereszcatorna 500 mm kiterített szélességig.
A dilatációs ereszcatornát 15 m-es közböben kell felszerelni. A külső szögletre és az ereszcatorna elejére elég a normál érték fele: legfeljebb 7,5 m. A belső szögletre a normál érték negyede felel meg: legfeljebb 3,75 m. Egyéb anyagokra és méretekre vonatkozóan: lásd az alábbi táblázatot. A szögletek mindig szilárd pontokként számítandók.

ETŐERESZEK FÉLKÖRÍVES DILATÁCIÓS ERESZCSATORNÁK

| Ereszcatorna kiterített szélessége | Alumínium | Acél, Titán-cink, Réz, Rozsdamentes acél |
|------------------------------------|-----------|--|
| < 500 | 12 | 15 |
| > 500 | 8 | 10 |

DILATÁCIÓS SZALAG

Belső beépítés: az alapra ragasztás nélkül rögzített ereszcatornák, nem szokványos profilú és lemezborítású falazattal ellátott tetők

TETŐERESZ DILATÁCIÓS SZALAG

| Ereszcatorna kiterített szélessége | Alumínium | Acél, Titán-cink, Réz, Rozsdamentes acél |
|------------------------------------|-----------|--|
| < 500 | 8 | 10 |
| > 500 | 6 | 8 |

A külső szögletre vagy az ereszcatorna elejére elég a normál érték fele. A belső szögletre a normál érték egynegyede érvényes.

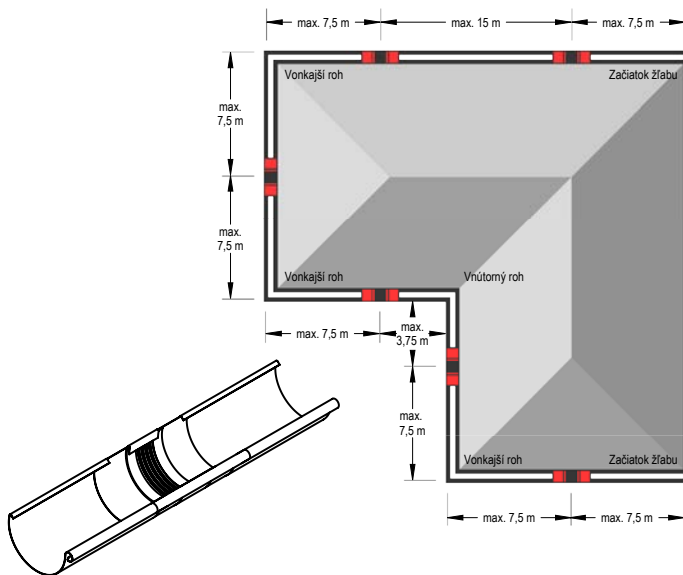

Megjegyzés a dilatációs ereszcatorna szereléséhez.

A forrasztás segítségével végzett szerelésnél először a középső gumi alkatrészt kell vizes ronggyal letakarni (hogy a meleg ne terjedjen át a középső gumi alkatrészbe). Be kell tartani a középső gumi alkatrésztől mért 6 cm legkisebb távolságot. Minden esetben kerülni kell a gumi nyílt lánggal való érintkezését.

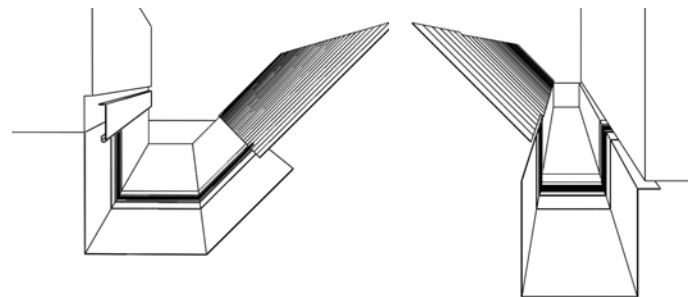

Megjegyzés a dilatációs szalag alkalmazásához.

A dilatációs szalag hajlításánál, szerelésénél győződjön meg arról, hogy:



- A hajlító-pofák rádiusza legalább 2 mm.
- A bádoglemez 1 mm vastagságától be kell tartani a hajlítási sugár 5 mm-es legkisebb értékét.
- A hajlító pofákat a hajlítás során a nyíróhatás - a gumi megrongálásának a megelőzése - céljából a középső gumi alkatrész 3 - 4 mm-es vastagságára kell beállítani.
- A középső gumi elem a hajlítás során nem lehet összenyomva, vagy megrongálva. Ezért egy 2-5 mm (vastag), úgy meghajlított alumínium bádoglemezt kellene alkalmazni, hogy az a hajlító pofák védőelemeként lehessen rögzítve. Így nagyobb hajlítási sugár érhető el megakadályozva a középső gumirész sérülését.

ALUMINIUM W.15

MATT 3D EFFECT

LOMBRÁCS

W.15-WZNLM

| | | |
|---|----|------------------------------|
| Névleges méret | | 333 |
| Hossz m | | 2,0 |
| Ár HUF/db | | Áfával |
| ANM Antracit RAL 7016 | 1 | 11 956,00 097149 * |
| TMM Barna RAL 8028 | 2 | 11 956,00 118035 * |
| SSM Egérszürke RAL 7005 | 3 | 11 956,00 118028 * |
| ICM Fekete RAL 9005 | 4 | 11 956,00 118004 * |
| OCM Bordó RAL 3009 | 5 | 11 956,00 118011 * |
| ZHM Zöld-barna RAL 7013 | 6 | 11 956,00 118042 * |
| BHM Világos ezüst RAL 9006 | 7 | 11 956,00 117991 * |
| BM Fehér RAL 9010 | 8 | 11 956,00 137142 * |
| ZSM Cinkszürke RAL extra | 9 | 11 956,00 137173 * |
| MHM Cserépszín RAL 8004 | 10 | 11 956,00 137159 * |
| MZM Mohazöld RAL 6005 | 11 | 11 956,00 137166 * |
| BHTM Sötét ezüst RAL 9007 | 12 | 11 956,00 137180 * |
| Csomagolás db  | | 15 |
| Csomagolás db  | | 120 |

* Gyártás rendelésre

ALUMINIUM
W.15

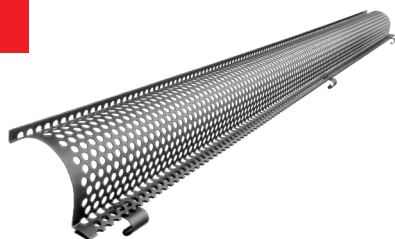

ALUMINIUM W.15

MATT 3D EFFECT

PVC LOMBRÁCS

SD-ZNL MREZKA

| Névleges méret | Hossz m | EAN szám | Csomagolás db | | Ár áfával [HUF/db] |
|----------------|---------|----------|---------------|-----|--------------------|
| | | | | | |
| PS 171 | 1,0 | 008473 | 30 | 450 | 1 990,00 |
| TM 171 | 1,0 | 008466 | 30 | 450 | 1 990,00 |

PVC LOMBRÁCS

SD-ZNL N

| Névleges méret | Hossz m | EAN szám | Csomagolás db | | Ár áfával [HUF/db] |
|----------------|---------|----------|---------------|-----|--------------------|
| | | | | | |
| 250 | 3,0 | 008480 | 10 | 400 | 10 580,00 |
| 280-333 | 3,0 | 008497 | 10 | 400 | 10 630,00 |

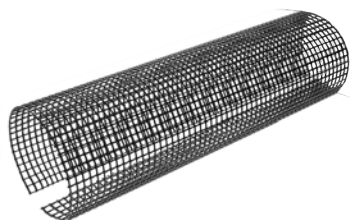
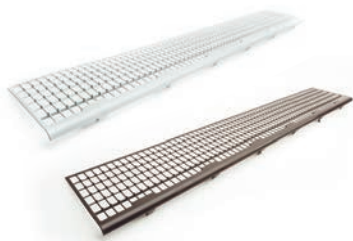



ALUMINIUM W.15

MATT 3D EFFECT

CSATORNATARTÓ RÉGI TÍPUS

W.15-WHP

| Névleges méret | 250/430 | 280/480 | 333/550 |
|---|-----------------------------|-----------------------------|-----------------------------|
| Anyag | 23/7 | 28/7 | 28/7 |
| Ár HUF/db | Áfával | Áfával | Áfával |
| ANM 1 Antracit RAL 7016 | 1 572,00 093455 | 1 793,00 093462 | 1 970,00 093479 |
| TMM 2 Barna RAL 8028 | 1 572,00 098986 | 1 793,00 098993 | 1 970,00 099006 |
| SSM 3 Egérszürke RAL 7005 | 1 572,00 098955 | 1 793,00 098962 | 1 970,00 098979 |
| ICM 4 Fekete RAL 9005 | 1 572,00 116475 | 1 793,00 116482 | 1 970,00 116499 |
| OCM 5 Bordó RAL 3009 | 1 572,00 116505 | 1 793,00 116512 * | 1 970,00 116529 |
| ZHM 6 Zöld-barna RAL 7013 | 1 572,00 111449 | 1 793,00 111456 | 1 970,00 111463 |
| BHM 7 Világos ezüst RAL 9006 | 1 572,00 116444 * | 1 793,00 116451 * | 1 970,00 116468 |
| BM 8 Fehér RAL 9010 | 1 572,00 133083 * | 1 793,00 133090 * | 1 970,00 133106 |
| ZSM 9 Cinkszürke RAL extra | 1 572,00 133175 * | 1 793,00 133182 * | 1 970,00 133199 * |
| MHM 10 Cserépszín RAL 8004 | 1 572,00 133113 | 1 793,00 133120 * | 1 970,00 133137 |
| MZM 11 Mohazöld RAL 6005 | 1 572,00 133144 * | 1 793,00 133151 * | 1 970,00 133168 * |
| BHTM 12 Sötét ezüst RAL 9007 | 1 572,00 133052 * | 1 793,00 133069 * | 1 970,00 133076 * |
| Csomagolás db  | 15 | 15 | 15 |
| Csomagolás db  | 600 | 600 | 600 |

* Gyártás rendelésre



ALUMINIUM
W.15



ALUMINIUM W.15

MATT 3D EFFECT

CSATORNATARTÓ SZÁRNÉLKÜLI

W.15-WHPK



| Névleges méret | 250 | 280 | 333 |
|---|----------|----------|----------|
| Anyag | 28/7 | 28/7 | 28/7 |
| Ár HUF/db | Áfával | Áfával | Áfával |
| ANM 1 Antracit RAL 7016 | 1 771,00 | 1 793,00 | 1 815,00 |
| | 093486 | 093493 | 093509 |
| TMM 2 Barna RAL 8028 | 1 771,00 | 1 793,00 | 1 815,00 |
| | 099020 * | 099044 * | 099068 |
| SSM 3 Egérszürke RAL 7005 | 1 771,00 | 1 793,00 | 1 815,00 |
| | 099013 * | 099037 * | 099051 |
| ICM 4 Fekete RAL 9005 | 1 771,00 | 1 793,00 | 1 815,00 |
| | 118448 * | 118455 * | 118462 * |
| OCM 5 Bordó RAL 3009 | 1 771,00 | 1 793,00 | 1 815,00 |
| | 118479 * | 118486 * | 118493 * |
| ZHM 6 Zöld-barna RAL 7013 | 1 771,00 | 1 793,00 | 1 815,00 |
| | 111470 * | 111487 * | 111494 |
| BHM 7 Világos ezüst RAL 9006 | 1 771,00 | 1 793,00 | 1 815,00 |
| | 118417 * | 118424 * | 118431 * |
| BM 8 Fehér RAL 9010 | 1 771,00 | 1 793,00 | 1 815,00 |
| | 133250 * | 133267 * | 133274 * |
| ZSM 9 Cinkszürke RAL extra | 1 771,00 | 1 793,00 | 1 815,00 |
| | 133342 * | 133359 * | 133366 * |
| MHM 10 Cserépszín RAL 8004 | 1 771,00 | 1 793,00 | 1 815,00 |
| | 133281 * | 133298 * | 133304 * |
| MZM 11 Mohazöld RAL 6005 | 1 771,00 | 1 793,00 | 1 815,00 |
| | 133311 * | 133328 * | 133335 * |
| BHTM 12 Sötét ezüst RAL 9007 | 1 771,00 | 1 793,00 | 1 815,00 |
| | 133229 * | 133236 * | 133243 * |
| Csomagolás db  | 15 | 15 | 15 |
| Csomagolás db  | 600 | 600 | 600 |



* Gyártás rendelésre

ALUMINIUM W.15

MATT 3D EFFECT

CSATORNATARTÓ FEKVÓERESZ

W.15-WHSG

| | |
|---|-----------------------------|
| Névleges méret | 4 |
| Anyag | 28/7 |
| Ár HUF/db | Áfával |
| ANM 1 Antracit RAL 7016 | 4 118,00 093516 |
| TMM 2 Barna RAL 8028 | 4 118,00 099082 * |
| SSM 3 Egérszürke RAL 7005 | 4 118,00 099075 * |
| ICM 4 Fekete RAL 9005 | 4 118,00 114600 * |
| OCM 5 Bordó RAL 3009 | 4 118,00 114617 * |
| ZHM 6 Zöld-barna RAL 7013 | 4 118,00 111500 * |
| BHM 7 Világos ezüst RAL 9006 | 4 118,00 114594 * |
| BM 8 Fehér RAL 9010 | 4 118,00 135605 * |
| ZSM 9 Cinkszürke RAL extra | 4 118,00 135636 * |
| MHM 10 Cserépszín RAL 8004 | 4 118,00 135612 * |
| MZM 11 Mohazöld RAL 6005 | 4 118,00 135629 * |
| BHTM 12 Sötét ezüst RAL 9007 | 4 118,00 135599 * |
| Csomagolás db  | 10 |
| Csomagolás db  | 400 |



* Gyártás rendelésre



ALUMINIUM
W.15

KÜLSŐ SZEGLET

W.15-WRA

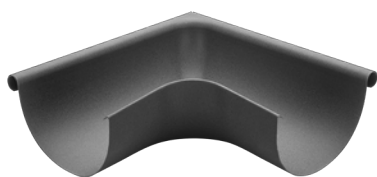

| Névleges méret | 250 | 280 | 333 |
|---|-----------------------------|-----------------------------|-----------------------------|
| Ár HUF/db | Áfával | Áfával | Áfával |
| ANM 1 Antracit RAL 7016 | 6 819,00 093905 | 7 129,00 093912 | 7 461,00 093929 |
| TMM 2 Barna RAL 8028 | 6 819,00 099822 | 7 129,00 099839 * | 7 461,00 099846 |
| SSM 3 Egérszürke RAL 7005 | 6 819,00 099792 | 7 129,00 099808 | 7 461,00 099815 |
| ICM 4 Fekete RAL 9005 | 6 819,00 118868 | 7 129,00 118875 | 7 461,00 118882 |
| OCM 5 Bordó RAL 3009 | 6 819,00 118899 * | 7 129,00 118905 * | 7 461,00 118912 * |
| ZHM 6 Zöld-barna RAL 7013 | 6 819,00 111876 | 7 129,00 111883 * | 7 461,00 111890 |
| BHM 7 Világos ezüst RAL 9006 | 6 819,00 118837 * | 7 129,00 118844 * | 7 461,00 118851 * |
| BM 8 Fehér RAL 9010 | 6 819,00 136725 * | 7 129,00 136732 * | 7 461,00 136749 |
| ZSM 9 Cinkszürke RAL extra | 6 819,00 136817 * | 7 129,00 136824 * | 7 461,00 136831 * |
| MHM 10 Cserépszín RAL 8004 | 6 819,00 136756 | 7 129,00 136763 * | 7 461,00 136770 |
| MZM 11 Mohazöld RAL 6005 | 6 819,00 136787 * | 7 129,00 136794 * | 7 461,00 136800 * |
| BHTM 12 Sötét ezüst RAL 9007 | 6 819,00 136695 * | 7 129,00 136701 * | 7 461,00 136718 * |
| Csomagolás db  | 5 | 5 | 5 |
| Csomagolás db  | 150 | 150 | 150 |

* Gyártás rendelésre



BELSŐ SZEGLET

W.15-WRI

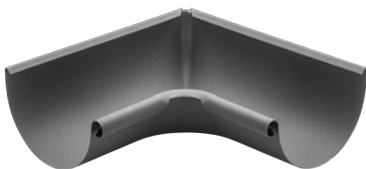

| Névleges méret | 250 | 280 | 333 |
|---|-----------------------------|-----------------------------|-----------------------------|
| Ár HUF/db | Áfával | Áfával | Áfával |
| ANM 1 Antracit RAL 7016 | 6 819,00 093950 | 7 129,00 093967 | 7 461,00 093974 |
| TMM 2 Barna RAL 8028 | 6 819,00 099884 * | 7 129,00 099891 * | 7 461,00 099907 |
| SSM 3 Egérszürke RAL 7005 | 6 819,00 099853 | 7 129,00 099860 | 7 461,00 099877 |
| ICM 4 Fekete RAL 9005 | 6 819,00 118950 * | 7 129,00 118967 * | 7 461,00 118974 |
| OCM 5 Bordó RAL 3009 | 6 819,00 118981 * | 7 129,00 118998 * | 7 461,00 119001 * |
| ZHM 6 Zöld-barna RAL 7013 | 6 819,00 111906 * | 7 129,00 111913 * | 7 461,00 111920 |
| BHM 7 Világos ezüst RAL 9006 | 6 819,00 118929 * | 7 129,00 118936 * | 7 461,00 118943 * |
| BM 8 Fehér RAL 9010 | 6 819,00 136879 * | 7 129,00 136886 * | 7 461,00 136893 |
| ZSM 9 Cinkszürke RAL extra | 6 819,00 136961 * | 7 129,00 136978 * | 7 461,00 136985 * |
| MHM 10 Cserépszín RAL 8004 | 6 819,00 136909 * | 7 129,00 136916 * | 7 461,00 136923 |
| MZM 11 Mohazöld RAL 6005 | 6 819,00 136930 * | 7 129,00 136947 * | 7 461,00 136954 * |
| BHTM 12 Sötét ezüst RAL 9007 | 6 819,00 136848 * | 7 129,00 136855 * | 7 461,00 136862 * |
| Csomagolás db  | 5 | 5 | 5 |
| Csomagolás db  | 150 | 150 | 150 |

* Gyártás rendelésre



VÉGLEMEZ

W.15-WCL



| Névleges méret | 250 | 280 | 333 |
|---|---------------------------|---------------------------|---------------------------|
| Ár HUF/db | Áfával | Áfával | Áfával |
| ANM 1 Antracit RAL 7016 | 686,00 093301 | 708,00 093318 | 731,00 093325 |
| TMM 2 Barna RAL 8028 | 686,00 098658 * | 708,00 098665 * | 731,00 098672 |
| SSM 3 Egérszürke RAL 7005 | 686,00 098764 | 708,00 098771 | 731,00 098788 |
| ICM 4 Fekete RAL 9005 | 686,00 118356 | 708,00 118363 | 731,00 118370 |
| OCM 5 Bordó RAL 3009 | 686,00 118387 * | 708,00 118394 * | 731,00 118400 |
| ZHM 6 Zöld-barna RAL 7013 | 686,00 111371 * | 708,00 111388 * | 731,00 111395 |
| BHM 7 Világos ezüst RAL 9006 | 686,00 118325 * | 708,00 118332 * | 731,00 118349 |
| BM 8 Fehér RAL 9010 | 686,00 135476 * | 708,00 135483 * | 731,00 135490 |
| ZSM 9 Cinkszürke RAL extra | 686,00 135568 * | 708,00 135575 * | 731,00 135582 * |
| MHM 10 Cserépszín RAL 8004 | 686,00 135506 | 708,00 135513 * | 731,00 135520 |
| MZM 11 Mohazöld RAL 6005 | 686,00 135537 * | 708,00 135544 * | 731,00 135551 * |
| BHTM 12 Sötét ezüst RAL 9007 | 686,00 135445 * | 708,00 135452 * | 731,00 135469 * |
| Csomagolás db  | 6/60 | 6/60 | 6/60 |
| Csomagolás db  | 1 440 | 1 440 | 1 440 |

* Gyártás rendelésre



BETORKOLLÓCSONK

W.15-WKL

| Névleges méret | 250/80 | 280/80 | 280/100 |
|---|-----------------------------|-----------------------------|-----------------------------|
| Ár HUF/db | Áfával | Áfával | Áfával |
| ANM 1 Antracit RAL 7016 | 5 203,00 093585 | 5 978,00 093592 * | 5 756,00 093608 |
| TMM 2 Barna RAL 8028 | 5 203,00 099273 | 5 978,00 099280 * | 5 756,00 099297 |
| SSM 3 Egérszürke RAL 7005 | 5 203,00 099211 | 5 978,00 099228 * | 5 756,00 099235 |
| ICM 4 Fekete RAL 9005 | 5 203,00 116864 | 5 978,00 116871 * | 5 756,00 116888 |
| OCM 5 Bordó RAL 3009 | 5 203,00 116925 * | 5 978,00 116932 * | 5 756,00 116949 * |
| ZHM 6 Zöld-barna RAL 7013 | 5 203,00 111579 | 5 978,00 111586 * | 5 756,00 111593 |
| BHM 7 Világos ezüst RAL 9006 | 5 203,00 116802 * | 5 978,00 116819 * | 5 756,00 116826 * |
| BM 8 Fehér RAL 9010 | 5 203,00 135858 * | 5 978,00 135865 * | 5 756,00 135872 * |
| ZSM 9 Cinkszürke RAL extra | 5 203,00 136039 * | 5 978,00 136046 * | 5 756,00 136053 * |
| MHM 10 Cserépszín RAL 8004 | 5 203,00 135919 | 5 978,00 135926 * | 5 756,00 135933 * |
| MZM 11 Mohazöld RAL 6005 | 5 203,00 135971 * | 5 978,00 135988 * | 5 756,00 135995 * |
| BHTM 12 Sötét ezüst RAL 9007 | 5 203,00 135797 * | 5 978,00 135803 * | 5 756,00 135810 * |
| Csomagolás db  | 15 | 15 | 15 |
| Csomagolás db  | 300 | 450 | 450 |

* Gyártás rendelésre



BETORKOLLÓCSONK

W.15-WKL

| Névleges méret | 333/80 | 333/100 | 333/120 |
|---|----------------------|----------------------|----------------------|
| Ár HUF/db | Áfával | Áfával | Áfával |
| ANM 1 Antracit RAL 7016 | 6 177,00 093615 * | 6 310,00 093622 | 8 280,00 093639 |
| TMM 2 Barna RAL 8028 | 6 177,00 099303 * | 6 310,00 099310 | 8 280,00 099327 |
| SSM 3 Egérszürke RAL 7005 | 6 177,00 099242 * | 6 310,00 099259 | 8 280,00 099266 |
| ICM 4 Fekete RAL 9005 | 6 177,00 116895 * | 6 310,00 116901 | 8 280,00 116918 * |
| OCM 5 Bordó RAL 3009 | 6 177,00 116956 * | 6 310,00 116963 * | 8 280,00 116970 * |
| ZHM 6 Zöld-barna RAL 7013 | 6 177,00 111609 * | 6 310,00 111616 | 8 280,00 111623 |
| BHM 7 Világos ezüst RAL 9006 | 6 177,00 116833 * | 6 310,00 116840 * | 8 280,00 116857 * |
| BM 8 Fehér RAL 9010 | 6 177,00 135889 * | 6 310,00 135896 | 8 280,00 135902 * |
| ZSM 9 Cinkszürke RAL extra | 6 177,00 136060 * | 6 310,00 136077 * | 8 280,00 136084 * |
| MHM 10 Cserépszín RAL 8004 | 6 177,00 135940 | 6 310,00 135957 | 8 280,00 135964 |
| MZM 11 Mohazöld RAL 6005 | 6 177,00 136008 * | 6 310,00 136015 * | 8 280,00 136022 * |
| BHTM 12 Sötét ezüst RAL 9007 | 6 177,00 135827 * | 6 310,00 135834 * | 8 280,00 135841 * |
| Csomagolás db  | 15 | 15 | 10 |
| Csomagolás db  | 450 | 450 | 200 |

* Gyártás rendelésre



ALUMINIUM W.15

MATT 3D EFFECT

KÍNÁLATUNKBAN SZEREPEL EGY ÚJ, FÉDER RÖGZÍTŐ RENDSZERREL RENDELKEZŐ PREMIUM ŐST, AMELY LEHETŐVÉ TESZI A KÖNYÖK IGÉNYELT IRÁNYBA TÖRTÉNYŐ KÖNNYŰ ELFORDÍTÁSÁT, ES MINDEN HELYZETBEN MEGBÍZHATÓAN TARTJA HELYZETÉT, BÁRMILYEN KÖNYÖKRE SZEGECSELÉS NÉLKÜL FELSZERELHETŐ.

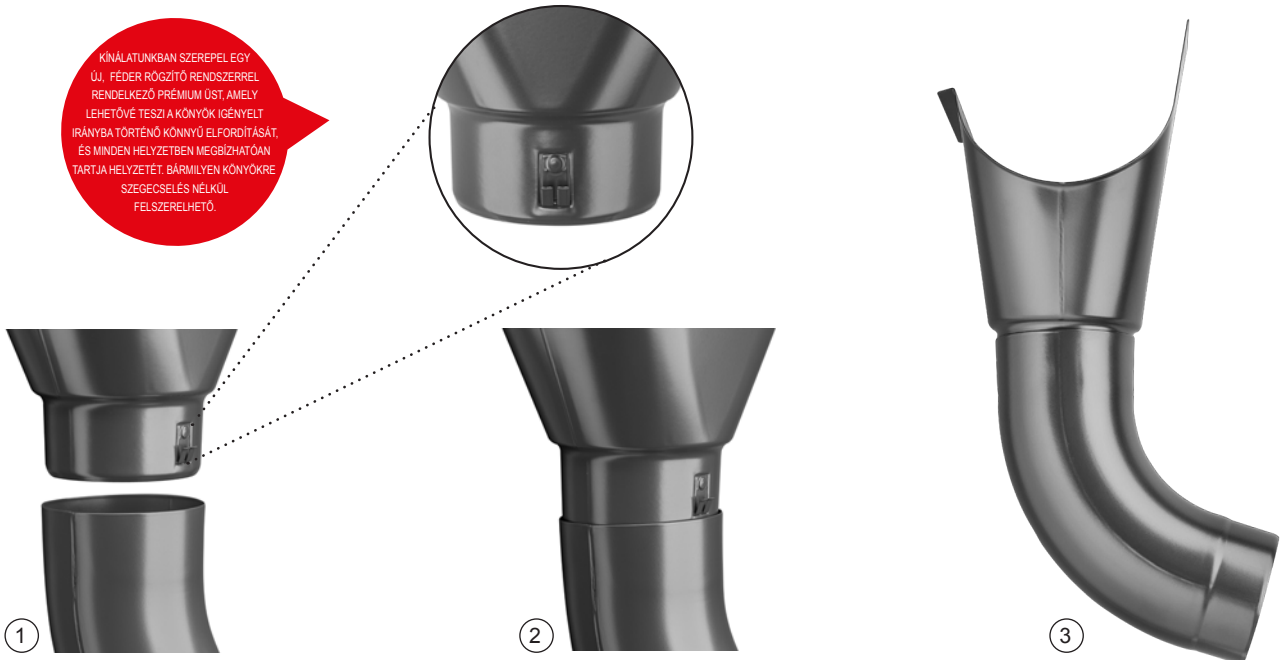



ALUMINIUM W.15

MATT 3D EFFECT

ROZSDAMENTES ACÉL LOMBKOSÁR

N-NZN



| Névleges méret | EAN szám | Csomagolás db | | Ár áfával [HUF/db] |
|----------------|----------|---------------|-------|--------------------|
| | | | | |
| 60 | 001153 | 30 | 2 160 | 2 460,00 |
| 80 | 001160 | 20 | 1 440 | 2 480,00 |
| 100 | 001177 | 15 | 1 080 | 2 520,00 |
| 120 | 001184 | 10 | 720 | 2 750,00 |
| 150 | 001191 | 5 | 360 | 4 340,00 |





ALUMINIUM W.15

MATT 3D EFFECT

VÍZGYÜJTŐ ÜST DESIGN

W.15-WKLZ DE

| Névleges méret | 80 | 100 | 120 |
|---|------------------------------|------------------------------|------------------------------|
| Ár HUF/db | Áfával | Áfával | Áfával |
| ANM 1 Antracit RAL 7016 | 46 007,00 093677 * | 46 007,00 093721 | 48 354,00 093776 * |
| TMM 2 Barna RAL 8028 | 46 007,00 100634 * | 46 007,00 100689 * | 48 354,00 100733 * |
| SSM 3 Egérszürke RAL 7005 | 46 007,00 100481 * | 46 007,00 100535 * | 48 354,00 100580 * |
| ICM 4 Fekete RAL 9005 | 46 007,00 138606 * | 46 007,00 138651 * | 48 354,00 138705 * |
| OCM 5 Bordó RAL 3009 | 46 007,00 139054 * | 46 007,00 139108 * | 48 354,00 139153 * |
| ZHM 6 Zöld-barna RAL 7013 | 46 007,00 111647 * | 46 007,00 111692 * | 48 354,00 111746 * |
| BHM 7 Világos ezüst RAL 9006 | 46 007,00 138156 * | 46 007,00 138200 * | 48 354,00 138255 * |
| BM 8 Fehér RAL 9010 | 46 007,00 138453 * | 46 007,00 138507 * | 48 354,00 138552 * |
| ZSM 9 Cinkszürke RAL extra | 46 007,00 139207 * | 46 007,00 139252 * | 48 354,00 139306 * |
| MHM 10 Cserépszín RAL 8004 | 46 007,00 138750 * | 46 007,00 138804 * | 48 354,00 138859 * |
| MZM 11 Mohazöld RAL 6005 | 46 007,00 138903 * | 46 007,00 138958 * | 48 354,00 139009 * |
| BHTM 12 Sötét ezüst RAL 9007 | 46 007,00 138309 * | 46 007,00 138354 * | 48 354,00 138408 * |
| Csomagolás db  | 2 | 2 | 2 |
| Csomagolás db  | 36 | 36 | 36 |

* Gyártás rendelésre



ALUMINIUM W.15

MATT 3D EFFECT

VÍZGYÜJTŐ ÜST DESIGN EXCENTRIKUS

W.15-WKLZ DX



| Névleges méret | 80 | 100 | 120 |
|---|------------------------------|------------------------------|------------------------------|
| Ár HUF/db | Áfával | Áfával | Áfával |
| ANM 1 Antracit RAL 7016 | 52 959,00 093660 * | 52 959,00 093714 | 57 564,00 093769 * |
| TMM 2 Barna RAL 8028 | 52 959,00 100627 * | 52 959,00 100672 * | 57 564,00 100726 * |
| SSM 3 Egérszürke RAL 7005 | 52 959,00 100474 * | 52 959,00 100528 * | 57 564,00 100573 * |
| ICM 4 Fekete RAL 9005 | 52 959,00 138613 * | 52 959,00 138668 * | 57 564,00 138712 * |
| OCM 5 Bordó RAL 3009 | 52 959,00 139061 * | 52 959,00 139115 * | 57 564,00 139160 * |
| ZHM 6 Zöld-barna RAL 7013 | 52 959,00 111630 * | 52 959,00 111685 * | 57 564,00 111739 * |
| BHM 7 Világos ezüst RAL 9006 | 52 959,00 138163 * | 52 959,00 138217 * | 57 564,00 138262 * |
| BM 8 Fehér RAL 9010 | 52 959,00 138460 * | 52 959,00 138514 * | 57 564,00 138569 * |
| ZSM 9 Cinkszürke RAL extra | 52 959,00 139214 * | 52 959,00 139269 * | 57 564,00 139313 * |
| MHM 10 Cserépszín RAL 8004 | 52 959,00 138767 * | 52 959,00 138811 * | 57 564,00 138866 * |
| MZM 11 Mohazöld RAL 6005 | 52 959,00 138910 * | 52 959,00 138965 * | 57 564,00 139016 * |
| BHTM 12 Sötét ezüst RAL 9007 | 52 959,00 138316 * | 52 959,00 138361 * | 57 564,00 138415 * |
| Csomagolás db | 2 | 2 | 2 |
| Csomagolás db | 36 | 36 | 36 |



* Gyártás rendelésre

ALUMINIUM W.15

MATT 3D EFFECT

VÍZGYÜJTŐ ÜST KÖBÖS

W.15-WKLZ KU

| Névleges méret | 80 | 100 | 120 |
|---|------------------------------|------------------------------|------------------------------|
| Ár HUF/db | Áfával | Áfával | Áfával |
| ANM 1 Antracit RAL 7016 | 58 937,00 093684 * | 58 937,00 093738 * | 66 774,00 093783 * |
| TMM 2 Barna RAL 8028 | 58 937,00 100641 * | 58 937,00 100696 * | 66 774,00 100740 * |
| SSM 3 Egérszürke RAL 7005 | 58 937,00 100498 * | 58 937,00 100542 * | 66 774,00 100597 * |
| ICM 4 Fekete RAL 9005 | 58 937,00 138620 * | 58 937,00 138675 * | 66 774,00 138729 * |
| OCM 5 Bordó RAL 3009 | 58 937,00 139078 * | 58 937,00 139122 * | 66 774,00 139177 * |
| ZHM 6 Zöld-barna RAL 7013 | 58 937,00 111654 * | 58 937,00 111708 * | 66 774,00 111753 * |
| BHM 7 Világos ezüst RAL 9006 | 58 937,00 138170 * | 58 937,00 138224 * | 66 774,00 138279 * |
| BM 8 Fehér RAL 9010 | 58 937,00 138477 * | 58 937,00 138521 * | 66 774,00 138576 * |
| ZSM 9 Cinkszürke RAL extra | 58 937,00 139221 * | 58 937,00 139276 * | 66 774,00 139320 * |
| MHM 10 Cserépszín RAL 8004 | 58 937,00 138774 * | 58 937,00 138828 * | 66 774,00 138873 * |
| MZM 11 Mohazöld RAL 6005 | 58 937,00 138927 * | 58 937,00 138972 * | 66 774,00 139023 * |
| BHTM 12 Sötét ezüst RAL 9007 | 58 937,00 138323 * | 58 937,00 138378 * | 66 774,00 138422 * |
| Csomagolás db  | 2 | 2 | 2 |
| Csomagolás db  | 36 | 36 | 36 |



* Gyártás rendelésre



VÍZGYÜJTŐ ÜST KÖBÖS EXCENTRIKUS

W.15-WKLZ KX



| Névleges méret | 80 | 100 | 120 |
|---|------------------------------|------------------------------|------------------------------|
| Ár HUF/db | Áfával | Áfával | Áfával |
| ANM 1 Antracit RAL 7016 | 62 169,00 093707 * | 62 169,00 093752 | 66 774,00 093806 * |
| TMM 2 Barna RAL 8028 | 62 169,00 100665 * | 62 169,00 100719 | 66 774,00 100764 * |
| SSM 3 Egérszürke RAL 7005 | 62 169,00 100511 * | 62 169,00 100566 | 66 774,00 100610 * |
| ICM 4 Fekete RAL 9005 | 62 169,00 138637 * | 62 169,00 138682 * | 66 774,00 138736 * |
| OCM 5 Bordó RAL 3009 | 62 169,00 139085 * | 62 169,00 139139 * | 66 774,00 139184 * |
| ZHM 6 Zöld-barna RAL 7013 | 62 169,00 111678 * | 62 169,00 111722 | 66 774,00 111777 * |
| BHM 7 Világos ezüst RAL 9006 | 62 169,00 138187 * | 62 169,00 138231 * | 66 774,00 138286 * |
| BM 8 Fehér RAL 9010 | 62 169,00 138484 * | 62 169,00 138538 * | 66 774,00 138583 * |
| ZSM 9 Cinkszürke RAL extra | 62 169,00 139238 * | 62 169,00 139283 * | 66 774,00 139337 * |
| MHM 10 Cserépszín RAL 8004 | 62 169,00 138781 * | 62 169,00 138835 * | 66 774,00 138880 * |
| MZM 11 Mohazöld RAL 6005 | 62 169,00 138934 * | 62 169,00 138989 * | 66 774,00 139030 * |
| BHTM 12 Sötét ezüst RAL 9007 | 62 169,00 138330 * | 62 169,00 138385 * | 66 774,00 138439 * |
| Csomagolás db  | 2 | 2 | 2 |
| Csomagolás db  | 36 | 36 | 36 |



* Gyártás rendelésre

ALUMINIUM W.15

MATT 3D EFFECT

VÍZGYÜJTŐ ÜST KÖBÖS KIFOLYÁSSAL EXCENTRIKUS W.15-WKLZ KXV





| Névleges méret | 80 | 100 | 120 |
|---|------------------------------|------------------------------|------------------------------|
| Ár HUF/db | Áfával | Áfával | Áfával |
| ANM 1 Antracit RAL 7016 | 73 682,00 093691 * | 73 682,00 093745 * | 78 287,00 093790 * |
| TMM 2 Barna RAL 8028 | 73 682,00 100658 * | 73 682,00 100702 * | 78 287,00 100757 * |
| SSM 3 Egérszürke RAL 7005 | 73 682,00 100504 * | 73 682,00 100559 * | 78 287,00 100603 * |
| ICM 4 Fekete RAL 9005 | 73 682,00 138644 * | 73 682,00 138699 * | 78 287,00 138743 * |
| OCM 5 Bordó RAL 3009 | 73 682,00 139092 * | 73 682,00 139146 * | 78 287,00 139191 * |
| ZHM 6 Zöld-barna RAL 7013 | 73 682,00 111661 * | 73 682,00 111715 * | 78 287,00 111760 * |
| BHM 7 Világos ezüst RAL 9006 | 73 682,00 138194 * | 73 682,00 138248 * | 78 287,00 138293 * |
| BM 8 Fehér RAL 9010 | 73 682,00 138491 * | 73 682,00 138545 * | 78 287,00 138590 * |
| ZSM 9 Cinkszürke RAL extra | 73 682,00 139245 * | 73 682,00 139290 * | 78 287,00 139344 * |
| MHM 10 Cserépszín RAL 8004 | 73 682,00 138798 * | 73 682,00 138842 * | 78 287,00 138897 * |
| MZM 11 Mohazöld RAL 6005 | 73 682,00 138941 * | 73 682,00 138996 * | 78 287,00 139047 * |
| BHTM 12 Sötét ezüst RAL 9007 | 73 682,00 138347 * | 73 682,00 138392 * | 78 287,00 138446 * |
| Csomagolás db  | 2 | 2 | 2 |
| Csomagolás db  | 36 | 36 | 36 |

* Gyártás rendelésre

TÖMÍTŐ GUMI VÍZGYUJTÓ ŰSTRE

P-PKLZ T



| Névleges méret | EAN szám | Csomagolás db | | Ár áfával [HUF/db] |
|-------------------|----------|---|---|--------------------|
| | |  |  | |
| IC 70-85 | 077103 | 5 | 600 | 1 770,00 |
| IC 100-110 | 077110 | 5 | 600 | 1 820,00 |
| IC 110-125 | 077097 | 5 | 600 | 1 860,00 |
| PS 70-85 | 077134 | 5 | 600 | 1 990,00 |
| PS 100-110 | 077141 | 5 | 600 | 2 170,00 |
| PS 110-125 | 077127 | 5 | 600 | 2 210,00 |

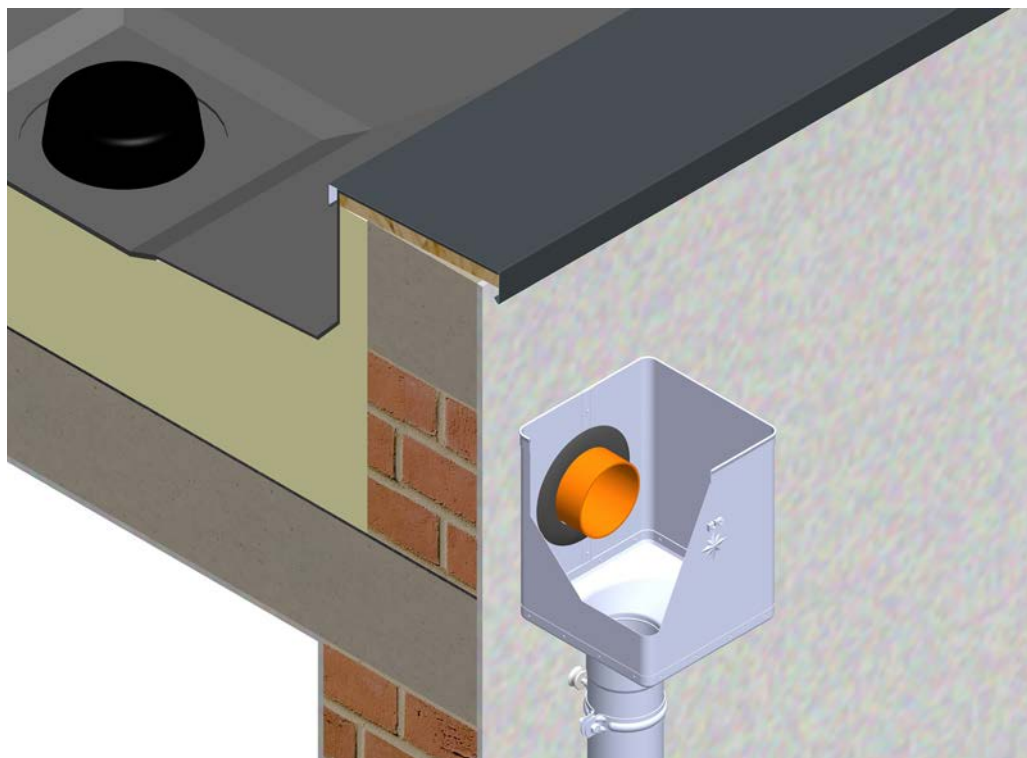



ALUMINIUM W.15

MATT 3D EFFECT

KÖNYÖK 72°

W.15-WK

| Névleges méret | 80 | 100 | 120 |
|---|-----------------------------|-----------------------------|-----------------------------|
| Ár HUF/db | Áfával | Áfával | Áfával |
| ANM 1 Antracit RAL 7016 | 4 140,00 093523 | 4 428,00 093547 | 6 731,00 093561 |
| TMM 2 Barna RAL 8028 | 4 140,00 099129 | 4 428,00 099136 | 6 731,00 099143 |
| SSM 3 Egérszürke RAL 7005 | 4 140,00 099099 | 4 428,00 099105 | 6 731,00 099112 |
| ICM 4 Fekete RAL 9005 | 4 140,00 116567 | 4 428,00 116574 | 6 731,00 116581 * |
| OCM 5 Bordó RAL 3009 | 4 140,00 116598 * | 4 428,00 116604 * | 6 731,00 116611 * |
| ZHM 6 Zöld-barna RAL 7013 | 4 140,00 111517 | 4 428,00 111531 | 6 731,00 111555 |
| BHM 7 Világos ezüst RAL 9006 | 4 140,00 116536 * | 4 428,00 116543 * | 6 731,00 116550 * |
| BM 8 Fehér RAL 9010 | 4 140,00 135674 * | 4 428,00 135681 | 6 731,00 135698 * |
| ZSM 9 Cinkszürke RAL extra | 4 140,00 135766 * | 4 428,00 135773 * | 6 731,00 135780 * |
| MHM 10 Cserépszín RAL 8004 | 4 140,00 135704 | 4 428,00 135711 | 6 731,00 135728 |
| MZM 11 Mohazöld RAL 6005 | 4 140,00 135735 * | 4 428,00 135742 * | 6 731,00 135759 * |
| BHTM 12 Sötét ezüst RAL 9007 | 4 140,00 135643 * | 4 428,00 135650 * | 6 731,00 135667 * |
| Csomagolás db  | 4 | 4 | 2 |
| Csomagolás db  | 240 | 120 | 120 |



* Gyártás rendelésre



ALUMINIUM
W.15

KÖNYÖK 85°

W.15-WKR

| Névleges méret | 80 | 100 | 120 |
|---|-----------------------------|-----------------------------|-----------------------------|
| Ár HUF/db | Áfával | Áfával | Áfával |
| ANM 1 Antracit RAL 7016 | 5 225,00 093530 * | 6 022,00 093554 | 8 059,00 093578 * |
| TMM 2 Barna RAL 8028 | 5 225,00 099167 * | 6 022,00 099181 | 8 059,00 099204 * |
| SSM 3 Egérszürke RAL 7005 | 5 225,00 099150 * | 6 022,00 099174 | 8 059,00 099198 * |
| ICM 4 Fekete RAL 9005 | 5 225,00 116628 * | 6 022,00 116635 * | 8 059,00 116642 * |
| OCM 5 Bordó RAL 3009 | 5 225,00 116659 * | 6 022,00 116666 * | 8 059,00 116673 * |
| ZHM 6 Zöld-barna RAL 7013 | 5 225,00 111524 * | 6 022,00 111548 | 8 059,00 111562 * |
| BHM 7 Világos ezüst RAL 9006 | 5 225,00 116680 * | 6 022,00 116697 * | 8 059,00 116703 * |
| BM 8 Fehér RAL 9010 | 5 225,00 136275 * | 6 022,00 136282 | 8 059,00 136299 * |
| ZSM 9 Cinkszürke RAL extra | 5 225,00 136367 * | 6 022,00 136374 * | 8 059,00 136381 * |
| MHM 10 Cserépszín RAL 8004 | 5 225,00 136305 * | 6 022,00 136312 * | 8 059,00 136329 * |
| MZM 11 Mohazöld RAL 6005 | 5 225,00 136336 * | 6 022,00 136343 * | 8 059,00 136350 * |
| BHTM 12 Sötét ezüst RAL 9007 | 5 225,00 136244 * | 6 022,00 136251 * | 8 059,00 136268 * |
| Csomagolás db  | 4 | 4 | 4 |
| Csomagolás db  | 240 | 120 | 120 |

* Gyártás rendelésre





ALUMINIUM W.15

MATT 3D EFFECT

KÖNYÖK 40°

W.15-WKT

| Névleges méret | 80 | 100 | 120 |
|---|-----------------------------|-----------------------------|-----------------------------|
| Ár HUF/db | Áfával | Áfával | Áfával |
| ANM 1 Antracit RAL 7016 | 5 159,00 093530 * | 6 443,00 093554 | 8 280,00 093578 * |
| TMM 2 Barna RAL 8028 | 5 159,00 099167 * | 6 443,00 099181 | 8 280,00 099204 * |
| SSM 3 Egérszürke RAL 7005 | 5 159,00 099150 * | 6 443,00 099174 | 8 280,00 099198 * |
| ICM 4 Fekete RAL 9005 | 5 159,00 116628 * | 6 443,00 116635 * | 8 280,00 116642 * |
| OCM 5 Bordó RAL 3009 | 5 159,00 116659 * | 6 443,00 116666 * | 8 280,00 116673 * |
| ZHM 6 Zöld-barna RAL 7013 | 5 159,00 111524 * | 6 443,00 111548 | 8 280,00 111562 * |
| BHM 7 Világos ezüst RAL 9006 | 5 159,00 116680 * | 6 443,00 116697 * | 8 280,00 116703 * |
| BM 8 Fehér RAL 9010 | 5 159,00 136275 * | 6 443,00 136282 | 8 280,00 136299 * |
| ZSM 9 Cinkszürke RAL extra | 5 159,00 136367 * | 6 443,00 136374 * | 8 280,00 136381 * |
| MHM 10 Cserépszín RAL 8004 | 5 159,00 136305 * | 6 443,00 136312 * | 8 280,00 136329 * |
| MZM 11 Mohazöld RAL 6005 | 5 159,00 136336 * | 6 443,00 136343 * | 8 280,00 136350 * |
| BHTM 12 Sötét ezüst RAL 9007 | 5 159,00 136244 * | 6 443,00 136251 * | 8 280,00 136268 * |
| Csomagolás db  | 4 | 4 | 4 |
| Csomagolás db  | 240 | 120 | 120 |

* Gyártás rendelésre





ALUMINIUM W.15

MATT 3D EFFECT

LEFOLYÓCSŐ [s=0,70]

W.15-WZR





| Névleges méret | 80 | 100 | 100 | 120 |
|--|----------------|----------|----------|----------|
| Hossz m | 3,0 | 3,0 | 4,0 | 3,0 |
| Ár HUF/m | Áfával | Áfával | Áfával | Áfával |
| ANM Antracit RAL 7016 | 1 3 432,00 | 3 675,00 | 3 675,00 | 4 959,00 |
| | 094131 | 094148 | 094155 | 094162 |
| TMM Barna RAL 8028 | 2 3 432,00 | 3 675,00 | 3 675,00 | 4 959,00 |
| | 100177 | 100184 | 100191 | 100207 |
| SSM Egérszürke RAL 7005 | 3 3 432,00 | 3 675,00 | 3 675,00 | 4 959,00 |
| | 100139 | 100146 | 100153 | 100160 |
| ICM Fekete RAL 9005 | 4 3 432,00 | 3 675,00 | 3 675,00 | 4 959,00 |
| | 115294 | 115300 | 115317 | 115324 |
| OCM Bordó RAL 3009 | 5 3 432,00 | 3 675,00 | 3 675,00 | 4 959,00 |
| | 115331 | 115348 | 115355 | 115362 |
| ZHM Zöld-barna RAL 7013 | 6 3 432,00 | 3 675,00 | 3 675,00 | 4 959,00 |
| | 112088 | 112095 | 112101 * | 112118 |
| BHM Világos ezüst RAL 9006 | 7 3 432,00 | 3 675,00 | 3 675,00 | 4 959,00 |
| | 115249 | 115256 | 115263 | 115287 |
| BM Fehér RAL 9010 | 8 3 432,00 | 3 675,00 | 3 675,00 | 4 959,00 |
| | 132598 | 132604 | 132611 | 132628 * |
| ZSM Cinkszürke RAL extra | 9 3 432,00 | 3 675,00 | 3 675,00 | 4 959,00 |
| | 132680 * | 132727 * | 132734 * | 132789 * |
| MHM Cserépszín RAL 8004 | 10 3 432,00 | 3 675,00 | 3 675,00 | 4 959,00 |
| | 132673 * | 132703 * | 132758 * | 132765 * |
| MZM Mohazöld RAL 6005 | 11 3 432,00 | 3 675,00 | 3 675,00 | 4 959,00 |
| | 132697 * | 132710 * | 132741 * | 132772 * |
| BHTM Sötét ezüst RAL 9007 | 12 3 432,00 | 3 675,00 | 3 675,00 | 4 959,00 |
| | 132635 * | 132642 * | 132659 * | 132666 * |
| Csomagolás m  | 18 | 18 | 24 | 18 |
| Csomagolás m  | 216 | 180 | 240 | 144 |

* Gyártás rendelésre



IDEIGLENES FÓLIACSŐ

SD-ZR FOLIA KJG



| Névleges méret | Hossz m | EAN szám | Csomagolás m | | Ár áfával [HUF/m] |
|----------------|---------|----------|---|---|-------------------|
| | | |  |  | |
| 60-150 | 100,0 | 139726 | 100 | 6 000 | 170,00 |

ALUMINIUM W.15

MATT 3D EFFECT

LÁBAZATI ELEM

W.15-WKO

| Névleges méret | 80 | 100 | 120 |
|---|-----------------------------|-----------------------------|-----------------------------|
| Ár HUF/db | Áfával | Áfával | Áfával |
| ANM 1 Antracit RAL 7016 | 5 070,00 093813 | 6 199,00 093820 | 7 350,00 093837 |
| TMM 2 Barna RAL 8028 | 5 070,00 099389 * | 6 199,00 099402 * | 7 350,00 099426 * |
| SSM 3 Egérszürke RAL 7005 | 5 070,00 099372 | 6 199,00 099396 | 7 350,00 099419 * |
| ICM 4 Fekete RAL 9005 | 5 070,00 118639 * | 6 199,00 118646 | 7 350,00 118653 * |
| OCM 5 Bordó RAL 3009 | 5 070,00 118660 * | 6 199,00 118677 * | 7 350,00 118684 * |
| ZHM 6 Zöld-barna RAL 7013 | 5 070,00 111784 * | 6 199,00 111791 * | 7 350,00 111807 * |
| BHM 7 Világos ezüst RAL 9006 | 5 070,00 118608 * | 6 199,00 118615 * | 7 350,00 118622 * |
| BM 8 Fehér RAL 9010 | 5 070,00 136213 * | 6 199,00 136220 | 7 350,00 136237 * |
| ZSM 9 Cinkszürke RAL extra | 5 070,00 136152 * | 6 199,00 136169 * | 7 350,00 136176 * |
| MHM 10 Cserépszín RAL 8004 | 5 070,00 136091 * | 6 199,00 136107 | 7 350,00 136114 * |
| MZM 11 Mohazöld RAL 6005 | 5 070,00 136121 * | 6 199,00 136138 * | 7 350,00 136145 * |
| BHTM 12 Sötét ezüst RAL 9007 | 5 070,00 136183 * | 6 199,00 136190 * | 7 350,00 136206 * |
| Csomagolás db  | 4 | 4 | 2 |
| Csomagolás db  | 240 | 120 | 120 |

* Gyártás rendelésre



ALUMINIUM
W.15

Y-ELÁGAZÁS 72°

W.15-WZO



| Névleges méret | 80/80 | 100/80 | 100/100 |
|---|-----------------------|-----------------------|-----------------------|
| Ár HUF/db | Áfával | Áfával | Áfával |
| ANM 1 Antracit RAL 7016 | 17 712,00 094070 * | 18 199,00 094087 * | 18 376,00 094094 |
| TMM 2 Barna RAL 8028 | 17 712,00 100412 * | 18 199,00 100429 * | 18 376,00 100436 * |
| SSM 3 Egérszürke RAL 7005 | 17 712,00 100351 * | 18 199,00 100368 * | 18 376,00 100375 * |
| ICM 4 Fekete RAL 9005 | 17 712,00 119018 * | 18 199,00 119049 * | 18 376,00 119087 * |
| OCM 5 Bordó RAL 3009 | 17 712,00 119025 * | 18 199,00 119063 * | 18 376,00 119094 * |
| ZHM 6 Zöld-barna RAL 7013 | 17 712,00 112026 * | 18 199,00 112033 * | 18 376,00 112040 * |
| BHM 7 Világos ezüst RAL 9006 | 17 712,00 119032 * | 18 199,00 119056 * | 18 376,00 119070 * |
| BM 8 Fehér RAL 9010 | 17 712,00 137258 * | 18 199,00 137265 * | 18 376,00 137272 * |
| ZSM 9 Cinkszürke RAL extra | 17 712,00 137432 * | 18 199,00 137449 * | 18 376,00 137456 * |
| MHM 10 Cserépszín RAL 8004 | 17 712,00 137319 * | 18 199,00 137326 * | 18 376,00 137333 * |
| MZM 11 Mohazöld RAL 6005 | 17 712,00 137371 * | 18 199,00 137388 * | 18 376,00 137395 * |
| BHTM 12 Sötét ezüst RAL 9007 | 17 712,00 137197 * | 18 199,00 137203 * | 18 376,00 137210 * |
| Csomagolás db | 4 | 4 | 4 |
| Csomagolás db | 120 | 120 | 120 |

* Gyártás rendelésre

ALUMINIUM W.15

MATT 3D EFFECT

Y-ELÁGAZÁS 72°

W.15-WZO



| Névleges méret | 120/80 | 120/100 | 120/120 |
|---|------------------------------|------------------------------|------------------------------|
| Ár HUF/db | Áfával | Áfával | Áfával |
| ANM 1 Antracit RAL 7016 | 19 837,00 094100 * | 20 059,00 094117 * | 20 192,00 094124 * |
| TMM 2 Barna RAL 8028 | 19 837,00 100443 * | 20 059,00 100450 * | 20 192,00 100467 * |
| SSM 3 Egérszürke RAL 7005 | 19 837,00 100382 * | 20 059,00 100399 * | 20 192,00 100405 * |
| ICM 4 Fekete RAL 9005 | 19 837,00 119117 * | 20 059,00 119148 * | 20 192,00 119179 * |
| OCM 5 Bordó RAL 3009 | 19 837,00 119100 * | 20 059,00 119155 * | 20 192,00 119186 * |
| ZHM 6 Zöld-barna RAL 7013 | 19 837,00 112057 * | 20 059,00 112064 * | 20 192,00 112071 * |
| BHM 7 Világos ezüst RAL 9006 | 19 837,00 119124 * | 20 059,00 119131 * | 20 192,00 119162 * |
| BM 8 Fehér RAL 9010 | 19 837,00 137289 * | 20 059,00 137296 * | 20 192,00 137302 * |
| ZSM 9 Cinkszürke RAL extra | 19 837,00 137463 * | 20 059,00 137470 * | 20 192,00 137487 * |
| MHM 10 Cserépszín RAL 8004 | 19 837,00 137340 * | 20 059,00 137357 * | 20 192,00 137364 * |
| MZM 11 Mohazöld RAL 6005 | 19 837,00 137401 * | 20 059,00 137418 * | 20 192,00 137425 * |
| BHTM 12 Sötét ezüst RAL 9007 | 19 837,00 137227 * | 20 059,00 137234 * | 20 192,00 137241 * |
| Csomagolás db  | 3 | 3 | 3 |
| Csomagolás db  | 90 | 90 | 90 |

* Gyártás rendelésre



BILINCSFEJ MENETES M10

W.15-WOB

| Névleges méret | 80 | 100 | 120 |
|---|----------------------|----------------------|----------------------|
| Ár HUF/db | Áfával | Áfával | Áfával |
| ANM 1 Antracit RAL 7016 | 1 506,00 093875 | 1 572,00 093882 | 1 793,00 093899 |
| TMM 2 Barna RAL 8028 | 1 506,00 099761 | 1 572,00 099778 | 1 793,00 099785 |
| SSM 3 Egérszürke RAL 7005 | 1 506,00 099730 | 1 572,00 099747 | 1 793,00 099754 |
| ICM 4 Fekete RAL 9005 | 1 506,00 118530 | 1 572,00 118547 | 1 793,00 118554 * |
| OCM 5 Bordó RAL 3009 | 1 506,00 118561 * | 1 572,00 118578 * | 1 793,00 118585 * |
| ZHM 6 Zöld-barna RAL 7013 | 1 506,00 111845 | 1 572,00 111852 | 1 793,00 111869 |
| BHM 7 Világos ezüst RAL 9006 | 1 506,00 118509 * | 1 572,00 118516 * | 1 793,00 118523 * |
| BM 8 Fehér RAL 9010 | 1 506,00 136572 * | 1 572,00 136589 | 1 793,00 136596 * |
| ZSM 9 Cinkszürke RAL extra | 1 506,00 136664 * | 1 572,00 136671 * | 1 793,00 136688 * |
| MHM 10 Cserépszín RAL 8004 | 1 506,00 136602 | 1 572,00 136619 | 1 793,00 136626 |
| MZM 11 Mohazöld RAL 6005 | 1 506,00 136633 * | 1 572,00 136640 * | 1 793,00 136657 * |
| BHTM 12 Sötét ezüst RAL 9007 | 1 506,00 136541 * | 1 572,00 136558 * | 1 793,00 136565 * |
| Csomagolás db  | 10 | 10 | 10 |
| Csomagolás db  | 1 200 | 1 200 | 1 200 |

* Gyártás rendelésre





ALUMINIUM W.15

MATT 3D EFFECT

ROZSDAMENTES ÁCEL CSAVAR BILINCSHEZ M8x30

P-POB-NSK



| Névleges méret | EAN szám | Csomagolás db | | Ár áfával [HUF/db] |
|----------------|----------|---|---|--------------------|
| | |  |  | |
| M8 x 30 * | 139658 | 1 | – | 110,00 |



* Gyártás rendelésre

CSAVAR BILINCSHEZ MENETES SZÁRRAL TORX M10

P-POB-HT





ALUMINIUM W.15

| Névleges méret | EAN szám | Csomagolás db | | Ár áfával [HUF/db] |
|----------------|----------|---|---|--------------------|
| | |  |  | |
| 80 | 002464 | 100 | 40 000 | 440,00 |
| 140 | 002471 | 100 | 28 000 | 550,00 |
| 200 | 002488 | 100 | 20 000 | 690,00 |
| 250 | 002495 | 100 | 16 000 | 750,00 |
| 300 | 002501 | 100 | 11 200 | 750,00 |

TIPLI M10

P-POB-HN DB





| Névleges méret | EAN szám | Csomagolás db | | Ár áfával [HUF/db] |
|----------------|----------|---|---|--------------------|
| | |  |  | |
| 120 | 002426 | 100 | 25 000 | 180,00 |

TIPLI ZÁRO KUPAKALL M10

P-POB-HN DB





| Névleges méret | EAN szám | Csomagolás db | | Ár áfával [HUF/db] |
|----------------|----------|---|---|--------------------|
| | |  |  | |
| 180 | 002433 | 100 | 12 000 | 190,00 |
| 240 | 002440 | 100 | 12 000 | 220,00 |
| 280 | 002457 | 100 | 12 000 | 230,00 |

TŐCSAVAR TORX M10

P-POB-ZT/SZ



| Névleges méret | EAN szám | Csomagolás db | | Ár áfával [HUF/db] |
|----------------|----------|---|---|--------------------|
| | |  |  | |
| 140 | 002587 | 50 | 10 400 | 200,00 |
| 180 | 002594 | 50 | 10 400 | 240,00 |



ALUMINIUM W.15

MATT 3D EFFECT

HUNGAROCCELL TIPLI M10



P-POB-HN IZOL



| Névleges méret | EAN szám | Csomagolás db | | Ár áfával [HUF/db] |
|----------------|----------|---|---|--------------------|
| | |  |  | |
| M10 x 96 | 001207 | 25 | 2 625 | 1 200,00 |



SZIGETELŐ DÜBEL CSAVARHEGY TÉGLA SZIGETELÉS NÉLKÜL P-POB-HN WDVS140 M10



| Névleges méret | EAN szám | Csomagolás db | | Ár áfával [HUF/db] |
|----------------|----------|---|---|--------------------|
| | |  |  | |
| 140 | 144843 | 1/5 | 750 | 2 130,00 |



SZIGETELŐ DÜBEL CSAVARHEGY SZIGETELÉSSEL ELLÁTOTT TÉGLA P-POB-HN WDVS300 M10



| Névleges méret | EAN szám | Csomagolás db | | Ár áfával [HUF/db] |
|----------------|----------|---|---|--------------------|
| | |  |  | |
| 300 | 144850 | 1/5 | 500 | 3 450,00 |

ROZSDAMENTES ACÉL UNI PLATFORM OB M10 MÉRETŰ BILINGS RÖGZÍTÉSÉHEZ P-POB-HN PLAT M10



| Névleges méret | EAN szám | Csomagolás db | | Ár áfával [HUF/db] |
|----------------|----------|---|---|--------------------|
| | |  |  | |
| M10 | 144836 | 25/500 | 5 000 | 1 480,00 |



ALUMINIUM W.15

MATT 3D EFFECT

MENETES RÚD M10

P-POB-ZT





| Névleges méret | EAN szám | Csomagolás db | | Ár áfával [HUF/db] |
|----------------|----------|---|---|--------------------|
| | |  |  | |
| 60 | 002556 | 100 | 20 800 | 90,00 |
| 100 | 002563 | 100 | 15 600 | 130,00 |
| 150 | 002570 | 50 | 10 400 | 240,00 |

FALRA ROGZÍTHETŐ CSÖBILINCS TALP M10

P-POB-ZT MP













| Névleges méret | EAN szám | Csomagolás db | | Ár áfával [HUF/db] |
|----------------|----------|---|---|--------------------|
| | |  |  | |
| 80 x 30 | 002518 | 25 | 5 200 | 510,00 |

TAKARÓSAPKA MENETES SZÁRHOZ

P-POB-HT AKG



| Névleges méret | EAN szám | Csomagolás db | | Ár áfával [HUF/db] |
|---|----------|---|---|--------------------|
| | |  |  | |
|  29 x 13 | 002280 | 50 | 16 800 | 110,00 |
|  29 x 13 | 002211 | 50 | 16 800 | 110,00 |
|  29 x 13 | 002235 | 50 | 16 800 | 110,00 |
|  29 x 13 | 002266 | 50 | 16 800 | 110,00 |
|  29 x 13 | 002242 | 50 | 16 800 | 110,00 |
|  29 x 13 | 002228 | 50 | 16 800 | 110,00 |
|  29 x 13 | 002273 | 50 | 16 800 | 110,00 |
|  29 x 13 | 002259 | 50 | 16 800 | 110,00 |
|  29 x 13 | 002297 | 50 | 16 800 | 110,00 |

ALUMINIUM W.15

MATT 3D EFFECT

ESŐLOPÓ SZÜRÖVEL

W.15-WZVS



| Névleges méret | 80 | 100 | 120 |
|---|------------------------------|------------------------------|------------------------------|
| Ár HUF/db | Áfával | Áfával | Áfával |
| ANM 1 Antracit RAL 7016 | 11 734,00 094216 | 12 885,00 094223 | 19 350,00 094230 |
| TMM 2 Barna RAL 8028 | 11 734,00 100320 | 12 885,00 100337 | 19 350,00 100344 |
| SSM 3 Egérszürke RAL 7005 | 11 734,00 100290 | 12 885,00 100306 | 19 350,00 100313 |
| ICM 4 Fekete RAL 9005 | 11 734,00 114419 | 12 885,00 114426 | 19 350,00 114433 |
| OCM 5 Bordó RAL 3009 | 11 734,00 114389 * | 12 885,00 114402 * | 19 350,00 114396 * |
| ZHM 6 Zöld-barna RAL 7013 | 11 734,00 112156 | 12 885,00 112163 | 19 350,00 112170 |
| BHM 7 Világos ezüst RAL 9006 | 11 734,00 114440 | 12 885,00 114457 | 19 350,00 114464 |
| BM 8 Fehér RAL 9010 | 11 734,00 124883 * | 12 885,00 124890 | 19 350,00 124906 * |
| ZSM 9 Cinkszürke RAL extra | 11 734,00 124975 * | 12 885,00 124982 * | 19 350,00 124999 * |
| MHM 10 Cserépszín RAL 8004 | 11 734,00 124913 * | 12 885,00 124920 * | 19 350,00 124937 * |
| MZM 11 Mohazöld RAL 6005 | 11 734,00 124944 * | 12 885,00 124951 * | 19 350,00 124968 * |
| BHTM 12 Sötét ezüst RAL 9007 | 11 734,00 124852 * | 12 885,00 124869 * | 19 350,00 124876 * |
| Csomagolás db  | 2 | 3 | 3 |
| Csomagolás db  | 240 | 90 | 90 |

* Gyártás rendelésre

ALUMINIUM W.15

MATT 3D EFFECT

ESŐLOPÓ TÖMLÖVEL

W.15-WZVHA

| Névleges méret | 80 | 120 |
|---|-----------------------|-----------------------|
| Ár HUF/db | Áfával | Áfával |
| ANM 1 Antracit RAL 7016 | 28 782,00 094186 * | 55 350,00 094209 * |
| TMM 2 Barna RAL 8028 | 28 782,00 100269 * | 55 350,00 100283 * |
| SSM 3 Egérszürke RAL 7005 | 28 782,00 100238 * | 55 350,00 100252 * |
| ICM 4 Fekete RAL 9005 | 28 782,00 116116 * | 55 350,00 116130 * |
| OCM 5 Bordó RAL 3009 | 28 782,00 116147 * | 55 350,00 116161 * |
| ZHM 6 Zöld-barna RAL 7013 | 28 782,00 112132 * | 55 350,00 112149 * |
| BHM 7 Világos ezüst RAL 9006 | 28 782,00 116086 * | 55 350,00 116109 * |
| BM 8 Fehér RAL 9010 | 28 782,00 137623 * | 55 350,00 137647 * |
| ZSM 9 Cinkszürke RAL extra | 28 782,00 137715 * | 55 350,00 137739 * |
| MHM 10 Cserépszín RAL 8004 | 28 782,00 137654 * | 55 350,00 137678 * |
| MZM 11 Mohazöld RAL 6005 | 28 782,00 137685 * | 55 350,00 137708 * |
| BHTM 12 Sötét ezüst RAL 9007 | 28 782,00 137593 * | 55 350,00 137616 * |
| Csomagolás db  | 1 | 1 |
| Csomagolás db  | 60 | 60 |



* Gyártás rendelésre



VÍZLOPÓ TÖMLŐVEL ÉS GOMBBAL

W.15-WZVHAG



| Névleges méret | 100 |
|---|------------------------------|
| Ár HUF/db | Áfával |
| ANM 1 Antracit RAL 7016 | 26 568,00 094193 |
| TMM 2 Barna RAL 8028 | 26 568,00 100276 * |
| SSM 3 Egérszürke RAL 7005 | 26 568,00 100245 * |
| ICM 4 Fekete RAL 9005 | 26 568,00 116123 * |
| OCM 5 Bordó RAL 3009 | 26 568,00 116154 * |
| ZHM 6 Zöld-barna RAL 7013 | 26 568,00 112316 * |
| BHM 7 Világos ezüst RAL 9006 | 26 568,00 116093 * |
| BM 8 Fehér RAL 9010 | 26 568,00 137630 * |
| ZSM 9 Cinkszürke RAL extra | 26 568,00 137722 * |
| MHM 10 Cserépszín RAL 8004 | 26 568,00 137661 * |
| MZM 11 Mohazöld RAL 6005 | 26 568,00 137692 * |
| BHTM 12 Sötét ezüst RAL 9007 | 26 568,00 137609 * |
| Csomagolás db  | 1 |
| Csomagolás db  | 60 |



* Gyártás rendelésre

ALUMINIUM W.15

MATT 3D EFFECT

ACÉL REVISO ÁLLVÁNYCSŐ SZÍN

W.15-WOZR

| Névleges méret | 80 | 100 | 100 |
|---|------------------------------|------------------------------|------------------------------|
| Hossz m | 1,0 | 1,0 | 1,5 |
| Ár HUF/db | Áfával | Áfával | Áfával |
| ANM 1 Antracit RAL 7016 | 29 003,00 122742 * | 22 583,00 122759 * | 46 051,00 122766 * |
| TMM 2 Barna RAL 8028 | 29 003,00 123046 * | 22 583,00 123053 * | 46 051,00 123060 * |
| SSM 3 Egérszürke RAL 7005 | 29 003,00 122995 * | 22 583,00 123008 * | 46 051,00 123015 * |
| ICM 4 Fekete RAL 9005 | 29 003,00 122797 * | 22 583,00 122803 * | 46 051,00 122810 * |
| OCM 5 Bordó RAL 3009 | 29 003,00 122841 * | 22 583,00 122858 * | 46 051,00 122865 * |
| ZHM 6 Zöld-barna RAL 7013 | 29 003,00 122940 * | 22 583,00 122957 * | 46 051,00 122964 * |
| BHM 7 Világos ezüst RAL 9006 | 29 003,00 122896 * | 22 583,00 122902 * | 46 051,00 122919 * |
| BM 8 Fehér RAL 9010 | 29 003,00 123190 * | 22 583,00 123206 * | 46 051,00 123213 * |
| ZSM 9 Cinkszürke RAL extra | 29 003,00 123145 * | 22 583,00 123152 * | 46 051,00 123169 * |
| MHM 10 Cserépszín RAL 8004 | 29 003,00 123244 * | 22 583,00 123251 * | 46 051,00 123268 * |
| MZM 11 Mohazöld RAL 6005 | 29 003,00 123091 * | 22 583,00 123107 * | 46 051,00 123114 * |
| BHTM 12 Sötét ezüst RAL 9007 | 29 003,00 123336 * | 22 583,00 123305 * | 46 051,00 123312 * |
| Csomagolás db  | 1 | 1 | 1 |
| Csomagolás db  | 70 | 60 | 60 |

* Gyártás rendelésre



ALUMINIUM W.15

MATT 3D EFFECT

ACÉL REVISO ÁLLVÁNYCSŐ SZÍN

W.15-WOZR



| Névleges méret | 120 | 120 |
|---|------------------|------------------|
| Hossz m | 1,0 | 1,5 |
| Ár HUF/db | Áfával | Áfával |
| ANM Antracit RAL 7016 | 50 656,00 | 72 309,00 |
| | 122773 * | 122780 * |
| TMM Barna RAL 8028 | 50 656,00 | 72 309,00 |
| | 123077 * | 123084 * |
| SSM Egérszürke RAL 7005 | 50 656,00 | 72 309,00 |
| | 123022 * | 123039 * |
| ICM Fekete RAL 9005 | 50 656,00 | 72 309,00 |
| | 122827 * | 122834 * |
| OCM Bordó RAL 3009 | 50 656,00 | 72 309,00 |
| | 122872 * | 122889 * |
| ZHM Zöld-barna RAL 7013 | 50 656,00 | 72 309,00 |
| | 122971 * | 122988 * |
| BHM Világos ezüst RAL 9006 | 50 656,00 | 72 309,00 |
| | 122926 * | 122933 * |
| BM Fehér RAL 9010 | 50 656,00 | 72 309,00 |
| | 123220 * | 123237 * |
| ZSM Cinkszürke RAL extra | 50 656,00 | 72 309,00 |
| | 123176 * | 123183 * |
| MHM Cserépszín RAL 8004 | 50 656,00 | 72 309,00 |
| | 123275 * | 123282 * |
| MZM Mohazöld RAL 6005 | 50 656,00 | 72 309,00 |
| | 123121 * | 123138 * |
| BHTM Sötét ezüst RAL 9007 | 50 656,00 | 72 309,00 |
| | 123329 * | 123299 * |
| Csomagolás db | 1 | 1 |
| Csomagolás db | 40 | 40 |

* Gyártás rendelésre

ALUMINIUM
W.15

GUMIS BILINCS CSAVAROS M10

P-POB-OZR



| Névleges méret | EAN szám | Csomagolás db | | Ár áfával [HUF/db] |
|----------------|----------|---------------|-------|--------------------|
| | | | | |
| 80 | 002525 | 25 | 1 250 | 690,00 |
| 100 | 002532 | 25 | 1 250 | 890,00 |
| 120 | 002549 | 20 | 1 000 | 1 000,00 |

ALUMINIUM W.15

MATT 3D EFFECT

ALUMINIUM
W.15

