



ODVODNI SISTEM POLUOKRUGLI



**CJENIK
2025**



POWERFUL PARTNER FOR YOUR ROOF

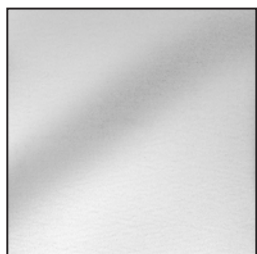

Pocink
materijal | 3



Žlijeb | 6



Dilatacija
žlijeba | 7



Žlijeb
oprema | 9



Kuka | 10



Kutnik | 13



Čelo
žlijeba | 13



Kotlić | 14



Koljeno | 18



Odvodna
cijev | 20

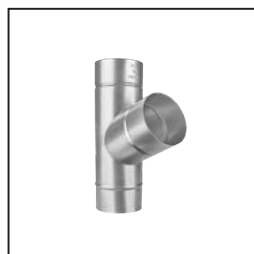

Odvodna cijev
oprema | 22



Obujmica | 23

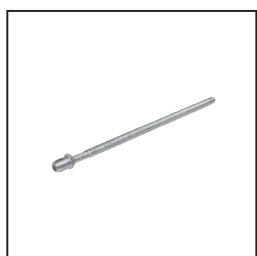

Obujmica
oprema | 24



Zadržać
vode | 28



Zaštitna
cijev | 29

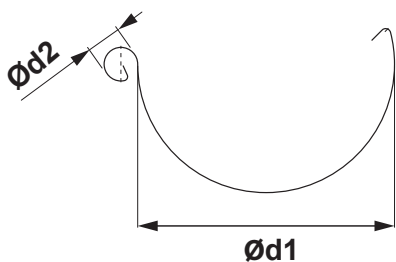

DIMENZIJE KROVNIH ŽLJEBOVA

(dimenzije i mjerne tolerancije po EN 612)

Razvijena širina (mm)	200	250	280	333	400	500
Ød1	80	105	127	153	192	250
Ød2	16	18	18	20	22	22

UNUTARNJI FALZ

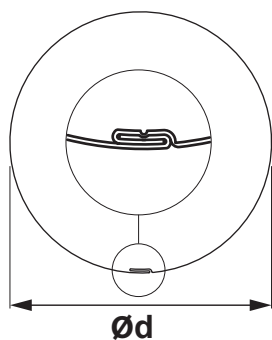

DIMENZIJE KROVNIH CIJEVI

(dimenzije i mjerne tolerancije po EN 612)

Dimenzije	60	80	100	120	150
Nazivna veličina Ød (mm)	60	80	100	120	150

DIMENZIJE KROVNIH KUKA

(dimenzije i mjerne tolerancije po EN 612)

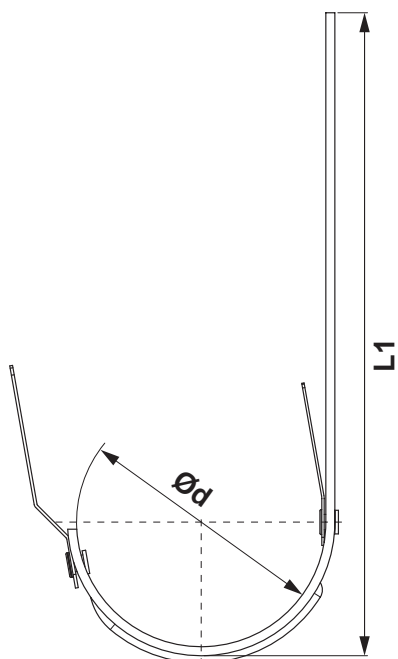

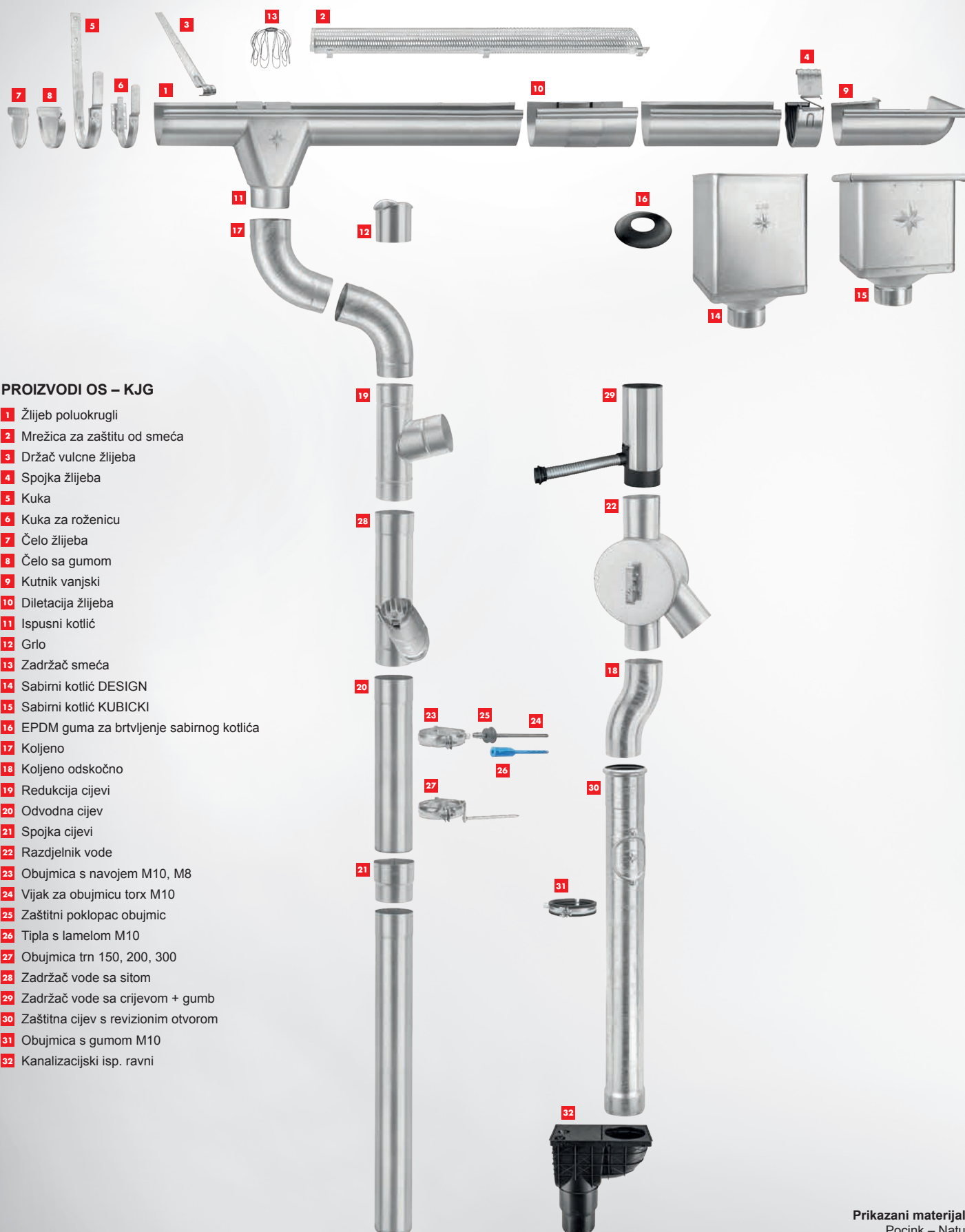

Dimenzije (mm)	L1	Ød
200	290	80
250	310	105
280	345	127
333 – 510	345	153
333 – 550	385	153
333 – 610	445	153
400	400	192



PROIZVODI OS – KJG

- 1** Žlijeb poluokrugli
- 2** Mrežica za zaštitu od smeća
- 3** Držač vulcne žlijeba
- 4** Spojka žlijeba
- 5** Kuka
- 6** Kuka za roženicu
- 7** Čelo žlijeba
- 8** Čelo sa gumom
- 9** Kutnik vanjski
- 10** Diletacija žlijeba
- 11** Ispusni kotlić
- 12** Grlu
- 13** Zadržlač smeća
- 14** Sabirni kotlić DESIGN
- 15** Sabirni kotlić KUBICKI
- 16** EPDM guma za brtvljenje sabirnog kotlića
- 17** Koljeno
- 18** Koljeno odskočno
- 19** Redukcija cijevi
- 20** Odvodna cijev
- 21** Spojka cijevi
- 22** Razdjelnik vode
- 23** Obujmica s navojem M10, M8
- 24** Vijak za obujmicu torx M10
- 25** Zaštitni poklopac obujmic
- 26** Tipla s lamelom M10
- 27** Obujmica trn 150, 200, 300
- 28** Zadržlač vode sa sitom
- 29** Zadržlač vode sa crijevom + gumb
- 30** Zaštitna cijev s revizionim otvorom
- 31** Obujmica s gumom M10
- 32** Kanalizacijski isp. ravni

Naziv materijala	RAL	Sjaj/ Mat	s = (mm)							PRIKAZANA STRUKTURA	
			0,45	0,50	0,55	0,60	0,70	0,75	0,80		1,00
● POCINČANI MATERIJAL USS	Prirodni	Mat	✓	✓	✓	✗	✗	✗	✓	✗	
● POCINČANI MATERIJAL DUN	Prirodni	Sjaj	✓	✓	✓	✓	✓	✓	✗	✓	
● POCINČANI MATERIJAL VOEST	Prirodni	Sjaj	✗	✗	✗	✓	✗	✗	✓	✗	

* Prikazana struktura može se razlikovati od prave strukture u zavisnosti od postavki zaslona ili kvalitete tiska.

U. S. Steel

U. S. Steel Košice, s.r.o. (d.o.o.) najveći je proizvođač čelika u Slovačkoj, sa svojom tradicijom više od 50 godina, i ujedno je jedno od najvećih društava u ovoj zemlji. Među njezine proizvode ubrajamo i proizvode visoke dodane vrijednosti, koji se primijenuju u automobilskoj, pakirnoj elektrotehničkoj, potrošačkoj i građevinskoj industriji.



DUNAFERR

Grupa ISD DUNAFERR sa sjedištem u Dunaújvárosu je jedan od najvećih proizvođača teške industrije u Mađarskoj. Djelatnost grupe društava, koja ima više od 6 desetljeća iskustva, je usmjerena na proizvodnju orijentiranu na kupca. Vruće valjani, luženi, hladno valjani limovi, pocinčane trake i limovi, kao i otvoreni i šuplji čelični profili proizvedeni društvom ISD DUNAFERR koriste se prije svega za proizvodnju strojarskih, automobilskih i građevinskih proizvoda.

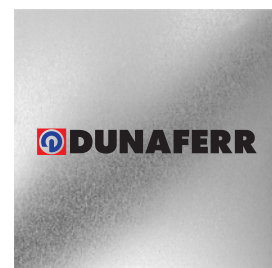

VOESTALPINE

Voestalpine sa sjedištem u Lincu, Austriji, jedan je od vodećih europskih partnera automobilske, potrošačke i energetske industrije. Pored toga je liderom na svjetskim tržištima željezničke tehnologije, alata i specijalnoga čelika. Čelik Voestalpine nalazi se u mnogim proizvodima, primjerice Airbusova najnovije generacije, građevina poput Atomiuma u Bruxellesu, stadiona Wembley u Londonu, i Burj Dubajja, najviše zgrade na svijetu. Voestalpine predstavlja 500 društava ove grupe, koju čine četiri divizije. Jedna od njih je divizija High Performance Metals, koja se fokusira na tehnološki zahtjevne proizvode u oblasti specijalnog čelika. U skladu sa specijaliziranom orijentacijom na klijenta, divizija ima globalnu prodajnu i servisnu mrežu s više od 160 filijala na svim kontinentima.

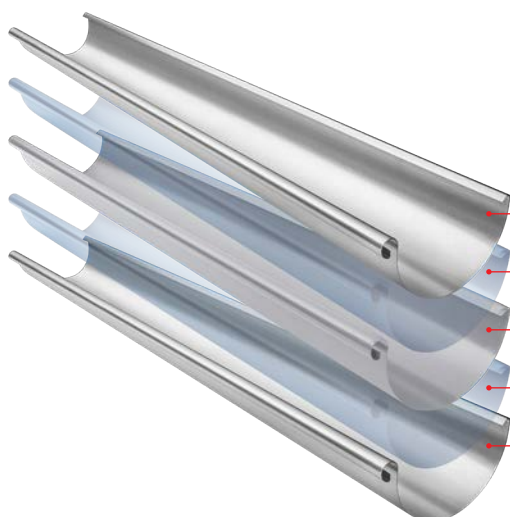

Cink-magnezijska unaprijeđena naslaga (min. 200 g/m²) za trajnu antikorozivnu zaštitu



Metalni premaz

Vlastita optimizirana čelična traka za sustav odvodnje KJG

Metalni premaz



Cink-magnezijska unaprijeđena naslaga (min. 200 g/m²) za trajnu antikorozivnu zaštitu

ŽLIJEB POLUOKRUGLI [s=0,55]
P-PZ

Nominalna veličina	Dužina u m	EAN broj narudžbe	Pakiranje u m		Cijena [€/m]	
					Bez PDV	S PDV
200	3,0	006363	15	1 200	3,30	4,13
200	4,0	006370	20	1 600	3,30	4,13
250	2,0	006394	10	480	3,30	4,13
250	3,0	006417	15	720	2,95	3,69
250	4,0	006431	20	960	2,95	3,69
250	5,0	006455	25	1200	2,95	3,69
250	6,0	006479	30	1440	2,95	3,69
280	2,0	006493	10	420	3,60	4,50
280	3,0	006516	15	630	3,30	4,13
280	4,0	006530	20	840	3,30	4,13
280	5,0	006554	25	1 050	3,30	4,13
280	6,0	006578	30	1 260	3,30	4,13
333	2,0	006592	10	330	3,70	4,63
333	3,0	006615	15	495	3,60	4,50
333	4,0	006639	20	660	3,60	4,50
333	5,0	006653	25	825	3,60	4,50
333	6,0	006677	30	990	3,60	4,50
333	7,0	006691	35	1 155	3,60	4,50
400	4,0	006707	20	540	6,55	8,19
400 *	6,0	006714	30	810	6,55	8,19
500 *	4,0	006721	20	200	10,95	13,69
500 *	6,0	020253	30	300	10,95	13,69

* Proizvodnja po narudžbi

ŽLIJEB POLUOKRUGLI [s=0,50]
P-PZ

Nominalna veličina	Dužina u m	EAN broj narudžbe	Pakiranje u m		Cijena [€/m]	
					Bez PDV	S PDV
333	4,0	006622	20	660	3,40	4,25
333	5,0	006646	25	825	3,40	4,25
333	6,0	006660	30	990	3,40	4,25
333	7,0	006684	35	1 155	3,40	4,25



ŽLIJEB NATKROVNI [s=0,55]

P-PZS



Nominalna veličina	Dužina u m	EAN broj narudžbe	Pakiranje u m		Cijena [€/m]	
					Bez PDV	S PDV
650 *	4,0	023889	4	200	8,75	10,94
650	6,0	023896	6	300	8,75	10,94
800 *	4,0	023902	4	160	10,15	12,69

* Proizvodnja po narudžbi

DILETACIJA ŽLIJEB A

P-PZDI



Nominalna veličina	EAN broj narudžbe	Pakiranje u kom		Cijena [€/kom]	
				Bez PDV	S PDV
250/260 *	080509	3	360	10,90	13,63
280/260 *	080493	3	360	11,00	13,75
333/260 *	080486	5	200	11,40	14,25
400/260 *	080479	5	200	15,00	18,75

* Proizvodnja po narudžbi

DILETACIJA ZA LEŽEĆI ŽLIJEB

P-PZSDI



Nominalna veličina	EAN broj narudžbe	Pakiranje u kom		Cijena [€/kom]	
				Bez PDV	S PDV
670/260 *	080462	1	40	25,80	32,25

* Proizvodnja po narudžbi

DILETACIJSKA TRAKA

P-PZDIP



Nominalna veličina	Dužina u m	EAN broj narudžbe	Pakiranje u m		Cijena [€/m]	
					Bez PDV	S PDV
260	3,0	012470	3	120	33,60	42,00
260 *	6,0	012487	6	240	33,60	42,00

KORIŠTENJE SPOJKE ŽLIJEBA I SPOJNE TRAKE

SPOJKA ŽLIJEBA

Primjer montaže: Podkorvni žlijeb razvijene širine do 500 mm. Spojka žlijeba mora biti montirana u međusobnoj udaljenosti 15 m. Za vanjski kutnik i početak žlijeba važi polovica standardne vrijednosti: maksimalno 7,5 m. Za unutarnji kutnik važi četvrtina standardne vrijednosti: maksimalno 3,75 m. Za ostale materijale i dimenzije: vidi tabelica dolje. Kutnici se uvijek smatraju čvrstim točkama.

KROVNI POLUOKRUGLI ŽLJEBOVI

Razvijena širina žlijeba	Aluminij	Pocink, Cinkotit, Bakar, Inox
< 500	12	15
> 500	8	10

SPAJANJE TRAKOM

Unutarnja instalacija: za četvrtaste žljebove pričvršćene za podlogu bez lijepljenja, za krovove s nestandardnim profilom, i oplatu zida limom

KROVNO SPAJANJE TRAKOM

Razvijena širina žlijeba	Aluminij	Pocink, Cinkotit, Bakar, Inox
< 500	8	10
> 500	6	8

Za vanjski kutnik ili početak žlijeba važi polovica standardne vrijednosti. Za unutarnji kutnik važi četvrtina standardne vrijednosti.

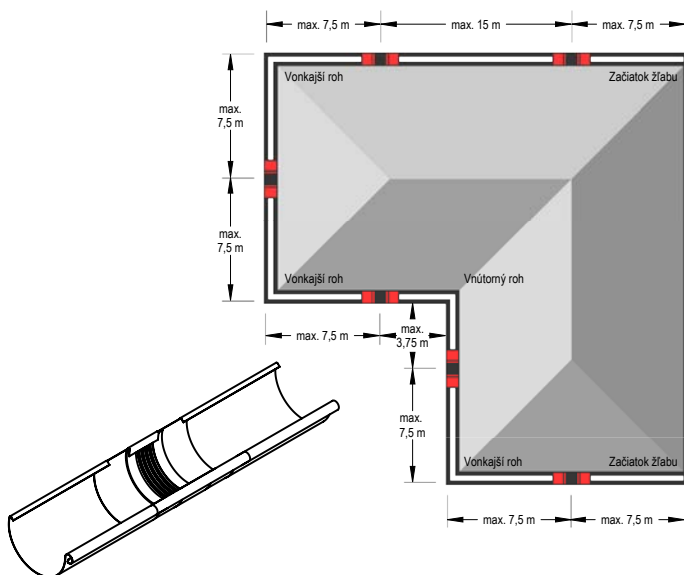

Napomena uz montažu spojne trake.

Za vrijeme montaže uz pomoć mekog lemljenja prvo pokrite dio mokrom krpom (kako ne bi došlo do prelaska topline u središnji gumeni dio). Mora se održavati minimalna udaljenost 6 cm od središnjeg gumenog dijela. U svakom slučaju treba izbjegavati kontakt gume s plamenom.

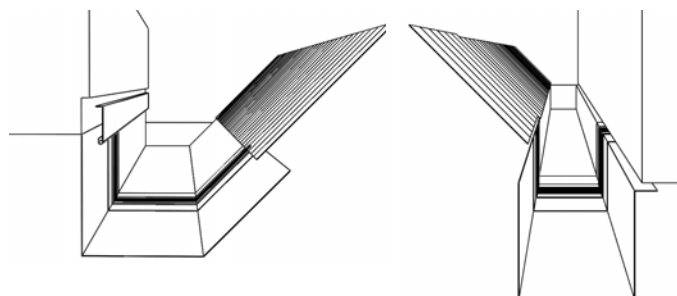

Napomena uz montažu spojne trake.

Kada se savija i montira spojna traka, provjerite sljedeće:

- Klijesta za savijanje imaju radijus minimalno 2 mm.
- Za debljinu lima 1 mm se mora održati polumjer savijanja minimalno 5 mm.
- Klijesta za savijanje moraju za vrijeme savijanja biti podešena za debljinu 3 do 4 mm, kako bi se spriječio efekt sječenja – oštećenja gume.
- Središnji gumeni dio za vrijeme savijanja ne smije biti pritisnut ili oštećen. Treba zbog toga koristiti aluminijsku limenu traku debljine 2 do 5 mm, i saviti je tako, da se može pričvrstiti kao zaštita za klijesta za savijanje. Time ćemo dobiti veći polumjer savijanja, i spriječiti da se ošteti središnji gumeni dio.



ALUMINIJSKA MREŽICA ZA ZAŠTITU OD SMEČA

W-WZNLM

Nominalna veličina	Dužina u m	EAN broj narudžbe	Pakiranje u kom		Cijena [€/kom]	
					Bez PDV	S PDV
333	2,0	064905	25	300	25,50	31,88

PVC ŽLIJEBNI ZADRŽAČ SMEČA

SD-ZNL MREZKA

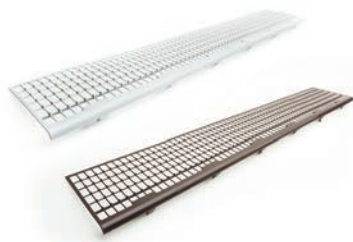

Nominalna veličina	Dužina u m	EAN broj narudžbe	Pakiranje u kom		Cijena [€/kom]	
					Bez PDV	S PDV
171	1,0	008473	30	450	4,50	5,63
171	1,0	008466	30	450	4,50	5,63

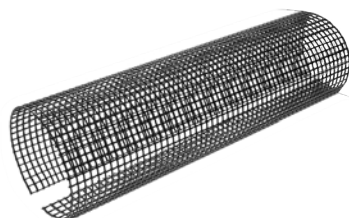

PVC ŽLIJEBNI ZADRŽAČ SMEČA

SD-ZNL N

Nominalna veličina	Dužina u m	EAN broj narudžbe	Pakiranje u kom		Cijena [€/kom]	
					Bez PDV	S PDV
250 *	3,0	008480	10	400	23,90	29,88
280-333 *	3,0	008497	10	400	24,00	30,00

* Proizvodnja po narudžbi



DRŽAČ VULCNE ŽLIJEBA

P-PDZNV



Nominalna veličina	EAN broj narudžbe	Pakiranje u kom		Cijena [€/kom]	
				Bez PDV	S PDV
18/250, 280 *	085269	25	3 000	0,95	1,19
20/333 *	085276	25	3 000	0,95	1,19
22/400 *	085283	25	3 000	0,95	1,19

* Proizvodnja po narudžbi

SPOJKA ŽLIJEBA

P-PSPZ



Nominalna veličina	EAN broj narudžbe	Pakiranje u kom		Cijena [€/kom]	
				Bez PDV	S PDV
250	083418	5	600	2,70	3,38
280	083425	5	600	2,70	3,38
333	083432	5	600	2,80	3,50

KUKA ZA NATKROVNI ŽLIJEB



P-PHSSN



Nominalna veličina	Materijal	EAN broj narudžbe	Pakiranje u kom		Cijena [€/kom]	
					Bez PDV	S PDV
4	20/6	033444	25	1 000	5,10	6,38

KUKA

P-PHP

Nominalna veličina	Materijal	EAN broj narudžbe	Pakiranje u kom		Cijena [€/kom]	
					Bez PDV	S PDV
200/380	25/4	032904	10	1 000	1,60	2,00
250/380 *	25/5	032911	10	1 000	1,65	2,06
250/430 *	25/4	033420	10	2 000	1,75	2,19
250/430	25/5	032928	10	1 000	1,70	2,13
250/480 *	25/5	032935	10	1 000	1,85	2,31
280/430 *	25/5	032942	10	2 000	1,75	2,19
280/430 *	30/5	032959	10	2 000	1,95	2,44
280/480	25/5	032966	10	2 000	1,85	2,31
280/480 *	30/4	032973	10	1 500	1,95	2,44
280/480 *	30/5	032980	10	1 000	2,15	2,69
280/530 *	25/5	032997	10	1 000	2,05	2,56
280/530 *	30/5	033000	10	1 500	2,30	2,88
333/480 *	25/5	033017	10	2 000	1,85	2,31
333/480 *	30/4	080769	10	1 500	1,95	2,44
333/480 *	30/5	033024	10	2 000	2,15	2,69
333/510	25/5	033031	10	2 000	2,00	2,50
333/510 *	30/4	033048	10	1 500	2,00	2,50
333/510 *	30/5	033055	10	1 500	2,15	2,69
333/550	25/5	033062	10	2 000	2,05	2,56
333/550	30/4	033079	10	1 500	2,10	2,63
333/550	30/5	033086	10	1 500	2,10	2,63
333/610	25/5	033093	10	1 000	2,30	2,88
333/610 *	30/5	033109	10	1 000	2,70	3,38
400/610 *	30/5	033437	10	1 000	2,95	3,69
400/610	30/6	033116	10	1 000	3,30	4,13
400/650	30/6	033123	10	1 000	3,50	4,38

* Proizvodnja po narudžbi



KUKA ZA ROŽENICU

P-PHPK



Nominalna veličina	Materijal	EAN broj narudžbe	Pakiranje u kom		Cijena [€/kom]	
					Bez PDV	S PDV
200	25/4	065001	25	1 000	2,30	2,88
250	25/4	065018	25	1 000	2,15	2,69
280	25/4	065025	25	1 000	2,25	2,81
333	25/5	065032	25	1 000	2,35	2,94
400	30/5	065049	20	800	3,70	4,63

KUKA ZA ROŽENICU S NOSOM

P-PHPNK



Nominalna veličina	Materijal	EAN broj narudžbe	Pakiranje u kom		Cijena [€/kom]	
					Bez PDV	S PDV
250 *	25/4	095282	25	1 000	3,10	3,88
280 *	25/4	095299	25	1 000	3,15	3,94
333 *	25/5	095305	25	1 000	3,20	4,00

* Proizvodnja po narudžbi

KUKA S NOSOM

P-PHPN



Nominalna veličina	Materijal	EAN broj narudžbe	Pakiranje u kom		Cijena [€/kom]	
					Bez PDV	S PDV
250/430 *	25/5	095787	10	1 000	1,95	2,44
280/480 *	25/5	095794	10	1 000	2,20	2,75
333/550 *	25/5	095800	10	1 000	2,40	3,00
400/610 *	30/5	095817	10	1 000	3,80	4,75

* Proizvodnja po narudžbi

KUTNIK VANJSKI VOEST

P-PRA/VOEST



Nominalna veličina	EAN broj narudžbe	Pakiranje u kom		Cijena [€/kom]	
				Bez PDV	S PDV
250	000958	5	150	6,40	8,00
280	000965	5	150	6,50	8,13
333	000972	5	150	6,70	8,38

KUTNIK UNUTARNJI VOEST

P-PRI/VOEST



Nominalna veličina	EAN broj narudžbe	Pakiranje u kom		Cijena [€/kom]	
				Bez PDV	S PDV
250	000927	5	150	6,40	8,00
280	000934	5	150	6,50	8,13
333	000941	5	150	6,70	8,38

ČELO ŽLIJEBA

P-PCL/DUN



Nominalna veličina	EAN broj narudžbe	Pakiranje u kom		Cijena [€/kom]	
				Bez PDV	S PDV
200	002617	6/60	1 440	0,49	0,61
250	002624	50	4 500	0,40	0,50
280	002631	50	4 500	0,45	0,56
333	002648	50	4 500	0,49	0,61
400	002655	4/40	960	1,20	1,50

ČELO SA GUMOM

P-PCLG/DUN



Nominalna veličina	EAN broj narudžbe	Pakiranje u kom		Cijena [€/kom]	
				Bez PDV	S PDV
250	096692	25	2 250	0,95	1,19
280	096708	25	2 250	1,10	1,38
333	096715	25	2 250	1,20	1,50

ISPUSNI KOTLIĆ

P-PKL



Nominalna veličina	EAN broj narudžbe	Pakiranje u kom		Cijena [€/kom]	
				Bez PDV	S PDV
250/60	067579	20	600	5,95	7,44
250/80	006134	20	600	3,60	4,50
280/80	006141	20	600	4,10	5,13
280/100	006158	20	600	4,25	5,31
333/80	006165	20	600	4,70	5,88
333/100	006172	20	600	4,45	5,56
333/120	006196	15	300	5,30	6,63
400/120	006202	15	300	9,00	11,25
400/150	066244	15	300	9,50	11,88

POCINK
NATUR

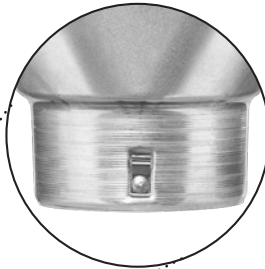

NOVI PRIČVRSNSI
SISTEM FEDER OMOGUĆUJE
LAGANO OKRETANJE KOLJENA
DO TRAŽENOG SMJERA
TE JE POUZDANO U SVAKOJ
POZICIJI. LAGANA MONTAŽA NA
BILO KAKVO KOLJENO
BEZ NITANJA.



GRLO

P-PHRD/DUN





Nominalna veličina	EAN broj narudžbe	Pakiranje u kom		Cijena [€/kom]	
				Bez PDV	S PDV
80 *	065681	25	1 000	1,05	1,31
100	065698	25	1 000	1,10	1,38
120 *	065704	15	750	1,35	1,69

* Proizvodnja po narudžbi

ZADRŽAČ SMEĆA

P-PZN





Nominalna veličina	EAN broj narudžbe	Pakiranje u kom		Cijena [€/kom]	
				Bez PDV	S PDV
60	001047	30	2 160	5,55	6,94
80	001054	20	1 440	5,60	7,00
100	001061	15	1 080	5,70	7,13
120	001078	10	720	6,20	7,75
150 *	001085	5	360	9,80	12,25

* Proizvodnja po narudžbi

SABIRNI KOTLIĆ CENTRALNI

IT-KLZF C





Nominalna veličina	EAN broj narudžbe	Pakiranje u kom		Cijena [€/kom]	
				Bez PDV	S PDV
60	076465	10	300	13,80	17,25
80	076489	10	300	13,90	17,38
100	076502	10	200	15,20	19,00
120	076526	10	200	20,20	25,25

SABIRNI KOTLIĆ BOČNI

IT-KLZF B



Nominalna veličina	EAN broj narudžbe	Pakiranje u kom		Cijena [€/kom]	
				Bez PDV	S PDV
60	076458	10	300	13,80	17,25
80	076472	10	300	13,90	17,38
100	076496	10	200	15,20	19,00
120	076519	10	200	20,20	25,25



SABIRNI KOTLIĆ DESIGN

P-PKLZ DE

Nominalna veličina	EAN broj narudžbe	Pakiranje u kom		Cijena [€/kom]	
				Bez PDV	S PDV
80	007681	2	36	45,00	56,25
100	007704	2	36	45,00	56,25
120 *	007728	2	36	46,00	57,50

* Proizvodnja po narudžbi



SABIRNI KOTLIĆ DESIGN EKSCENTRIČNI

P-PKLZ DX

Nominalna veličina	EAN broj narudžbe	Pakiranje u kom		Cijena [€/kom]	
				Bez PDV	S PDV
80	007742	2	36	58,50	73,13
100	007773	2	36	58,50	73,13
120 *	007803	2	36	59,50	74,38

* Proizvodnja po narudžbi

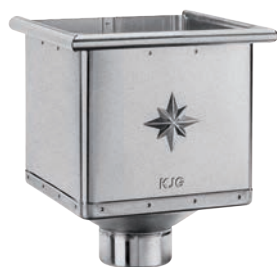

SABIRNI KOTLIĆ KUBICKI

P-PKLZ KU

Nominalna veličina	EAN broj narudžbe	Pakiranje u kom		Cijena [€/kom]	
				Bez PDV	S PDV
80 *	007698	2	36	77,00	96,25
100 *	007711	2	36	77,00	96,25
120 *	007735	2	36	78,00	97,50

* Proizvodnja po narudžbi



SABIRNI KOTLIĆ KUBICKI EKSCENTRIČAN

P-PKLZ KX

Nominalna veličina	EAN broj narudžbe	Pakiranje u kom		Cijena [€/kom]	
				Bez PDV	S PDV
80	007759	2	36	77,00	96,25
100	007780	2	36	77,00	96,25
120 *	007810	2	36	78,00	97,50

* Proizvodnja po narudžbi



SABIRNI KOTLIĆ KUBICKI EKSCENTRIČNI S OTVOROM

P-PKLZ KXV

Nominalna veličina	EAN broj narudžbe	Pakiranje u kom		Cijena [€/kom]	
				Bez PDV	S PDV
80 *	007766	2	36	103,00	128,75
100 *	007797	2	36	103,00	128,75
120 *	007827	2	36	103,00	128,75

* Proizvodnja po narudžbi

GUMA ZA BRTVLJENJE SABIRNOG KOTLIĆA

P-PKLZ T



Nominalna veličina	EAN broj narudžbe	Pakiranje u kom		Cijena [€/kom]	
				Bez PDV	S PDV
IC 70-85 *	077103	5	600	4,00	5,00
IC 100-110	077110	5	600	4,10	5,13
IC 110-125 *	077097	5	600	4,20	5,25
PS 70-85 *	077134	5	600	4,50	5,63
PS 100-110	077141	5	600	4,90	6,13
PS 110-125 *	077127	5	600	5,00	6,25

* Proizvodnja po narudžbi

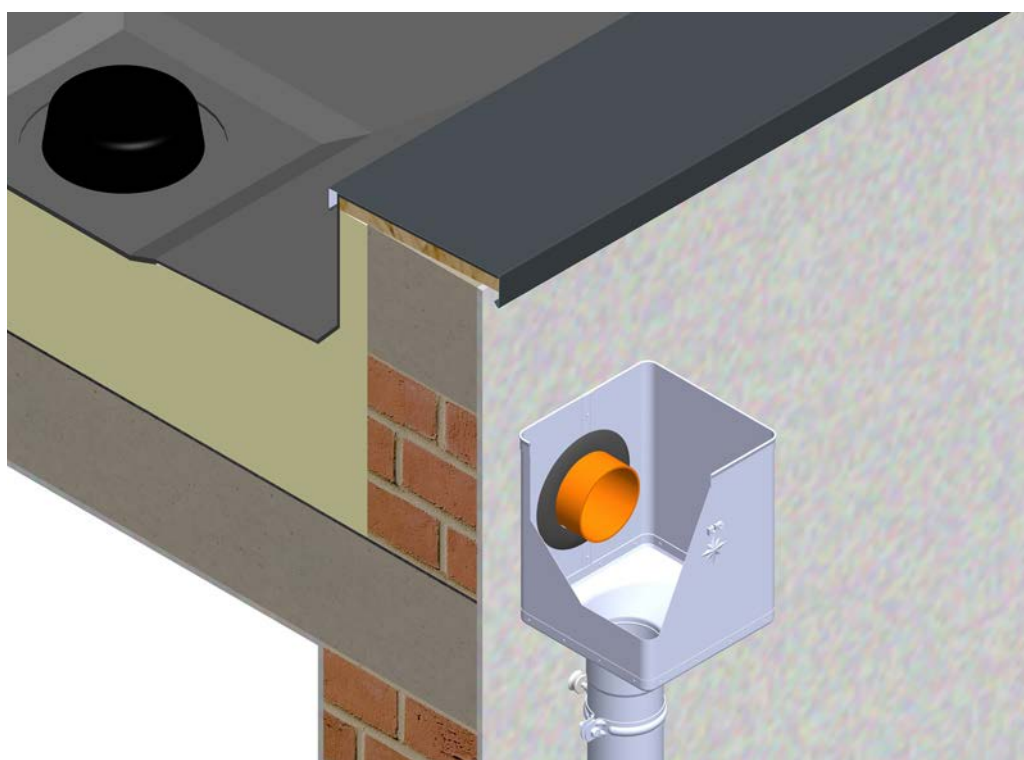

KOLJENO 72°

P-PKZS



Nominalna veličina	EAN broj narudžbe	Pakiranje u kom		Cijena [€/kom]	
				Bez PDV	S PDV
60	034236	25	600	3,15	3,94
80	034243	25	400	3,10	3,88
100	034267	25	300	3,45	4,31
120	034281	15	180	4,70	5,88
150	033581	5	90	11,00	13,75

KOLJENO 85°

P-PKRZS



Nominalna veličina	EAN broj narudžbe	Pakiranje u kom		Cijena [€/kom]	
				Bez PDV	S PDV
80	034250	25	400	3,40	4,25
100	034274	25	300	3,90	4,88
120	034298	15	180	5,70	7,13

KOLJENO 40°

P-PKTZS



Nominalna veličina	EAN broj narudžbe	Pakiranje u kom		Cijena [€/kom]	
				Bez PDV	S PDV
80	034359	25	400	3,20	4,00
100	034366	25	300	3,35	4,19
120	034373	15	240	5,90	7,38

KOLJENO FALZANO 72°

P-PKF2



Nominalna veličina	EAN broj narudžbe	Pakiranje u kom		Cijena [€/kom]	
				Bez PDV	S PDV
60	071729	10	3 000	2,15	2,69
80	071736	10	1 680	1,90	2,38
100	071750	10	1 000	2,20	2,75
120	071767	8	576	3,70	4,63

KOLJENO FALZANO 85°



P-PKF3



Nominalna veličina	EAN broj narudžbe	Pakiranje u kom		Cijena [€/kom]	
				Bez PDV	S PDV
80	071743	10	1 680	2,40	3,00
100	071774	10	1 000	2,90	3,63

ODVODNA CIJEV [s=0,55]

P-PZR

Nominalna veličina	Dužina u m	EAN broj narudžbe	Pakiranje u m		Cijena [€/m]	
					Bez PDV	S PDV
60	2,0	006738	10	490	3,65	4,56
60	3,0	006745	15	735	3,65	4,56
80	1,0	006769	10	100	3,45	4,31
80	2,0	006783	10	250	3,45	4,31
80	3,0	006806	15	375	3,30	4,13
80	4,0	006820	20	500	3,30	4,13
80	5,0	006844	5	625	3,30	4,13
80	6,0	006868	6	750	3,30	4,13
100	1,0	006882	10	70	3,70	4,63
100	2,0	006905	10	160	3,70	4,63
100	3,0	006929	15	240	3,60	4,50
100	4,0	006943	20	320	3,60	4,50
100	5,0	006967	5	400	3,60	4,50
100	6,0	006981	6	480	3,60	4,50
120 *	1,0	007001	8	48	5,00	6,25
120	2,0	007025	10	120	5,00	6,25
120	3,0	007049	15	180	4,90	6,13
120	4,0	007063	20	240	4,90	6,13
120 *	5,0	007087	5	300	4,90	6,13
120	6,0	007100	6	360	4,90	6,13
150 *	3,0	007117	3	84	8,45	10,56
150	4,0	007124	4	112	8,45	10,56

* Proizvodnja po narudžbi





ODVODNA CIJEV [s=0,50]

P-PZR

Nominalna veličina	Dužina u m	EAN broj narudžbe	Pakiranje u m		Cijena [€/m]	
					Bez PDV	S PDV
100	3,0	006912	15	240	3,40	4,25
100	4,0	006936	20	320	3,40	4,25
100	5,0	006950	5	400	3,40	4,25
100	6,0	006974	6	480	3,40	4,25



PVC IZLJEVNI RUKAV

SD-ZR FOLIA KJG

Nominalna veličina	Dužina u m	EAN broj narudžbe	Pakiranje u m		Cijena [€/m]	
					Bez PDV	S PDV
60-150	100,0	139726	100	6 000	0,38	0,48

SPOJKA CIJEVI

P-PSRU



Nominalna veličina	EAN broj narudžbe	Pakiranje u kom		Cijena [€/kom]	
				Bez PDV	S PDV
80	017253	10	900	3,30	4,13
100	017260	10	900	3,45	4,31
120	017277	8	720	3,70	4,63

KOLJENO ODSKOČNO

P-PKO



Nominalna veličina	EAN broj narudžbe	Pakiranje u kom		Cijena [€/kom]	
				Bez PDV	S PDV
80	033710	20	320	6,40	8,00
100	033727	20	240	6,90	8,63
120	033734	15	180	10,50	13,13

REDUKCIJA CIJEVI 72°

P-PZO/DUN



Nominalna veličina	EAN broj narudžbe	Pakiranje u kom		Cijena [€/kom]	
				Bez PDV	S PDV
80/80 *	067777	4	120	14,00	17,50
100/60 *	067784	4	120	14,20	17,75
100/80	067791	4	120	14,40	18,00
100/100	067807	4	120	14,40	18,00
120/80 *	067814	3	90	14,90	18,63
120/100	067821	3	90	14,90	18,63
120/120 *	067838	3	90	14,90	18,63
150/120 *	067845	2	36	19,20	24,00
150/150 *	067852	2	36	19,20	24,00

* Proizvodnja po narudžbi

RAZDJELNIK VODE

P-PRV



Nominalna veličina	EAN broj narudžbe	Pakiranje u kom		Cijena [€/kom]	
				Bez PDV	S PDV
80 *	088086	1	–	168,00	210,00
100	088093	1	–	170,00	212,50
120 *	088109	1	–	225,00	281,25

* Proizvodnja po narudžbi

OBUJMICA TRN 150 mm

P-PO



Nominalna veličina	EAN broj narudžbe	Pakiranje u kom		Cijena [€/kom]	
				Bez PDV	S PDV
80	001719	25	1 000	1,75	2,19
100	001726	25	1 000	1,80	2,25
120	001733	25	1 000	1,95	2,44

OBUJMICA TRN 200 mm

P-POD



Nominalna veličina	EAN broj narudžbe	Pakiranje u kom		Cijena [€/kom]	
				Bez PDV	S PDV
80	001740	25	1 000	1,90	2,38
100	001757	25	1 000	1,95	2,44
120	001764	25	1 000	2,05	2,56

OBUJMICA TRN 300 mm

P-PODD



Nominalna veličina	EAN broj narudžbe	Pakiranje u kom		Cijena [€/kom]	
				Bez PDV	S PDV
100	001788	20	800	2,15	2,69
120	001795	20	800	2,30	2,88

OBUJMICA S NAVOJEM M10

P-POB



Nominalna veličina	EAN broj narudžbe	Pakiranje u kom		Cijena [€/kom]	
				Bez PDV	S PDV
60	002167	25	3 000	1,80	2,25
80	002174	25	3 000	1,40	1,75
100	002181	25	3 000	1,45	1,81
120	002198	25	3 000	1,65	2,06
150	002204	20	2 400	2,95	3,69

OBUJMICA S NAVOJEM M8

P-POB



Nominalna veličina	EAN broj narudžbe	Pakiranje u kom		Cijena [€/kom]	
				Bez PDV	S PDV
60	073372	25	3 000	1,80	2,25
80	073389	25	3 000	1,40	1,75
100	073396	25	3 000	1,45	1,81
120	073402	25	3 000	1,65	2,06
150	073419	20	2 400	2,95	3,69

INOX VIJAK ZA OBUJMICU M6x20

P-POB-NSK



Nominalna veličina	EAN broj narudžbe	Pakiranje u kom		Cijena [€/kom]	
				Bez PDV	S PDV
M6 x 20 *	071675	1	–	0,15	0,19

* Proizvodnja po narudžbi

VIJAK ZA OBUJMICU TORX M10

P-POB-HT



Nominalna veličina	EAN broj narudžbe	Pakiranje u kom		Cijena [€/kom]	
				Bez PDV	S PDV
80	002464	100	40 000	1,00	1,25
140	002471	100	28 000	1,25	1,56
200	002488	100	20 000	1,55	1,94
250	002495	100	16 000	1,70	2,13
300	002501	100	11 200	1,70	2,13

TIPLA M10

P-POB-HN DB



Nominalna veličina	EAN broj narudžbe	Pakiranje u kom		Cijena [€/kom]	
				Bez PDV	S PDV
120	002426	100	25 000	0,40	0,50

TIPLA S LAMELOM M10

P-POB-HN DB





Nominalna veličina	EAN broj narudžbe	Pakiranje u kom		Cijena [€/kom]	
				Bez PDV	S PDV
180	002433	100	12 000	0,42	0,53
240	002440	100	12 000	0,50	0,63
280	002457	100	12 000	0,53	0,66

KOMBINIRANI VIJAK TORX M10

P-POB-ZT/SZ





Nominalna veličina	EAN broj narudžbe	Pakiranje u kom		Cijena [€/kom]	
				Bez PDV	S PDV
140	002587	50	10 400	0,45	0,56
180	002594	50	10 400	0,55	0,69

TIPLA KVADRATNA ŠPICA 7x7

P-POB-HN R1





Nominalna veličina	EAN broj narudžbe	Pakiranje u kom		Cijena [€/kom]	
				Bez PDV	S PDV
200/60	002600	250	15 000	0,17	0,21

TIPLA ZA IZOLACIJU M10

P-POB-HN IZOL





Nominalna veličina	EAN broj narudžbe	Pakiranje u kom		Cijena [€/kom]	
				Bez PDV	S PDV
M10 x 96	001207	25	2 625	2,70	3,38

KLIN SA PVC TIPLOM ZA OPEKU BEZ IZOLACIJE

P-POB-HN WDV5140 M10





Nominalna veličina	EAN broj narudžbe	Pakiranje u kom		Cijena [€/kom]	
				Bez PDV	S PDV
140	144843	1/5	750	4,80	6,00

KLIN SA PVC TIPLOM ZA OPEKU SA IZOLACIJOM

P-POB-HN WDV5300 M10





Nominalna veličina	EAN broj narudžbe	Pakiranje u kom		Cijena [€/kom]	
				Bez PDV	S PDV
300	144850	1/5	500	7,80	9,75

UNI NASTAVAK OD NEHRĐAJUČEG ČELIKA ZA PRIČVRŠČIVANJE OB M10

P-POB-HN PLAT M10





Nominalna veličina	EAN broj narudžbe	Pakiranje u kom		Cijena [€/kom]	
				Bez PDV	S PDV
M10	144836	25/500	5 000	3,35	4,19

NAVOJNA ŠIPKA M10

P-POB-ZT





Nominalna veličina	EAN broj narudžbe	Pakiranje u kom		Cijena [€/kom]	
				Bez PDV	S PDV
60	002556	100	20 800	0,20	0,25
100	002563	100	15 600	0,30	0,38
150	002570	50	10 400	0,55	0,69

MONTAŽNA PLOČICA M10

P-POB-ZT MP





Nominalna veličina	EAN broj narudžbe	Pakiranje u kom		Cijena [€/kom]	
				Bez PDV	S PDV
80 x 30	002518	25	5 200	1,15	1,44

VIJAK ZA OBUJMICU M8

P-POB-HB





Nominalna veličina	EAN broj narudžbe	Pakiranje u kom		Cijena [€/kom]	
				Bez PDV	S PDV
150	071590	100	5 000	0,65	0,81
200	071606	100	5 000	0,92	1,15
250	071613	100	5 000	1,05	1,31
300	071620	100	5 000	1,10	1,38

TIPLA M8

P-POB-HBN-SS



Nominalna veličina	EAN broj narudžbe	Pakiranje u kom		Cijena [€/kom]	
				Bez PDV	S PDV
150	071637	100	5 000	0,25	0,31
200	071644	100	5 000	0,26	0,33
250	071651	100	5 000	0,35	0,44
300	071668	100	8 000	0,37	0,46

ZAŠTITNI POKLOPAC OBUJMIC

P-POB-HT AKG



Nominalna veličina	EAN broj narudžbe	Pakiranje u kom		Cijena [€/kom]	
				Bez PDV	S PDV
TM 29 x 13	002280	50	16 800	0,25	0,31
AN 29 x 13	002211	50	16 800	0,25	0,31
IC 29 x 13	002235	50	16 800	0,25	0,31
OC 29 x 13	002266	50	16 800	0,25	0,31
MH 29 x 13	002242	50	16 800	0,25	0,31
B SB 29 x 13	002228	50	16 800	0,25	0,31
PS BH BHT 29 x 13	002273	50	16 800	0,25	0,31
MZ 29 x 13	002259	50	16 800	0,25	0,31
ZH 29 x 13	002297	50	16 800	0,25	0,31





ZADRŽAČ VODE

P-PZV/DUN

Nominalna veličina	EAN broj narudžbe	Pakiranje u kom		Cijena [€/kom]	
				Bez PDV	S PDV
80	006097	6	180	6,95	8,69
100	006103	5	150	7,75	9,69



ZADRŽAČ VODE SA SITOM

P-PZVS/DUN

Nominalna veličina	EAN broj narudžbe	Pakiranje u kom		Cijena [€/kom]	
				Bez PDV	S PDV
80	006066	6	180	8,95	11,19
100	006073	5	150	9,95	12,44
120	006080	3	90	15,90	19,88



ALUMINIJSKI ZADRŽAČ VODE SA CRIJEVOM

W-WZVHA

Nominalna veličina	EAN broj narudžbe	Pakiranje u kom		Cijena [€/kom]	
				Bez PDV	S PDV
80	001481	1	60	58,50	73,13
120	001504	1	60	112,50	140,63



ALUMINIJSKI ZADRŽAČ VODE SA CRIJEVOM + GUMB

W-WZVHAG

Nominalna veličina	EAN broj narudžbe	Pakiranje u kom		Cijena [€/kom]	
				Bez PDV	S PDV
100	001498	1	60	58,50	73,13



ZAŠTITNA CIJEV S REVIZIONIM OTVOROM

P-POZR

Nominalna veličina	Dužina u m	EAN broj narudžbe	Pakiranje u kom		Cijena [€/kom]	
					Bez PDV	S PDV
80 *	1,0	009708	1	70	60,00	75,00
100	1,0	009715	1	60	45,00	56,25
100	1,5	009722	1	60	89,00	111,25

* Proizvodnja po narudžbi



ZAŠTITNA CIJEV S REVIZIONIM OTVOROM

P-POZR

Nominalna veličina	Dužina u m	EAN broj narudžbe	Pakiranje u kom		Cijena [€/kom]	
					Bez PDV	S PDV
120 *	1,0	009739	1	40	105,00	131,25
120 *	1,5	009746	1	40	143,00	178,75

* Proizvodnja po narudžbi



OBUJMICA S GUMOM M10

P-POB-OZR

Nominalna veličina	EAN broj narudžbe	Pakiranje u kom		Cijena [€/kom]	
				Bez PDV	S PDV
80	002525	25	1 250	1,55	1,94
100	002532	25	1 250	2,00	2,50
120	002549	20	1 000	2,25	2,81

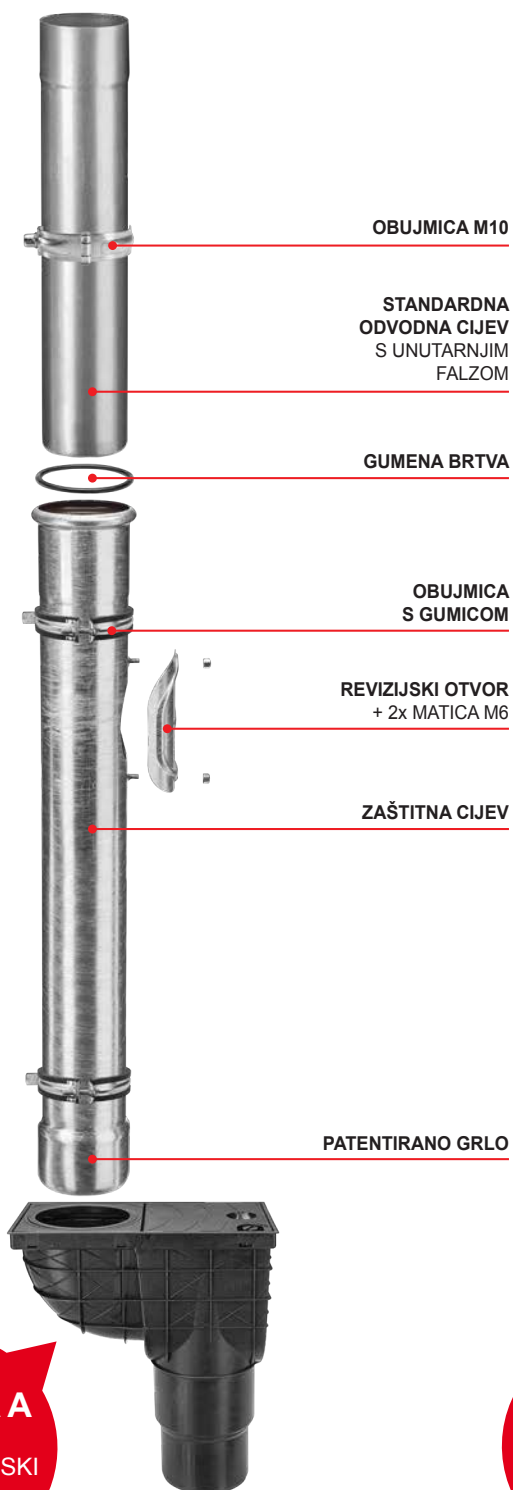

VERZIJA A
PVC
KANALIZACIJSKI
ISPUST

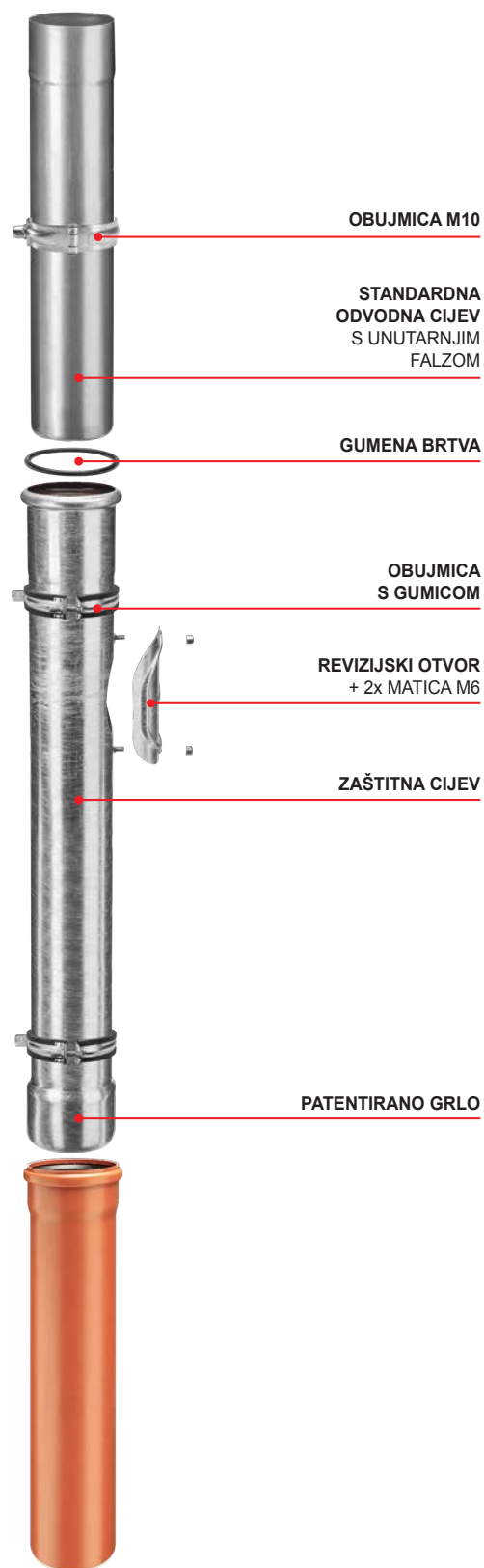

VERZIJA B
PVC
KANALIZACIJSKA
CIJEV

