



POCIN
KANO

BAR
VANO

ŽLEBNI SISTEM POLKROŽNI



CENIK
2024

PRIPOROČENA PRODAJNA CENA



POWERFUL PARTNER FOR YOUR ROOF



Pocinkano material | 3



Žleb | 6



Strešni diletacijski žleb | 14



Žleb oprema | 17



Kljuka | 21



Vogalnik | 26



Zaključek žleba | 28



Kotliček | 30



Koleno | 44



Cev odvodna | 49



Cev odvodna oprema | 58



Objemka | 61

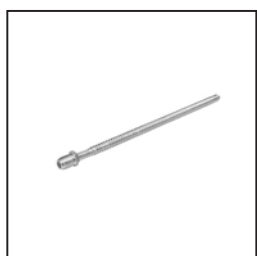

Objemka oprema | 65



Lovilec vode | 68



Zaščitna cev | 72

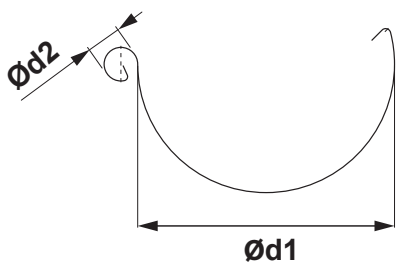

DIMENZIJE STREŠNIH ŽLEBOV

(dimenzije in toleranca po EN 612)

Razvita širina (mm)	200	250	280	333	400	500
Ød1	80	105	127	153	192	250
Ød2	16	18	18	20	22	22

NOTRANJI ZGIB

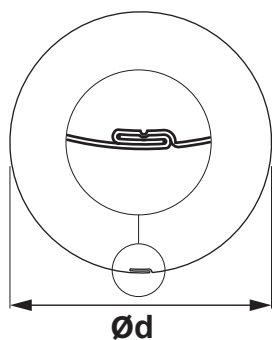

DIMENZIJE STREŠNIH ODOČNIH CEVI

(dimenzije in toleranca po EN 612)

Dimenzije	60	80	100	120	150
Imenska velikost Ød (mm)	60	80	100	120	150

DIMENZIJE STREŠNIH KAVLJEV

(dimenzije in toleranca po EN 612)

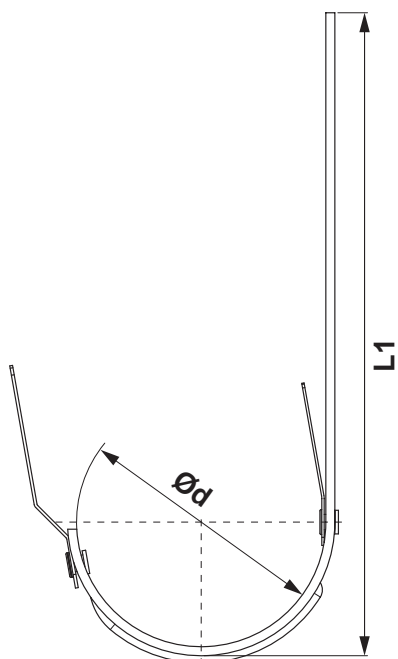

Dimenzije (mm)	L1	Ød
200	290	80
250	310	105
280	345	127
333 – 550	385	153
333 – 610	445	153
400	400	192

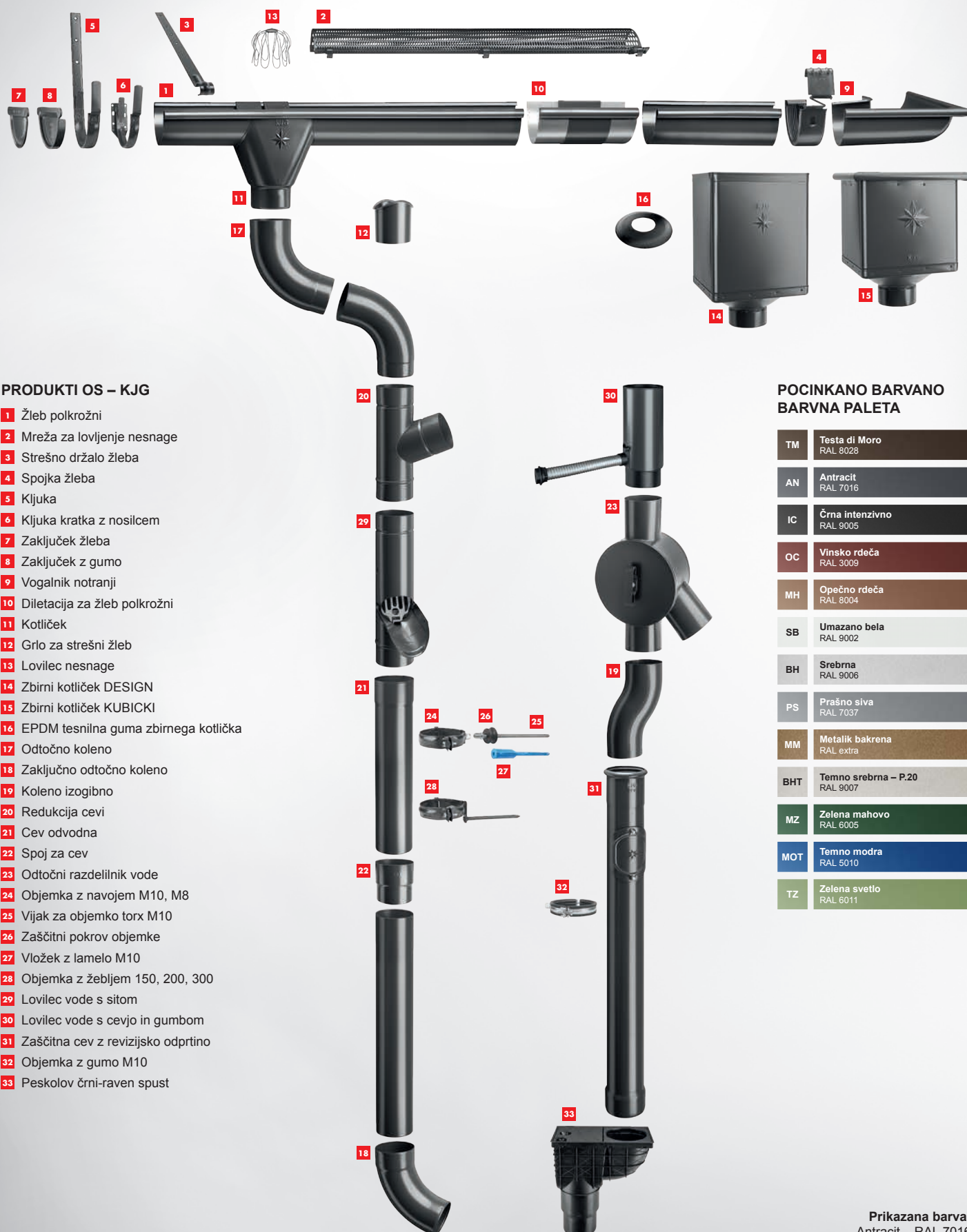

PRODUKTI OS – KJG

- 1 Žleb polkrožni
- 2 Mreža za lovljenje nesnage
- 3 Strešno držalo žleba
- 4 Spojka žleba
- 5 Kljuka
- 6 Kljuka kratka z nosilcem
- 7 Zaključek žleba
- 8 Zaključek z gumo
- 9 Vogalnik notranji
- 10 Diletacija za žleb polkrožni
- 11 Kottiček
- 12 Grlo za strešni žleb
- 13 Lovilec nesnage
- 14 Zbirni kottiček DESIGN
- 15 Zbirni kottiček KUBICKI
- 16 EPDM tesnilna guma zbirnega kottička
- 17 Odtočno koleno
- 18 Zaključno odtočno koleno
- 19 Koleno izogibno
- 20 Redukcija cevi
- 21 Cev odvodna
- 22 Spoj za cev
- 23 Odtočni razdelilnik vode
- 24 Objemka z navojem M10, M8
- 25 Vijak za objemko torx M10
- 26 Zaščitni pokrov objemke
- 27 Vložek z lamelo M10
- 28 Objemka z žebljem 150, 200, 300
- 29 Lovilec vode s sitom
- 30 Lovilec vode s cevjo in gumbom
- 31 Zaščitna cev z revizijsko odprtino
- 32 Objemka z gumo M10
- 33 Peskolov črni-raven spust

POCINKANO BARVANO BARVNA PALETA

TM	Testa di Moro RAL 8028
AN	Antracit RAL 7016
IC	Črna intenzivno RAL 9005
OC	Vinsko rdeča RAL 3009
MH	Opešno rdeča RAL 8004
SB	Umazano bela RAL 9002
BH	Srebrna RAL 9006
PS	Prašno siva RAL 7037
MM	Metalik bakrena RAL extra
BHT	Temno srebrna – P.20 RAL 9007
MZ	Zelena mahovo RAL 6005
MOT	Temno modra RAL 5010
TZ	Zelena svetlo RAL 6011

TATA STEEL





Družbo Tata je leta 1868 ustanovila družba Jamsetji Nusserwanji Tata s sedežem v Indiji. Je globalni poslovni konglomerat, ki deluje v več kot 100 državah na petih kontinentih. Od zgodnjega vstopa v industrijo jekla in avtomobilov, za namen ohranjanja koraka z najnovejšimi tehnologijami, ima danes skupina Tata močan položaj v različnih panogah, kot so fitofarmaceutvska sredstva, avtomobilska industrija, kemikalije, gradbeništvo, finance, izdelki široke porabe in gostinstvo.

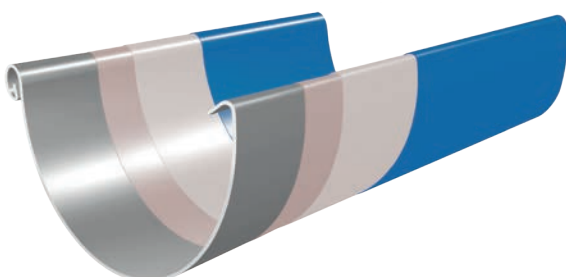

MARCEGAGLIA

Marcegaglia je vodilni igralec v Italiji in največji neodvisni globalni operator v jeklarski industriji. Vsako leto predela 5,6 milijona ton, s prometom več kot 5 milijard evro (2017) je Marcegaglia italijanska industrijska skupina, ki je vodilni igralec v Evropi in celem svetu. Pridobljeno vodstvo je rezultat dolge, trdne in stabilne rasti, ki dela iz družbe Marcegaglia največjega neodvisnega globalnega igralca v predelavi jekla.





-  Zgornji sloj je lak (cca 20 μm) na osnovi poliestra za odličen izgled in izvrstno odpornost na praske
-  Primer (cca 5 μm) za odlično prileganje in močno zaščito proti koroziji
-  Sloj cinka (225 g/m²) za trajno zaščito proti koroziji
-  Jeklena pločevina optimizirana za proizvodnjo odvodnega sistema OS – KJG

POCINKANO POLYESTER

ŽLEB POLKROŽNI [s=0,55]

P-PZ

Nominalna velikost	200		200		200	
	2,0		3,0		4,0	
Dolžina v m	2,0		3,0		4,0	
Cena v €/m	Brez DDV	Z DDV	Brez DDV	Z DDV	Brez DDV	Z DDV
TM 1 Testa di Moro RAL 8028	6,95	8,48	6,95	8,48	6,95	8,48
	043610		043627		043634	
AN 2 Antracit RAL 7016	6,95	8,48	6,95	8,48	6,95	8,48
	042187		042194		042200	
IC 3 Črna intenzivno RAL 9005	6,95	8,48	6,95	8,48	6,95	8,48
	042545		042552		042569	
OC 4 Vinsko rdeča RAL 3009			6,95	8,48	6,95	8,48
			043191		043207	
MH 5 Opečno rdeča RAL 8004			7,05	8,60		
			042750			
SB 6 Umazano bela RAL 9002			7,05	8,60		
			043498			
BH 7 Srebrna RAL 9006			7,05	8,60	7,05	8,60
			042392		042408	
PS 8 Prašno siva RAL 7037			7,05	8,60	7,05	8,60
			043375		043382	
MM 9 Metalik bakrena RAL extra			7,50	9,15		
			042927			
BHT – P.20 10 Temno srebrna RAL 9007						
MZ 11 Zelena mahovo RAL 6005			7,50	9,15		
			043085			
MOT 12 Temno modra RAL 5010			7,50	9,15		
			043016 *			
TZ 13 Zelena svetlo RAL 6011			7,50	9,15		
			043825 *			
Pakiranje v m 			15			
Pakiranje v m 	800		1 200		1 600	

* Izdelava po meri

POCINKANO
POLYESTER



POCINKANO POLYESTER

ŽLEB POLKROŽNI [s=0,55]

P-PZ

Nominalna velikost	250		250		250		250		250		
Dolžina v m	2,0		3,0		4,0		5,0		6,0		
Cena v €/m	Brez DDV	Z DDV	Brez DDV	Z DDV	Brez DDV	Z DDV	Brez DDV	Z DDV	Brez DDV	Z DDV	
TM Testa di Moro RAL 8028	1	6,20	7,56	6,05	7,38	6,05	7,38	6,05	7,38	6,05	7,38
		043641		043658		043665		043672		043689	
AN Antracit RAL 7016	2	6,20	7,56	6,05	7,38	6,05	7,38	6,05	7,38	6,05	7,38
		042217		042224		042231		042248		042255	
IC Črna intenzivno RAL 9005	3	6,20	7,56	6,05	7,38	6,05	7,38	6,05	7,38	6,05	7,38
		042576		042583		042590		042606		042613	
OC Vinsko rdeča RAL 3009	4	6,20	7,56	6,05	7,38	6,05	7,38	6,05	7,38	6,05	7,38
		043214		043221		043238		043245		043252	
MH Opečno rdeča RAL 8004	5	6,30	7,69	6,15	7,50	6,15	7,50	6,15	7,50	6,15	7,50
		042774		042781		042798		042804		042811	
SB Umazano bela RAL 9002	6			6,15	7,50	6,15	7,50			6,15	7,50
				043504		043511				043528	
BH Srebrna RAL 9006	7			6,15	7,50	6,15	7,50	6,15	7,50	6,15	7,50
				042415		042422		042439		042446	
PS Prašno siva RAL 7037	8					6,15	7,50			6,15	7,50
						043399				043405	
MM Metalik bakrena RAL extra	9					6,50	7,93			6,50	7,93
						042934				042941	
BHT – P.20 Temno srebrna RAL 9007	10					7,50	9,15				
						095466					
MZ Zelena mahovo RAL 6005	11					6,50	7,93			6,50	7,93
						043092				043108	
MOT Temno modra RAL 5010	12					6,50	7,93				
						043023					
TZ Zelena svetlo RAL 6011	13					6,50	7,93				
						043832					
Pakiranje v m											
Pakiranje v m		480		720		960		1 200		1 440	



ŽLEB POLKROŽNI [s=0,55]
P-PZ

Nominalna velikost	280		280		280		280		280		
Dolžina v m	2,0		3,0		4,0		5,0		6,0		
Cena v €/m	Brez DDV	Z DDV	Brez DDV	Z DDV	Brez DDV	Z DDV	Brez DDV	Z DDV	Brez DDV	Z DDV	
TM Testa di Moro RAL 8028	1	7,00	8,54	6,85	8,36	6,85	8,36	6,85	8,36	6,85	8,36
		043696		043702		043719		043726		043733	
AN Antracit RAL 7016	2	7,00	8,54	6,85	8,36	6,85	8,36	6,85	8,36	6,85	8,36
		042262		042279		042286		042293		042309	
IC Črna intenzivno RAL 9005	3	7,00	8,54	6,85	8,36	6,85	8,36	6,85	8,36	6,85	8,36
		042620		042637		042644		042651		042668	
OC Vinsko rdeča RAL 3009	4			6,85	8,36	6,85	8,36	6,85	8,36	6,85	8,36
				043269		043276		043283		043290	
MH Opečno rdeča RAL 8004	5			6,95	8,48	6,95	8,48			6,95	8,48
				042828		042835				042842	
SB Umazano bela RAL 9002	6					6,95	8,48			6,95	8,48
						043535				043542	
BH Srebrna RAL 9006	7			6,95	8,48	6,95	8,48			6,95	8,48
				042453		042460				042477	
PS Prašno siva RAL 7037	8					6,95	8,48			6,95	8,48
						043412				043429	
MM Metalik bakrena RAL extra	9					7,45	9,09			7,45	9,09
						042958				042965	
BHT – P.20 Temno srebrna RAL 9007	10					8,40	10,25				
						095473					
MZ Zelena mahovo RAL 6005	11					7,45	9,09			7,45	9,09
						043115				043122	
MOT Temno modra RAL 5010	12					7,45	9,09				
						043030					
TZ Zelena svetlo RAL 6011	13					7,45	9,09				
						043849					
Pakiranje v m 						20		25			
Pakiranje v m 		420		630		840		1 050		1 260	

 POCINKANO
POLYESTER

POCINKANO POLYESTER

ŽLEB POLKROŽNI [s=0,55]

P-PZ

Nominalna velikost	333		333		333		333		333		
Dolžina v m	2,0		3,0		4,0		5,0		6,0		
Cena v €/m	Brez DDV	Z DDV	Brez DDV	Z DDV	Brez DDV	Z DDV	Brez DDV	Z DDV	Brez DDV	Z DDV	
TM Testa di Moro RAL 8028	1	7,30	8,91	7,10	8,66	7,10	8,66	7,10	8,66	7,10	8,66
		043740		043757		043764		043771		043788	
AN Antracit RAL 7016	2	7,30	8,91	7,10	8,66	7,10	8,66	7,10	8,66	7,10	8,66
		042316		042323		042330		042347		042354	
IC Črna intenzivno RAL 9005	3	7,30	8,91	7,10	8,66	7,10	8,66	7,10	8,66	7,10	8,66
		042675		042682		042699		042705		042712	
OC Vinsko rdeča RAL 3009	4	7,30	8,91	7,10	8,66	7,10	8,66	7,10	8,66	7,10	8,66
		043306		043313		043320		043337		043344	
MH Opečno rdeča RAL 8004	5	7,40	9,03	7,20	8,78	7,20	8,78	7,20	8,78	7,20	8,78
		042859		042866		042873		042880		042897	
SB Umazano bela RAL 9002	6			7,20	8,78	7,20	8,78	7,20	8,78	7,20	8,78
				043559		043566		043573		043580	
BH Srebrna RAL 9006	7			7,20	8,78	7,20	8,78	7,20	8,78	7,20	8,78
				042484		042491		042507		042514	
PS Prašno siva RAL 7037	8			7,20	8,78	7,20	8,78	7,20	8,78	7,20	8,78
				043436		043443		043450		043467	
MM Metalik bakrena RAL extra	9					8,30	10,13	8,30	10,13	8,30	10,13
						042972		042989		042996	
BHT – P.20 Temno srebrna RAL 9007	10					8,50	10,37			8,50	10,37
						095480				095497	
MZ Zelena mahovo RAL 6005	11					8,30	10,13	8,30	10,13	8,30	10,13
						043139		043146		043153	
MOT Temno modra RAL 5010	12					8,30	10,13			8,30	10,13
						043047				043054	
TZ Zelena svetlo RAL 6011	13					8,30	10,13				
						043856					
Pakiranje v m 		10				20		25		30	
Pakiranje v m 		330		495		660		825		990	



POCINKANO POLYESTER

ŽLEB POLKROŽNI [s=0,55]

P-PZ

Nominalna velikost	400		400		500		500		333		
Dolžina v m	4,0		6,0		4,0		6,0		7,0		
Cena v €/m	Brez DDV	Z DDV	Brez DDV	Z DDV	Brez DDV	Z DDV	Brez DDV	Z DDV	Brez DDV	Z DDV	
TM Testa di Moro RAL 8028	1	11,45	13,97	11,45	13,97					7,10	8,66
		043801		043818						043795 *	
AN Antracit RAL 7016	2	11,45	13,97	11,45	13,97	15,50	18,91	15,50	18,91		
		042361		042378		086730 *		086747 *			
IC Črna intenzivno RAL 9005	3	11,45	13,97	11,45	13,97						
		042729		042736							
OC Vinsko rdeča RAL 3009	4	11,45	13,97	11,45	13,97						
		043351		043368							
MH Opečno rdeča RAL 8004	5	11,55	14,09	11,55	14,09						
		042903		042910							
SB Umazano bela RAL 9002	6	11,55	14,09	11,55	14,09	15,60	19,03	15,60	19,03		
		043597		043603		086778 *		086785 *			
BH Srebrna RAL 9006	7	11,55	14,09	11,55	14,09	15,60	19,03	15,60	19,03		
		042521		042538		086754 *		086761 *			
PS Prašno siva RAL 7037	8	11,55	14,09	11,55	14,09						
		043474		043481							
MM Metalik bakrena RAL extra	9	12,15	14,82								
		043009									
BHT – P.20 Temno srebrna RAL 9007	10			12,80	15,62						
				095503							
MZ Zelena mahovo RAL 6005	11	12,15	14,82	12,15	14,82						
		043160		043177 *							
MOT Temno modra RAL 5010	12	12,15	14,82	12,15	14,82						
		043061		043078							
TZ Zelena svetlo RAL 6011	13	12,15	14,82								
		043863 *									
Pakiranje v m 		20		30						35	
Pakiranje v m 		540		810		-		-		1 155	

* Izdelava po meri

POCINKANO
POLYESTER



POCINKANO POLYESTER

ŽLEB POLKROŽNI [s=0,50]

P-PZ

Nominalna velikost	250		250		250		250		250		
Dolžina v m	2,0		3,0		4,0		5,0		6,0		
Cena v €/m	Brez DDV		Brez DDV		Brez DDV		Brez DDV		Brez DDV		
TM Testa di Moro RAL 8028	1	5,30	6,47	5,30	6,47	5,30	6,47	5,30	6,47	5,30	6,47
		069184 *		069191		069207		069009 *		069214 *	
AN Antracit RAL 7016	2			4,70	5,73	4,70	5,73	4,70	5,73	4,70	5,73
				068729		068736		068743 *		068750 *	
IC Črna intenzivno RAL 9005	3			5,30	6,47	5,30	6,47	5,30	6,47	5,30	6,47
				068965		068972		068989 *		068996 *	
OC Vinsko rdeča RAL 3009	4			5,30	6,47	5,30	6,47	5,30	6,47	5,30	6,47
				069108 *		069115		069122 *		069139 *	
BH Srebrna RAL 9006	5			5,30	6,47	5,30	6,47	5,30	6,47	5,30	6,47
				068842 *		068859		068866 *		068873 *	
TH Tmavo hreda ČOKO RAL 8017	6			5,30	6,47	5,30	6,47			5,30	6,47
				084774 *		084781				084804 *	
MH Opečno rdeča RAL 8004	9			5,30	6,47	5,30	6,47	5,30	6,47	5,30	6,47
				084934 *		84941		084958 *		084965 *	
Pakiranje v m		10		15		20		25		30	
Pakiranje v m		480		720		960		1 200		1 440	

* Izdelava po meri

ŽLEB POLKROŽNI [s=0,50]

P-PZ

Nominalna velikost	280		280		280		280		
Dolžina v m	3,0		4,0		5,0		6,0		
Cena v €/m	Brez DDV		Brez DDV		Brez DDV		Brez DDV		
TM Testa di Moro RAL 8028	1	5,80	7,08	5,80	7,08	5,80	7,08	5,80	7,08
		069238 *		069245		069252 *		069269 *	
AN Antracit RAL 7016	2	5,15	6,28	5,15	6,28	5,15	6,28	5,15	6,28
		068767 *		068774		068781 *		068798 *	
IC Črna intenzivno RAL 9005	3	5,80	7,08	5,80	7,08	5,80	7,08	5,80	7,08
		069016 *		069023		069030 *		069047 *	
OC Vinsko rdeča RAL 3009	4	5,80	7,08	5,80	7,08	5,80	7,08	5,80	7,08
		069054 *		084767		084811 *		084866 *	
BH Srebrna RAL 9006	5	5,80	7,08	5,80	7,08	5,80	7,08	5,80	7,08
		068880 *		068897		068903 *		068910 *	
TH Tmavo hreda ČOKO RAL 8017	6			5,80	7,08			5,80	7,08
				084835 *				084859 *	
MH Opečno rdeča RAL 8004	9	5,80	7,08	5,80	7,08	5,80	7,08	5,80	7,08
		084989 *		084996		085009 *		085016 *	
Pakiranje v m		15		20		25		30	
Pakiranje v m		630		840		1 050		1 260	

* Izdelava po meri

POCINKANO POLYESTER

ŽLEB POLKROŽNI [s=0,50]

P-PZ

Nominalna velikost	333		333		333	
Dolžina v m	2,0		3,0		4,0	
Cena v €/m	Brez DDV	Z DDV	Brez DDV	Z DDV	Brez DDV	Z DDV
TM Testa di Moro RAL 8028	6,50	7,93	6,50	7,93	6,50	7,93
	069276 *		069283 *		069290	
AN Antracit RAL 7016			5,75	7,02	5,75	7,02
			068804 *		068811	
IC Črna intenzivno RAL 9005			6,50	7,93	6,50	7,93
			069061 *		069078	
OC Vinsko rdeča RAL 3009			6,50	7,93	6,50	7,93
			069146 *		069153	
BH Srebrna RAL 9006			6,50	7,93	6,50	7,93
			068927 *		068934	
TH Tmavo hredá ČOKO RAL 8017			6,50	7,93	6,50	7,93
			084873 *		084880	
MH Opečno rdeča RAL 8004			6,50	7,93	6,50	7,93
			085030 *		085047	
Pakiranje v m	10		15		20	
Pakiranje v m	330		495		660	

* Izdelava po meri

ŽLEB POLKROŽNI [s=0,50]

P-PZ

Nominalna velikost	333		333		333	
Dolžina v m	5,0		6,0		7,0	
Cena v €/m	Brez DDV	Z DDV	Brez DDV	Z DDV	Brez DDV	Z DDV
TM Testa di Moro RAL 8028	6,50	7,93	6,50	7,93	6,50	7,93
	069306 *		069313 *		069320 *	
AN Antracit RAL 7016	5,75	7,02	5,75	7,02		
	068828 *		068835 *			
IC Črna intenzivno RAL 9005	6,50	7,93	6,50	7,93		
	069085 *		069092 *			
OC Vinsko rdeča RAL 3009	6,50	7,93	6,50	7,93		
	069160 *		069177 *			
BH Srebrna RAL 9006	6,50	7,93	6,50	7,93		
	068941 *		068958 *			
TH Tmavo hredá ČOKO RAL 8017	6,50	7,93	6,50	7,93		
	084897		084903			
MH Opečno rdeča RAL 8004	6,50	7,93	6,50	7,93		
	085054 *		085061 *			
Pakiranje v m	25		30		35	
Pakiranje v m	825		990		1 155	

* Izdelava po meri

POCINKANO POLYESTER

ŽLEB LEŽEČI [s=0,55]

P-PZS

Nominalna velikost	650		650	
Dolžina v m	4,0		6,0	
Cena v €/m	Brez DDV	Z DDV	Brez DDV	Z DDV
TM Testa di Moro RAL 8028	24,50	29,89	24,50	29,89
	049926		049933	
AN Antracit RAL 7016	24,50	29,89	24,50	29,89
	049759		049766	
IC Črna intenzivno RAL 9005	24,50	29,89	24,50	29,89
	049797		049803	
OC Vinsko rdeča RAL 3009	24,50	29,89	24,50	29,89
	049865		049872	
MH Opečno rdeča RAL 8004	25,50	31,11	25,50	31,11
	049810		049827	
SB Umazano bela RAL 9002	25,50	31,11		
	049902			
BH Srebrna RAL 9006	25,50	31,11	25,50	31,11
	049773		049780	
PS Prašno siva RAL 7037	25,50	31,11		
	049889			
MM Metalik bakrena RAL extra	28,00	34,16		
	049834			
BHT – P.20 Temno srebrna RAL 9007	32,50	39,65		
	095749 *			
MZ Zelena mahovo RAL 6005	28,00	34,16		
	049858			
MOT Temno modra RAL 5010	28,00	34,16		
	049841 *			
TZ Zelena svetlo RAL 6011	28,00	34,16		
	049940 *			
Pakiranje v m 	4		6	
Pakiranje v m 	200		300	

* Izdelava po meri



DILETACIJA ZA ŽLEB POLKROŽNI

P-PZDI

Nominalna velikost	250/260		280/260		333/260		400/260	
	Brez DDV	Z DDV	Brez DDV	Z DDV	Brez DDV	Z DDV	Brez DDV	Z DDV
TM 1 Testa di Moro RAL 8028	14,60	17,81	15,50	18,91	16,90	20,62	19,90	24,28
	013064		013071		013088		013095	
AN 2 Antracit RAL 7016	14,60	17,81	15,50	18,91	16,90	20,62	19,90	24,28
	012661		012678		012685		012692	
IC 3 Črna intenzivno RAL 9005	14,60	17,81	15,50	18,91	16,90	20,62	19,90	24,28
	012746 *		012753 *		012760		012777 *	
OC 4 Vinsko rdeča RAL 3009	14,60	17,81	15,50	18,91	16,90	20,62	19,90	24,28
	012944 *		012951 *		012968 *		012975 *	
MH 5 Opečno rdeča RAL 8004	14,60	17,81	15,50	18,91	16,90	20,62	19,90	24,28
	012784 *		012791 *		012807 *		012814 *	
SB 6 Umazano bela RAL 9002	14,60	17,81	15,50	18,91	16,90	20,62	19,90	24,28
	013026 *		013033 *		013040 *		013057 *	
BH 7 Srebrna RAL 9006	14,60	17,81	15,50	18,91	16,90	20,62	19,90	24,28
	012708 *		012715 *		012722 *		012739 *	
PS 8 Prašno siva RAL 7037	14,60	17,81	15,50	18,91	16,90	20,62	19,90	24,28
	012982 *		012999 *		013002 *		013019 *	
MM 9 Metalik bakrena RAL extra	14,60	17,81	15,50	18,91	16,90	20,62	19,90	24,28
	012821 *		012838 *		012845 *		012852 *	
BHT – P.20 10 Temno srebrna RAL 9007	14,60	17,81	15,50	18,91	16,90	20,62	19,90	24,28
	096098 *		096104 *		096111 *		114044 *	
MZ 11 Zelena mahovo RAL 6005	14,60	17,81	15,50	18,91	16,90	20,62	19,90	24,28
	012906 *		012913 *		012920 *		012937 *	
MOT 12 Temno modra RAL 5010	14,60	17,81	15,50	18,91	16,90	20,62	19,90	24,28
	012869 *		012876 *		012883 *		012890 *	
TZ 13 Zelena svetlo RAL 6011	14,60	17,81	15,50	18,91	16,90	20,62	19,90	24,28
	013101 *		013118 *		013125 *		013132 *	
Pakiranje v kos 	3		3		5		5	
Pakiranje v kos 	360		360		200		200	

* Izdelava po meri

POCINKANO
POLYESTER

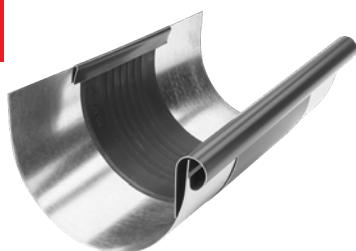

DILETACIJA ZA LEŽEČI ŽLEB

P-PZSDI



Nominalna velikost	670/260	
Cena v €/kos	Brez DDV	Z DDV
TM 1 Testa di Moro RAL 8028	31,50	38,43
	013637 *	
AN 2 Antracit RAL 7016	31,50	38,43
	013545 *	
IC 3 Črna intenzivno RAL 9005	31,50	38,43
	013569 *	
OC 4 Vinsko rdeča RAL 3009	31,50	38,43
	013606 *	
MH 5 Opečno rdeča RAL 8004	31,50	38,43
	013576 *	
SB 6 Umazano bela RAL 9002	31,50	38,43
	013620 *	
BH 7 Srebrna RAL 9006	31,50	38,43
	013552 *	
PS 8 Prašno siva RAL 7037	31,50	38,43
	013613 *	
MM 9 Metalik bakrena RAL extra	31,50	38,43
	013583 *	
BHT – P.20 10 Temno srebrna RAL 9007	31,50	38,43
	096067 *	
MZ 11 Zelena mahovo RAL 6005	31,50	38,43
	013651 *	
MOT 12 Temno modra RAL 5010	31,50	38,43
	013590 *	
TZ 13 Zelena svetlo RAL 6011	31,50	38,43
	013644 *	
Pakiranje v kos	1	
Pakiranje v kos	40	

* Izdelava po meri

DILETACIJSKI TRAK

P-PZDIP



Nominalna velikost	Dolžina v m	EAN številko izdelka	Pakiranje v m		Cena [€/m]	
					Brez DDV	Z DDV
260	3,0	012470	3	120	33,60	40,99
260	6,0	012487	6	240	33,60	40,99

UPORABA DILATACIJSKEGA ŽLEBA IN DILATACIJSKEGA TRAKU

DILATACIJSKI ŽLEB

Primer montaže: Razvite širine do 500 mm. Dilatacijski žleb mora biti nameščen z razmikom 15 m. Za zunanji vogal in začetek žleba velja polovica standardne vrednosti: največ 7,5 m. Za notranji vogal velja četrtina standardne vrednosti: največ 3,75 m. Za druge materiale in dimenzije: glej tabelo spodaj. Vogali vedno štejejo kot fiksne točke.

DILATACIJSKI TRAK

Notranja namestitvev: na žlebove pritrjen brez lepljenja na podlago, strehe z nestandardnim profilom in pločevinsko obrobo zidov

STREŠNI POLOGLATI DILATACIJSKI ŽLEBOVI

Razvita širina žleba	Aluminij	Pocinkano, Cinkotit, Baker, Inox
< 500	12	15
> 500	8	10

STREŠNI DILATACIJSKI TRAK

Razvita širina žleba	Aluminij	Pocinkano, Cinkotit, Baker, Inox
< 500	8	10
> 500	6	8

Za zunanji vogal ali začetek žleba velja polovica standardne vrednosti. Za notranji vogal velja ena četrtina standardne vrednosti.

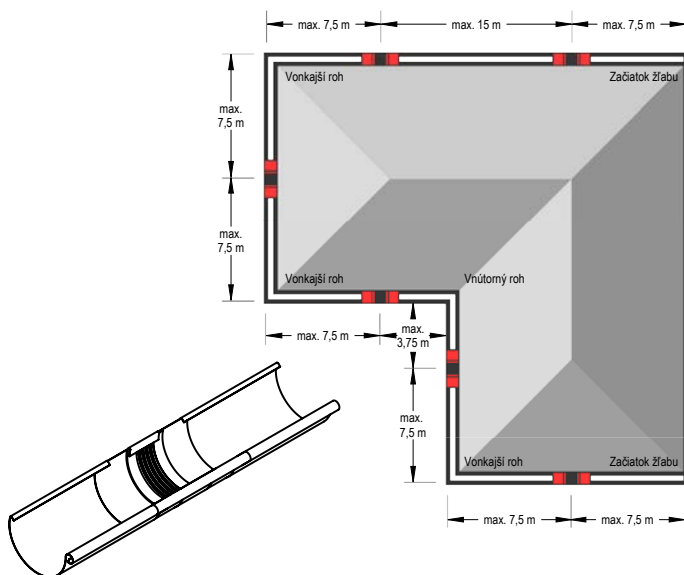

Opomba za montažo dilatacijskega žleba

Pri montaži s spajkanjem najprej srednji gumijasti del pokrijte z mokro krpo (da ne pride do prehoda toplotev srednji gumijasti del). Upoštevati je potrebno minimalno razdaljo 6 cm od srednjega gumijastega dela. V vsakem primeru se izogibajte kontaktu gume z odprtim ognjem.

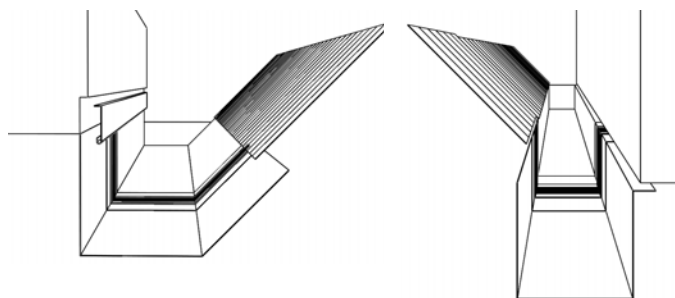

Opomba za montažo dilatacijskega traku

Pri krivljenju in montaži dilatacijskih elementov preverite, ali:

- je radij čeljusti za krivljenje vsaj 2 mm.
- Za debelino pločevine od 1 mm mora biti polmer krivljenja vsaj 5 mm.
- Čeljusti morajo biti za krivljenje nastavljene v debelini srednjega gumijastega dela 3 do 4 mm, da se prepreči učinek rezanja – poškodovanja gume.
- Gumijasti srednji del ne sme biti med krivljenjem stisnjen ali poškodovan. Zato je treba uporabiti aluminijški pločevinski trak 2 do 5 mm (debeline) ukrivljen tako, da se lahko pritrdi kot zaščita na čeljusti. Tako dosežete večji polmer krivljenja in preprečite poškodovanje gumijastega srednjega dela.

ALUMINIJ MREŽA ZA LOVLJENJE NESNAGE

P-PZNLNLM

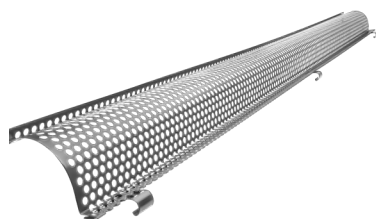



Nominalna velikost	333	
Dolžina v m	2,0	
Cena v €/kos	Brez DDV	Z DDV
TM 1 Testa di Moro RAL 8028	26,50	32,33
	064943	
AN 2 Antracit RAL 7016	26,50	32,33
	064912	
IC 3 Črna intenzivno RAL 9005	26,50	32,33
	064929 *	
OC 4 Vinsko rdeča RAL 3009	26,50	32,33
	064936 *	
MH 5 Opečno rdeča RAL 8004	26,50	32,33
	119766 *	
SB 6 Umazano bela RAL 9002	26,50	32,33
	117762 *	
BH 7 Srebrna RAL 9006	26,50	32,33
	117717 *	
PS 8 Prašno siva RAL 7037	26,50	32,33
	117755 *	
MM 9 Metalik bakrena RAL extra	26,50	32,33
	117724 *	
BHT – P.20 10 Temno srebrna RAL 9007	26,50	32,33
	097156 *	
MZ 11 Zelena mahovo RAL 6005	26,50	32,33
	117748 *	
MOT 12 Temno modra RAL 5010	26,50	32,33
	117731 *	
TZ 13 Zelena svetlo RAL 6011	26,50	32,33
	117779 *	
Pakiranje v kos	15	
Pakiranje v kos	120	

* Izdelava po meri

POCINKANO POLYESTER



PVC MREŽA ZA LOVLJENJE LISTJA

SD-ZNL MREZKA

Nominalna velikost	Dolžina v m	EAN številko izdelka	Pakiranje v kos		Cena [€/kos]	
					Brez DDV	Z DDV
PS 171	1,0	008473	30	450	4,50	5,49
TM 171	1,0	008466	30	450	4,50	5,49

PVC MREŽA ZA LOVLJENJE LISTJA

SD-ZNL N

Nominalna velikost	Dolžina v m	EAN številko izdelka	Pakiranje v kos		Cena [€/kos]	
					Brez DDV	Z DDV
250	3,0	008480	10	400	23,90	29,16
280-333	3,0	008497	10	400	24,00	29,28

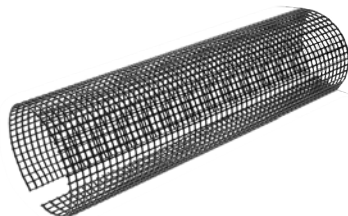
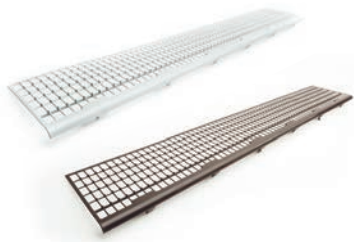

STREŠNO DRŽALO ŽLEBA

P-PDZNV



Nominalna velikost	250-280		333		400	
	18		20		22	
Velikost v mm						
Cena v €/kos	Brez DDV	Z DDV	Brez DDV	Z DDV	Brez DDV	Z DDV
TM 1 Testa di Moro RAL 8028	1,60	1,95	1,60	1,95	1,60	1,95
	085665		085672		085689 *	
AN 2 Antracit RAL 7016	1,60	1,95	1,60	1,95	1,60	1,95
	085290		085306		085313	
IC 3 Črna intenzivno RAL 9005	1,60	1,95	1,60	1,95	1,60	1,95
	085351		085368		085375 *	
OC 4 Vinsko rdeča RAL 3009	1,60	1,95	1,60	1,95	1,60	1,95
	085504		085573		085597 *	
MH 5 Opečno rdeča RAL 8004	1,60	1,95	1,60	1,95	1,60	1,95
	085382		085399		085405 *	
SB 6 Umazano bela RAL 9002	1,60	1,95	1,60	1,95	1,60	1,95
	085634 *		085641		085658 *	
BH 7 Srebrna RAL 9006	1,60	1,95	1,60	1,95	1,60	1,95
	085320		085337		085344 *	
PS 8 Prašno siva RAL 7037	1,60	1,95	1,60	1,95	1,60	1,95
	085603		085610		085627 *	
MM 9 Metalik bakrena RAL extra	1,60	1,95	1,60	1,95	1,60	1,95
	085412 *		085429		085436 *	
BHT – P.20 10 Temno srebrna RAL 9007	1,60	1,95	1,60	1,95	1,60	1,95
	094636 *		094643 *		094650 *	
MZ 11 Zelena mahovo RAL 6005	1,60	1,95	1,60	1,95	1,60	1,95
	085474 *		085481 *		085498 *	
MOT 12 Temno modra RAL 5010	1,60	1,95	1,60	1,95	1,60	1,95
	085443 *		085450 *		085467 *	
TZ 13 Zelena svetlo RAL 6011	1,60	1,95	1,60	1,95	1,60	1,95
	085696 *		085702 *		085719 *	
Pakiranje v kos 	25		25		25	
Pakiranje v kos 	3 000		3 000		3 000	

* Izdelava po meri



SPOJKA ŽLEBA

P-PSPZ

Nominalna velikost	250		280		333	
	Brez DDV	Z DDV	Brez DDV	Z DDV	Brez DDV	Z DDV
TM 1 Testa di Moro RAL 8028	3,80	4,64	3,80	4,64	4,00	4,88
	083852		083869		083876	
AN 2 Antracit RAL 7016	3,80	4,64	3,80	4,64	4,00	4,88
	083456		083463		083470	
IC 3 Črna intenzivno RAL 9005	3,80	4,64	3,80	4,64	4,00	4,88
	083531		083548		083555	
OC 4 Vinsko rdeča RAL 3009	3,80	4,64	3,80	4,64	4,00	4,88
	083739		083746		083753	
MH 5 Opečno rdeča RAL 8004	3,80	4,64	3,80	4,64	4,00	4,88
	083579		083586		083593	
SB 6 Umazano bela RAL 9002	3,80	4,64	3,80	4,64	4,00	4,88
	083814		083821		083838	
BH 7 Srebrna RAL 9006	3,80	4,64	3,80	4,64	4,00	4,88
	083494		083500		083517	
PS 8 Prašno siva RAL 7037	3,80	4,64	3,80	4,64	4,00	4,88
	083777		083784		083791	
MM 9 Metalik bakrena RAL extra	3,80	4,64	3,80	4,64	4,00	4,88
	083616		083623		083630	
BHT – P.20 10 Temno srebrna RAL 9007	3,80	4,64	3,80	4,64	4,00	4,88
	094681		094698 *		094704	
MZ 11 Zelena mahovo RAL 6005	3,80	4,64	3,80	4,64	4,00	4,88
	083692		083708		083715	
MOT 12 Temno modra RAL 5010	3,80	4,64	3,80	4,64	4,00	4,88
	083654		083661		083678	
TZ 13 Zelena svetlo RAL 6011	3,80	4,64	3,80	4,64	4,00	4,88
	083890 *		083906 *		083913	
Pakiranje v kos 	5		5		5	
Pakiranje v kos 	600		600		600	

* Izdelava po meri

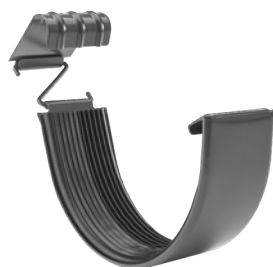

KLJUKA

P-PHP

Nominalna velikost	200/380		250/430		280/480		280/480	
Material	25/4		25/5		25/5		30/5	
Cena v €/kos	Brez DDV	Z DDV	Brez DDV	Z DDV	Brez DDV	Z DDV	Brez DDV	Z DDV
TM Testa di Moro RAL 8028	3,30	4,03	2,95	3,60	3,15	3,84	3,45	4,21
	045362		045379		045386		045393	
AN Antracit RAL 7016	3,30	4,03	2,95	3,60	3,15	3,84	3,45	4,21
	044648		044655		044662		044679	
IC Črna intenzivno RAL 9005	3,30	4,03	2,95	3,60	3,15	3,84	3,45	4,21
	044808		044815		044822		044839	
OC Vinsko rdeča RAL 3009	3,30	4,03	2,95	3,60	3,15	3,84	3,45	4,21
	045140		045157		045164		045171	
MH Opečno rdeča RAL 8004	3,30	4,03	2,95	3,60	3,15	3,84	3,45	4,21
	044884		044891		044907		044914	
SB Umazano bela RAL 9002	3,30	4,03	2,95	3,60	3,15	3,84	3,45	4,21
	045287		045294		045300		045317	
BH Srebrna RAL 9006	3,30	4,03	2,95	3,60	3,15	3,84	3,45	4,21
	044723		044730		044747		044754	
PS Prašno siva RAL 7037	3,30	4,03	2,95	3,60			3,45	4,21
	045225		045232				045249	
MM Metalik bakrena RAL extra	3,30	4,03	2,95	3,60			3,45	4,21
	044969		044976				044983	
BHT – P.20 Temno srebrna RAL 9007			2,95	3,60			3,45	4,21
			095961				095978	
MZ Zelena mahovo RAL 6005	3,30	4,03	2,95	3,60			3,45	4,21
	045089		045096				045102	
MOT Temno modra RAL 5010	3,30	4,03	2,95	3,60			3,45	4,21
	045027		045034				045041	
TZ Zelena svetlo RAL 6011	3,30	4,03	2,95	3,60			3,45	4,21
	045454 *		045461				045478	
Pakiranje v kos 	25		25		25		25	
Pakiranje v kos 	1 000		1 000		1 000		1 000	

* Izdelava po meri



KLJUKA

P-PHP



Nominalna velikost	333/550		333/550		333/550		333/610		400/610		
Material	25/5		30/4		30/5		30/5		30/6		
Cena v €/kos	Brez DDV	Z DDV	Brez DDV	Z DDV	Brez DDV	Z DDV	Brez DDV	Z DDV	Brez DDV	Z DDV	
TM Testa di Moro RAL 8028	1	3,15	3,84	3,30	4,03	3,50	4,27	4,10	5,00	5,90	7,20
		045409		045416 *		045423		045430		045447	
AN Antracit RAL 7016	2	3,15	3,84	3,30	4,03	3,50	4,27	4,10	5,00	5,90	7,20
		044686		080127 *		044693		044709		044716	
IC Črna intenzivno RAL 9005	3	3,15	3,84			3,50	4,27	4,10	5,00	5,90	7,20
		044846				044853		044860		044877	
OC Vinsko rdeča RAL 3009	4	3,15	3,84			3,50	4,27	4,10	5,00	5,90	7,20
		045188				045195		045201		045218	
MH Opečno rdeča RAL 8004	5	3,15	3,84			3,50	4,27	4,10	5,00	5,90	7,20
		044921				044938		044945		044952	
SB Umazano bela RAL 9002	6	3,15	3,84			3,50	4,27	4,10	5,00	5,90	7,20
		045324				045331		045348		045355	
BH Srebna RAL 9006	7	3,15	3,84			3,50	4,27	4,10	5,00	5,90	7,20
		044761				044778		044785		044792	
PS Prašno siva RAL 7037	8					3,50	4,27	4,10	5,00	5,90	7,20
						045256		045263		045270	
MM Metalik bakrena RAL extra	9					3,50	4,27	4,10	5,00	5,90	7,20
						044990		045003		045010	
BHT – P.20 Temno srebna RAL 9007	10					3,50	4,27			5,90	7,20
						095985				095992	
MZ Zelena mahovo RAL 6005	11					3,50	4,27	4,10	5,00	5,90	7,20
						045119		045126		045133	
MOT Temno modra RAL 5010	12					3,50	4,27	4,10	5,00	5,90	7,20
						045058		045065		045072	
TZ Zelena svetlo RAL 6011	13					3,50	4,27	4,10	5,00	5,90	7,20
						045485		045492		045508 *	
Pakiranje v kos 		25		25		25		25		25	
Pakiranje v kos 		1 000		1 000		1 000		1 000		500	

* Izdelava po meri



KLJUKA Z NOSOM

P-PHPN

Nominalna velikost	250/430		280/480		333/550	
Material	25/5		25/5		25/5	
Cena v €/kos	Brez DDV	Z DDV	Brez DDV	Z DDV	Brez DDV	Z DDV
TM Testa di Moro RAL 8028	2,90	3,54	2,90	3,54	3,20	3,90
	095930		095947		095954	
AN Antracit RAL 7016	2,90	3,54	2,90	3,54	3,20	3,90
	095824		095831		095848	
IC Črna intenzivno RAL 9005			2,90	3,54	3,20	3,90
			095879		095886 *	
MH Opečno rdeča RAL 8004			2,90	3,54	3,20	3,90
			095893		095909	
SB Umazano bela RAL 9002			2,90	3,54	3,20	3,90
			095916		095923 *	
BH Srebna RAL 9006			2,90	3,54	3,20	3,90
			095855		095862	
PS Prašno siva RAL 7037					3,20	3,90
					117496 *	
Pakiranje v kos 	25		25		25	
Pakiranje v kos 	1 000		1 000		1 000	

* Izdelava po meri

KLJUKA KRATKA Z DODATNIM NOSILCEM

P-PHPNK



Nominalna velikost	250		280		333	
Material	25/4		25/4		25/5	
Cena v €/kos	Brez DDV	Z DDV	Brez DDV	Z DDV	Brez DDV	Z DDV
TM Testa di Moro RAL 8028	3,15	3,84	3,35	4,09	3,55	4,33
	095435		095442		095459	
AN Antracit RAL 7016	3,15	3,84	3,35	4,09	3,55	4,33
	095312		095329		095336	
IC Črna intenzivno RAL 9005	3,15	3,84	3,35	4,09	3,55	4,33
	095374		095381		095398	
MH Opečno rdeča RAL 8004	3,15	3,84	3,35	4,09	3,55	4,33
	095404		095411		095428	
BH Srebna RAL 9006	3,15	3,84	3,35	4,09	3,55	4,33
	095343 *		095350		095367	
Pakiranje v kos 	25		25		25	
Pakiranje v kos 	1 000		1 000		1 000	

* Izdelava po meri



KLJUKA ZA LEŽEČI ŽLEB

P-PHSSN

Nominalna velikost	4	
Material	20/6	
Cena v €/kos	Brez DDV	Z DDV
TM 1 Testa di Moro RAL 8028	8,60	10,49
	033567	
AN 2 Antracit RAL 7016	8,60	10,49
	033468	
IC 3 Črna intenzivno RAL 9005	8,60	10,49
	033482	
OC 4 Vinsko rdeča RAL 3009	8,60	10,49
	033536	
MH 5 Opečno rdeča RAL 8004	8,60	10,49
	033499	
SB 6 Umazano bela RAL 9002	8,60	10,49
	033550	
BH 7 Srebrna RAL 9006	8,60	10,49
	033475	
PS 8 Prašno siva RAL 7037	8,60	10,49
	033543	
MM 9 Metalik bakrena RAL extra	8,60	10,49
	033505	
BHT – P.20 10 Temno srebrna RAL 9007	8,60	10,49
	095510 *	
MZ 11 Zelena mahovo RAL 6005	8,60	10,49
	033529	
MOT 12 Temno modra RAL 5010	8,60	10,49
	033512 *	
TZ 13 Zelena svetlo RAL 6011	8,60	10,49
	033574	
Pakiranje v kos 	25	
Pakiranje v kos 	1 000	

* Izdelava po meri

POCINKANO
POLYESTER



KLJUKA KRATKA Z NOSILCEM

P-PHPK



Nominalna velikost	200		250		280		333		400	
Material	25/4		25/4		25/4		25/5		30/5	
Cena v €/kos	Brez DDV	Z DDV	Brez DDV	Z DDV	Brez DDV	Z DDV	Brez DDV	Z DDV	Brez DDV	Z DDV
TM Testa di Moro RAL 8028	3,60	4,39	3,40	4,15	3,65	4,45	3,95	4,82	5,50	6,71
	065551		065568		065575		065582		065599	
AN Antracit RAL 7016	3,60	4,39	3,40	4,15	3,65	4,45	3,95	4,82	5,50	6,71
	065056		065063		065070		065087		065094	
IC Črna intenzivno RAL 9005	3,60	4,39	3,40	4,15	3,65	4,45	3,95	4,82	5,50	6,71
	065155		065162		065179		065186		065193 *	
OC Vinsko rdeča RAL 3009	3,60	4,39	3,40	4,15	3,65	4,45	3,95	4,82	5,50	6,71
	065407		065414		065421		065438		065445	
MH Opečno rdeča RAL 8004	3,60	4,39	3,40	4,15	3,65	4,45	3,95	4,82	5,50	6,71
	065209		065216		065223		065230		065247 *	
SB Umazano bela RAL 9002	3,60	4,39	3,40	4,15	3,65	4,45	3,95	4,82	5,50	6,71
	065506		065513		065520		065537		065544	
BH Srebrna RAL 9006	3,60	4,39	3,40	4,15	3,65	4,45	3,95	4,82	5,50	6,71
	065100		065117		065124		065131		065148	
PS Prašno siva RAL 7037	3,60	4,39	3,40	4,15	3,65	4,45	3,95	4,82	5,50	6,71
	065452		065469		065476		065483		065490	
MM Metalik bakrena RAL extra	3,60	4,39	3,40	4,15	3,65	4,45	3,95	4,82	5,50	6,71
	065254		065261		065278		065285		065292 *	
BHT – P.20 Temno srebrna RAL 9007			3,40	4,15	3,65	4,45	3,95	4,82		
			095251		095268		095275			
MZ Zelena mahovo RAL 6005	3,60	4,39	3,40	4,15	3,65	4,45	3,95	4,82	5,50	6,71
	065353		065360		065377		065384		065391 *	
MOT Temno modra RAL 5010	3,60	4,39	3,40	4,15	3,65	4,45	3,95	4,82	5,50	6,71
	065308 *		065315		065322		065339		065346	
TZ Zelena svetlo RAL 6011	3,60	4,39	3,40	4,15	3,65	4,45	3,95	4,82	5,50	6,71
	065605 *		065612 *		065629 *		065636 *		065643 *	
Pakiranje v kos	25		25		25		25		20	
Pakiranje v kos	1 000		1 000		1 000		1 000		800	

* Izdelava po meri

VOGALNIK NOTRANJI

P-PRA

Nominalna velikost	200		250		280		333		400	
	Brez DDV	Z DDV	Brez DDV	Z DDV	Brez DDV	Z DDV	Brez DDV	Z DDV	Brez DDV	Z DDV
TM 1 Testa di Moro RAL 8028	11,90	14,52	11,70	14,27	11,80	14,40	11,90	14,52	29,90	36,48
	075673		075680		075697		075703		075710	
AN 2 Antracit RAL 7016	11,90	14,52	11,70	14,27	11,80	14,40	11,90	14,52	29,90	36,48
	075178		075185		075192		075208		075215	
IC 3 Črna intenzivno RAL 9005	11,90	14,52	11,70	14,27	11,80	14,40	11,90	14,52	29,90	36,48
	075260		075284		075291		075307		075314	
OC 4 Vinsko rdeča RAL 3009	11,90	14,52	11,70	14,27	11,80	14,40	11,90	14,52	29,90	36,48
	075529		075536		075543		075567		075550	
MH 5 Opečno rdeča RAL 8004	11,90	14,52	11,70	14,27	11,80	14,40	11,90	14,52	29,90	36,48
	075321		075338		075345		075352		075369	
SB 6 Umazano bela RAL 9002	11,90	14,52	11,70	14,27	11,80	14,40	11,90	14,52	29,90	36,48
	075635		075628		075642		075659		075666	
BH 7 Srebrna RAL 9006	11,90	14,52	11,70	14,27	11,80	14,40	11,90	14,52	29,90	36,48
	075222		075239		075246		075253		075277	
PS 8 Prašno siva RAL 7037	11,90	14,52	11,70	14,27	11,80	14,40	11,90	14,52	29,90	36,48
	075574		075581		075598		075604		075611	
MM 9 Metalik bakrena RAL extra	11,90	14,52	11,70	14,27	11,80	14,40	11,90	14,52	29,90	36,48
	075376		075383		075390		075406		075413	
BHT – P.20 10 Temno srebrna RAL 9007			11,70	14,27	11,80	14,40	11,90	14,52	29,90	36,48
			094384		094391 *		094407		110695	
MZ 11 Zelena mahovo RAL 6005	11,90	14,52	11,70	14,27	11,80	14,40	11,90	14,52	29,90	36,48
	075475		075482		075499		075505		075512	
MOT 12 Temno modra RAL 5010	11,90	14,52	11,70	14,27	11,80	14,40	11,90	14,52	29,90	36,48
	075420		075437		075444		075451		075468	
TZ 13 Zelena svetlo RAL 6011	11,90	14,52	11,70	14,27	11,80	14,40	11,90	14,52	29,90	36,48
	075727 *		075734		075741		075758		075765 *	
Pakiranje v kos 	5		5		5		5		5	
Pakiranje v kos 	150		150		150		150		150	

* Izdelava po meri

POCINKANO
POLYESTER



VOGALNIK ZUNANJI

P-PRI



Nominalna velikost	200		250		280		333		400	
	Brez DDV	Z DDV	Brez DDV	Z DDV	Brez DDV	Z DDV	Brez DDV	Z DDV	Brez DDV	Z DDV
TM 1 Testa di Moro RAL 8028	11,90	14,52	11,70	14,27	11,80	14,40	11,90	14,52	29,90	36,48
	076281		076274		076298		076304		076311	
AN 2 Antracit RAL 7016	11,90	14,52	11,70	14,27	11,80	14,40	11,90	14,52	29,90	36,48
	075772		075789		075796		075802		075819	
IC 3 Črna intenzivno RAL 9005	11,90	14,52	11,70	14,27	11,80	14,40	11,90	14,52	29,90	36,48
	075871		075888		075895		075901		075918	
OC 4 Vinsko rdeča RAL 3009	11,90	14,52	11,70	14,27	11,80	14,40	11,90	14,52	29,90	36,48
	076120		076137		076144		076168		076151	
MH 5 Opečno rdeča RAL 8004	11,90	14,52	11,70	14,27	11,80	14,40	11,90	14,52	29,90	36,48
	075925		075932		075949		075956		075963	
SB 6 Umazano bela RAL 9002	11,90	14,52	11,70	14,27	11,80	14,40	11,90	14,52	29,90	36,48
	076229		076236		076243		076250		076267	
BH 7 Srebrna RAL 9006	11,90	14,52	11,70	14,27	11,80	14,40	11,90	14,52	29,90	36,48
	075826		075833		075840		075857		075864	
PS 8 Prašno siva RAL 7037	11,90	14,52	11,70	14,27	11,80	14,40	11,90	14,52	29,90	36,48
	076175		076199		076182		076205		076212	
MM 9 Metalik bakrena RAL extra	11,90	14,52	11,70	14,27	11,80	14,40	11,90	14,52	29,90	36,48
	075970		075987		075994		076007		076014	
BHT – P.20 10 Temno srebrna RAL 9007			11,70	14,27	11,80	14,40	11,90	14,52	29,90	36,48
			094414		094421 *		094438		110688	
MZ 11 Zelena mahovo RAL 6005	11,90	14,52	11,70	14,27	11,80	14,40	11,90	14,52	29,90	36,48
	076076		076083		076090		076106		076113	
MOT 12 Temno modra RAL 5010	11,90	14,52	11,70	14,27	11,80	14,40	11,90	14,52	29,90	36,48
	076021 *		076038		076045		076052		076069	
TZ 13 Zelena svetlo RAL 6011	11,90	14,52	11,70	14,27	11,80	14,40	11,90	14,52	29,90	36,48
	076335 *		076328		076342		076359		076366 *	
Pakiranje v kos 	5		5		5		5		5	
Pakiranje v kos 	150		150		150		150		150	

* Izdelava po meri



ZAKLJUČEK ŽLEBA

P-PCL



Nominalna velikost	200		250		280		333		400	
	Brez DDV	Z DDV	Brez DDV	Z DDV	Brez DDV	Z DDV	Brez DDV	Z DDV	Brez DDV	Z DDV
TM 1 Testa di Moro RAL 8028	1,45	1,77	1,30	1,59	1,40	1,71	1,45	1,77	2,25	2,75
	003164		003171		003188		003195		003201	
AN 2 Antracit RAL 7016	1,45	1,77	1,30	1,59	1,40	1,71	1,45	1,77	2,25	2,75
	002662		002679		002686		002693		002709	
IC 3 Črna intenzivno RAL 9005	1,45	1,77	1,30	1,59	1,40	1,71	1,45	1,77	2,25	2,75
	002761		002778		002785		002792		002808	
OC 4 Vinsko rdeča RAL 3009	1,45	1,77	1,30	1,59	1,40	1,71	1,45	1,77	2,25	2,75
	003010		003027		003034		003041		003058	
MH 5 Opečno rdeča RAL 8004	1,45	1,77	1,30	1,59	1,40	1,71	1,45	1,77	2,25	2,75
	002815		002822		002839		002846		002853	
SB 6 Umazano bela RAL 9002	1,45	1,77	1,30	1,59	1,40	1,71	1,45	1,77	2,25	2,75
	003119		003126		003133		003140		003157	
BH 7 Srebrna RAL 9006	1,45	1,77	1,30	1,59	1,40	1,71	1,45	1,77	2,25	2,75
	002716		002723		002730		002747		002754	
PS 8 Prašno siva RAL 7037	1,45	1,77	1,30	1,59	1,40	1,71	1,45	1,77	2,25	2,75
	003065		003072		003089		003096		003102	
MM 9 Metalik bakrena RAL extra	1,45	1,77	1,30	1,59	1,40	1,71	1,45	1,77	2,25	2,75
	002860		002877		002884		002891		002907	
BHT – P.20 10 Temno srebrna RAL 9007			1,30	1,59	1,40	1,71	1,45	1,77	2,25	2,75
			094568		094575 *		094582		094599	
MZ 11 Zelena mahovo RAL 6005	1,45	1,77	1,30	1,59	1,40	1,71	1,45	1,77	2,25	2,75
	002969		002976		002983		002990		003003	
MOT 12 Temno modra RAL 5010	1,45	1,77	1,30	1,59	1,40	1,71	1,45	1,77	2,25	2,75
	002914		002921		002938		002945		002952	
TZ 13 Zelena svetlo RAL 6011	1,45	1,77	1,30	1,59	1,40	1,71	1,45	1,77	2,25	2,75
	003218 *		003225		003232		003249		003256	
Pakiranje v kos 	6/60		6/60		6/60		6/60		4/40	
Pakiranje v kos 	1 440		1 440		1 440		1 440		960	

* Izdelava po meri



ZAKLJUČEK Z GUMO

P-PCLG



Nominalna velikost	250		280		333	
	Brez DDV	Z DDV	Brez DDV	Z DDV	Brez DDV	Z DDV
TM 1 Testa di Moro RAL 8028	2,65	3,23	2,90	3,54	3,00	3,66
	004338		004345		004352	
AN 2 Antracit RAL 7016	2,65	3,23	2,90	3,54	3,00	3,66
	004031		004048		004055	
IC 3 Črna intenzivno RAL 9005	2,65	3,23	2,90	3,54	3,00	3,66
	004093		004109		004116	
OC 4 Vinsko rdeča RAL 3009	2,65	3,23	2,90	3,54	3,00	3,66
	004246		004253		004260	
MH 5 Opečno rdeča RAL 8004	2,65	3,23	2,90	3,54	3,00	3,66
	004123		004130		004147	
SB 6 Umazano bela RAL 9002	2,65	3,23	2,90	3,54	3,00	3,66
	004307		004314		004321	
BH 7 Srebrna RAL 9006	2,65	3,23	2,90	3,54	3,00	3,66
	004062		004079		004086	
PS 8 Prašno siva RAL 7037	2,65	3,23	2,90	3,54	3,00	3,66
	004277		004284		004291	
MM 9 Metalik bakrena RAL extra	2,65	3,23	2,90	3,54	3,00	3,66
	004154		004161		004178	
BHT – P.20 10 Temno srebrna RAL 9007	2,65	3,23	2,90	3,54	3,00	3,66
	094605		094612 *		094629	
MZ 11 Zelena mahovo RAL 6005	2,65	3,23	2,90	3,54	3,00	3,66
	004215		004222		004239	
MOT 12 Temno modra RAL 5010	2,65	3,23	2,90	3,54	3,00	3,66
	004185		004192		004208	
TZ 13 Zelena svetlo RAL 6011	2,65	3,23	2,90	3,54	3,00	3,66
	004369 *		004376 *		004383 *	
Pakiranje v kos 	4/40		4/40		4/40	
Pakiranje v kos 	960		960		960	

* Izdelava po meri



KOTLIČEK

P-PKL

Nominalna velikost	200/60		250/60		250/80		280/80		280/100	
	Brez DDV	Z DDV	Brez DDV	Z DDV	Brez DDV	Z DDV	Brez DDV	Z DDV	Brez DDV	Z DDV
TM 1 Testa di Moro RAL 8028	7,40	9,03	9,00	10,98	6,60	8,05	7,20	8,78	7,20	8,78
	067357		067364		067371		067388		067395	
AN 2 Antracit RAL 7016	7,40	9,03	9,00	10,98	6,60	8,05	7,20	8,78	7,20	8,78
	066251		066268		066275		066282		066299	
IC 3 Črna intenzivno RAL 9005	7,40	9,03	9,00	10,98	6,60	8,05	7,20	8,78	7,20	8,78
	066473		066480		066497		066503		066510	
OC 4 Vinsko rdeča RAL 3009	7,40	9,03	9,00	10,98	6,60	8,05	7,20	8,78	7,20	8,78
	067029		067036		067043		067050		067067	
MH 5 Opečno rdeča RAL 8004	7,40	9,03	9,00	10,98	6,60	8,05	7,20	8,78	7,20	8,78
	066589		066596		066602		066619		066626	
SB 6 Umazano bela RAL 9002	7,40	9,03	9,00	10,98	6,60	8,05	7,20	8,78	7,20	8,78
	067241		067258		067265		067272		067289	
BH 7 Srebrna RAL 9006	7,40	9,03	9,00	10,98	6,60	8,05	7,20	8,78	7,20	8,78
	066367		066374		066381		066398		066404	
PS 8 Prašno siva RAL 7037	7,40	9,03	9,00	10,98	6,60	8,05	7,20	8,78	7,20	8,78
	067135		067142 *		067159		067166		067173	
MM 9 Metalik bakrena RAL extra	7,40	9,03	9,00	10,98	6,60	8,05	7,20	8,78	7,20	8,78
	066695		066701 *		066718		066725		066732	
BHT – P.20 10 Temno srebrna RAL 9007	7,40	9,03	9,00	10,98	6,60	8,05	7,20	8,78	7,20	8,78
	119728 *		119735 *		094469		094476		094483	
MZ 11 Zelena mahovo RAL 6005	7,40	9,03	9,00	10,98	6,60	8,05	7,20	8,78	7,20	8,78
	066916		066923		066930		066947		066954	
MOT 12 Temno modra RAL 5010	7,40	9,03	9,00	10,98	6,60	8,05	7,20	8,78	7,20	8,78
	066800 *		066817 *		066824		066831		066848	
TZ 13 Zelena svetlo RAL 6011	7,40	9,03	9,00	10,98	6,60	8,05	7,20	8,78	7,20	8,78
	067463 *		067470 *		067487		067494 *		067500	
Pakiranje v kos 	20		20		20		20		20	
Pakiranje v kos 	600		600		600		600		600	

* Izdelava po meri



KOTLIČEK

P-PKL



Nominalna velikost	333/80		333/100		333/120	
	Brez DDV	Z DDV	Brez DDV	Z DDV	Brez DDV	Z DDV
TM 1 Testa di Moro RAL 8028	8,40	10,25	7,95	9,70	9,50	11,59
	067401		067418		067425	
AN 2 Antracit RAL 7016	8,40	10,25	7,95	9,70	9,50	11,59
	066305		066312		066329	
IC 3 Črna intenzivno RAL 9005	8,40	10,25	7,95	9,70	9,50	11,59
	066527		066534		066541	
OC 4 Vinsko rdeča RAL 3009	8,40	10,25	7,95	9,70	9,50	11,59
	067074		067081		067098	
MH 5 Opečno rdeča RAL 8004	8,40	10,25	7,95	9,70	9,50	11,59
	066633		066640		066657	
SB 6 Umazano bela RAL 9002	8,40	10,25	7,95	9,70	9,50	11,59
	067296		067302		067326	
BH 7 Srebrna RAL 9006	8,40	10,25	7,95	9,70	9,50	11,59
	066411		066428		066435	
PS 8 Prašno siva RAL 7037	8,40	10,25	7,95	9,70	9,50	11,59
	067180		067197		067203	
MM 9 Metalik bakrena RAL extra	8,40	10,25	7,95	9,70	9,50	11,59
	066749		066756		066763	
BHT – P.20 10 Temno srebrna RAL 9007	8,40	10,25	7,95	9,70	9,50	11,59
	094490 *		094506		094513	
MZ 11 Zelena mahovo RAL 6005	8,40	10,25	7,95	9,70	9,50	11,59
	066961		066978		066985	
MOT 12 Temno modra RAL 5010	8,40	10,25	7,95	9,70	9,50	11,59
	066855 *		066862		066879	
TZ 13 Zelena svetlo RAL 6011	8,40	10,25	7,95	9,70	9,50	11,59
	067517 *		067524		067531	
Pakiranje v kos	20		20		15	
Pakiranje v kos	600		600		300	

* Izdelava po meri

KOTLIČEK

P-PKL

Nominalna velikost	400/100		400/120		400/150	
	Brez DDV	Z DDV	Brez DDV	Z DDV	Brez DDV	Z DDV
TM 1 Testa di Moro RAL 8028	19,00	23,18	19,00	23,18	21,50	26,23
	067432		067449		067456	
AN 2 Antracit RAL 7016	19,00	23,18	19,00	23,18	21,50	26,23
	066336		066343		066350	
IC 3 Črna intenzivno RAL 9005	19,00	23,18	19,00	23,18	21,50	26,23
	066558		066565		066572	
OC 4 Vinsko rdeča RAL 3009	19,00	23,18	19,00	23,18	21,50	26,23
	067104 *		067111		067128	
MH 5 Opečno rdeča RAL 8004	19,00	23,18	19,00	23,18	21,50	26,23
	066664 *		066671		066688	
SB 6 Umazano bela RAL 9002	19,00	23,18	19,00	23,18	21,50	26,23
	067319		067333		067340	
BH 7 Srebrna RAL 9006	19,00	23,18	19,00	23,18	21,50	26,23
	066442		066459		066466	
PS 8 Prašno siva RAL 7037	19,00	23,18	19,00	23,18	21,50	26,23
	067210		067227		067234	
MM 9 Metalik bakrena RAL extra	19,00	23,18	19,00	23,18	21,50	26,23
	066770 *		066787 *		066794 *	
BHT – P.20 10 Temno srebrna RAL 9007	19,00	23,18	19,00	23,18	21,50	26,23
	119742 *		094520		094667	
MZ 11 Zelena mahovo RAL 6005	19,00	23,18	19,00	23,18	21,50	26,23
	066992 *		067005		067012	
MOT 12 Temno modra RAL 5010	19,00	23,18	19,00	23,18	21,50	26,23
	066886 *		066893		066909	
TZ 13 Zelena svetlo RAL 6011	19,00	23,18	19,00	23,18	21,50	26,23
	067548 *		067555		067562 *	
Pakiranje v kos 	15		15		15	
Pakiranje v kos 	300		300		300	

* Izdelava po meri



POCINKANO POLYESTER

NOV PRIČVRSTILNI
SISTEM FEDER OMOGOČA
LAHKO OBRAČANJE KOLENA
DO ŽELJENE SMERI IN OSTANE
FIKSIRANO V VSAKI POZICIJI.
ENOSTAVNA MONTAŽA NA
BILO KATERO KOLENO
BREZ KOVIČENJA.

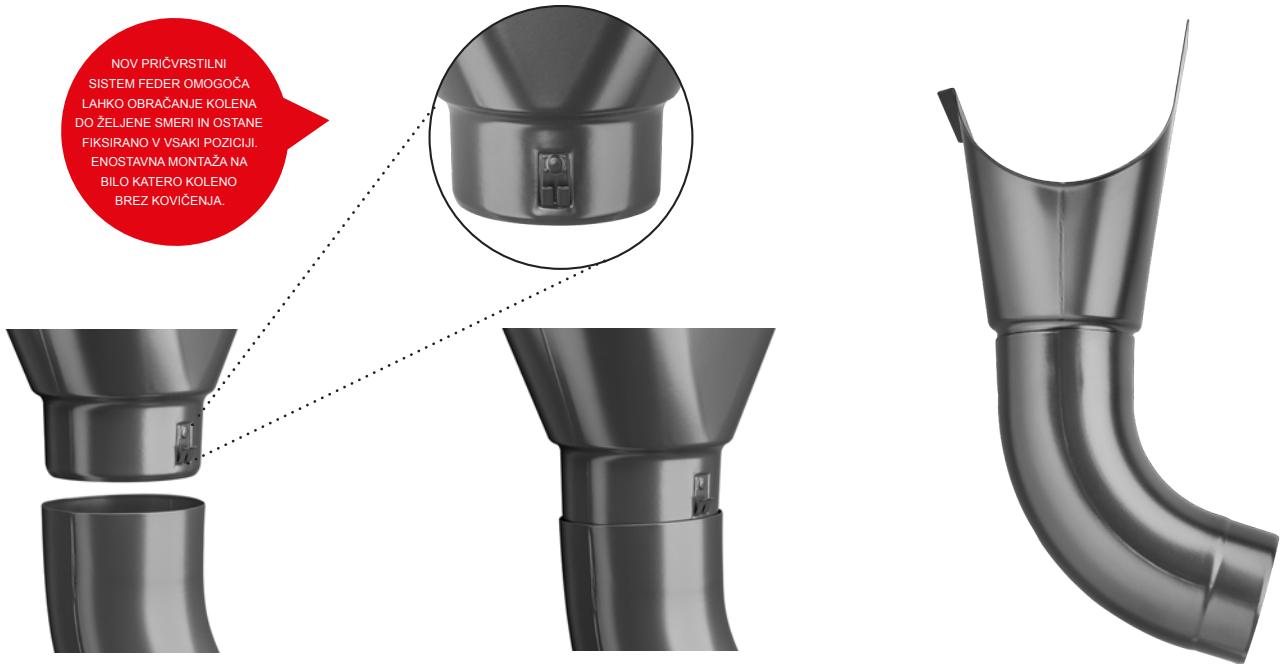

POCINKANO
POLYESTER



ZBIRNI KOTLIČEK CENTRALNI

IT-KLZF C

Nominalna velikost	60		80		100		120	
Cena v €/kos	Brez DDV		Brez DDV		Brez DDV		Brez DDV	
TM 1 Testa di Moro RAL 8028	14,90	18,18	15,00	18,30	16,20	19,76	21,60	26,35
	077028 *		077042 *		077066 *		077080 *	
AN 2 Antracit RAL 7016	14,90	18,18	15,00	18,30	16,20	19,76	21,60	26,35
	076540 *		076564 *		076588 *		076601 *	
IC 3 Črna intenzivno RAL 9005	14,90	18,18	15,00	18,30	16,20	19,76	21,60	26,35
	076700 *		076724 *		076748 *		076762 *	
OC 4 Vinsko rdeča RAL 3009	14,90	18,18	15,00	18,30	16,20	19,76	21,60	26,35
	076861 *		076885 *		076908 *		076922 *	
MH 5 Opečno rdeča RAL 8004	14,90	18,18	15,00	18,30	16,20	19,76	21,60	26,35
	076786 *		076809 *		076823 *		076847 *	
SB 6 Umazano bela RAL 9002	14,90	18,18	15,00	18,30	16,20	19,76	21,60	26,35
	076946 *		076960 *		076984 *		077004 *	
BH 7 Srebrna RAL 9006	14,90	18,18	15,00	18,30	16,20	19,76	21,60	26,35
	076625 *		076649 *		076663 *		076687 *	
PS 8 Prašno siva RAL 7037								
MM 9 Metalik bakrena RAL extra								
BHT – P.20 10 Temno srebrna RAL 9007								
MZ 11 Zelena mahovo RAL 6005								
MOT 12 Temno modra RAL 5010								
TZ 13 Zelena svetlo RAL 6011								
Pakiranje v kos 	10		10		10		10	
Pakiranje v kos 	300		300		200		200	

* Izdelava po meri



ZBIRNI KOTLIČEK STRANSKI

IT-KLZF B





Nominalna velikost	60		80		100		120	
Cena v €/kos	Brez DDV		Brez DDV		Brez DDV		Brez DDV	
TM 1 Testa di Moro RAL 8028	14,90	18,18	15,00	18,30	16,20	19,76	21,60	26,35
	077011 *		077035 *		077059 *		077073 *	
AN 2 Antracit RAL 7016	14,90	18,18	15,00	18,30	16,20	19,76	21,60	26,35
	076533 *		076557 *		076571 *		076595 *	
IC 3 Črna intenzivno RAL 9005	14,90	18,18	15,00	18,30	16,20	19,76	21,60	26,35
	076694 *		076717 *		076731 *		076755 *	
OC 4 Vinsko rdeča RAL 3009	14,90	18,18	15,00	18,30	16,20	19,76	21,60	26,35
	076854 *		076878 *		076892 *		076915 *	
MH 5 Opečno rdeča RAL 8004	14,90	18,18	15,00	18,30	16,20	19,76	21,60	26,35
	076779 *		076793 *		076816 *		076830 *	
SB 6 Umazano bela RAL 9002	14,90	18,18	15,00	18,30	16,20	19,76	21,60	26,35
	076939 *		076953 *		076977 *		076991 *	
BH 7 Srebrna RAL 9006	14,90	18,18	15,00	18,30	16,20	19,76	21,60	26,35
	076618 *		076632 *		076656 *		076670 *	
PS 8 Prašno siva RAL 7037								
MM 9 Metalik bakrena RAL extra								
BHT – P.20 10 Temno srebrna RAL 9007								
MZ 11 Zelena mahovo RAL 6005								
MOT 12 Temno modra RAL 5010								
TZ 13 Zelena svetlo RAL 6011								
Pakiranje v kos	10		10		10		10	
Pakiranje v kos	300		300		200		200	

* Izdelava po meri

GRLO ZA STREŠNI ŽLEB

P-PHRD

Nominalna velikost	80		100		120	
	Brez DDV	Z DDV	Brez DDV	Z DDV	Brez DDV	Z DDV
TM 1 Testa di Moro RAL 8028	1,80	2,20	1,90	2,32	2,30	2,81
	066015		066022		066039	
AN 2 Antracit RAL 7016	1,80	2,20	1,90	2,32	2,30	2,81
	065711		065728		065735 *	
IC 3 Črna intenzivno RAL 9005	1,80	2,20	1,90	2,32	2,30	2,81
	065773 *		065780		065797 *	
OC 4 Vinsko rdeča RAL 3009	1,80	2,20	1,90	2,32	2,30	2,81
	065926 *		065933		065940 *	
MH 5 Opečno rdeča RAL 8004	1,80	2,20	1,90	2,32	2,30	2,81
	065803 *		065810		065827 *	
SB 6 Umazano bela RAL 9002	1,80	2,20	1,90	2,32	2,30	2,81
	065988 *		065995 *		066008 *	
BH 7 Srebrna RAL 9006	1,80	2,20	1,90	2,32	2,30	2,81
	065742 *		065759 *		065766 *	
PS 8 Prašno siva RAL 7037	1,80	2,20	1,90	2,32	2,30	2,81
	065957 *		065964 *		065971 *	
MM 9 Metalik bakrena RAL extra	1,80	2,20	1,90	2,32	2,30	2,81
	065834 *		065841 *		065858 *	
BHT – P.20 10 Temno srebrna RAL 9007						
MZ 11 Zelena mahovo RAL 6005	1,80	2,20	1,90	2,32	2,30	2,81
	065896 *		065902 *		065919 *	
MOT 12 Temno modra RAL 5010	1,80	2,20	1,90	2,32	2,30	2,81
	065865 *		065872 *		065889 *	
TZ 13 Zelena svetlo RAL 6011	1,80	2,20	1,90	2,32	2,30	2,81
	066046 *		066053 *		066060 *	
Pakiranje v kos 	25		25		15	
Pakiranje v kos 	1 000		1 000		750	

* Izdelava po meri





POCINKANO POLYESTER

INOX LOVILEC NESNAGE

N-NZN





Nominalna velikost	EAN številko izdelka	Pakiranje v kos		Cena [€/kos]	
				Brez DDV	Z DDV
60	001153	30	2 160	5,55	6,77
80	001160	20	1 440	5,60	6,83
100	001177	15	1 080	5,70	6,95
120	001184	10	720	6,20	7,56
150	001191	5	360	9,80	11,96



ZBIRNI KOTLIČEK DESIGN

P-PKLZ DE

Nominalna velikost	80		100		120	
	Brez DDV	Z DDV	Brez DDV	Z DDV	Brez DDV	Z DDV
TM 1 Testa di Moro RAL 8028	58,00	70,76	58,00	70,76	64,00	78,08
	027702		027726		027740	
AN 2 Antracit RAL 7016	58,00	70,76	58,00	70,76	64,00	78,08
	026200		026224		026248	
IC 3 Črna intenzivno RAL 9005	58,00	70,76	58,00	70,76	64,00	78,08
	026507		026521		026545	
OC 4 Vinsko rdeča RAL 3009	58,00	70,76	58,00	70,76	64,00	78,08
	027252 *		027276		027290	
MH 5 Opečno rdeča RAL 8004	58,00	70,76	58,00	70,76	64,00	78,08
	026651		026675		026699	
SB 6 Umazano bela RAL 9002	58,00	70,76	58,00	70,76	64,00	78,08
	027559 *		027573		027597	
BH 7 Srebrna RAL 9006	58,00	70,76	58,00	70,76	64,00	78,08
	026354		026378		026392	
PS 8 Prašno siva RAL 7037	58,00	70,76	58,00	70,76	64,00	78,08
	027405		027429		027443	
MM 9 Metalik bakrena RAL extra	58,00	70,76	58,00	70,76	64,00	78,08
	026804 *		026828		026842	
BHT – P.20 10 Temno srebrna RAL 9007	58,00	70,76	58,00	70,76	64,00	78,08
	096210		096265		096319	
MZ 11 Zelena mahovo RAL 6005	58,00	70,76	58,00	70,76	64,00	78,08
	027108 *		027122		027146 *	
MOT 12 Temno modra RAL 5010	58,00	70,76	58,00	70,76	64,00	78,08
	026958 *		026972		027009 *	
TZ 13 Zelena svetlo RAL 6011	58,00	70,76	58,00	70,76	64,00	78,08
	027856 *		027870 *		027894 *	
Pakiranje v kos 	2		2		2	
Pakiranje v kos 	36		36		36	

* Izdelava po meri



ZBIRNI KOTLIČEK DESIGN EKSCENTRIČE

P-PKLZ DX



Nominalna velikost	80		100		120	
	Brez DDV	Z DDV	Brez DDV	Z DDV	Brez DDV	Z DDV
TM 1 Testa di Moro RAL 8028	72,00	87,84	72,00	87,84	74,00	90,28
	027764		027795		027825	
AN 2 Antracit RAL 7016	72,00	87,84	72,00	87,84	74,00	90,28
	026262		026293		026323	
IC 3 Črna intenzivno RAL 9005	72,00	87,84	72,00	87,84	74,00	90,28
	026569		026590		026620 *	
OC 4 Vinsko rdeča RAL 3009	72,00	87,84	72,00	87,84	74,00	90,28
	027313		027344		027375 *	
MH 5 Opečno rdeča RAL 8004	72,00	87,84	72,00	87,84	74,00	90,28
	026712 *		026743 *		026774 *	
SB 6 Umazano bela RAL 9002	72,00	87,84	72,00	87,84	74,00	90,28
	027610 *		027641		027672	
BH 7 Srebrna RAL 9006	72,00	87,84	72,00	87,84	74,00	90,28
	026415 *		026446		026477	
PS 8 Prašno siva RAL 7037	72,00	87,84	72,00	87,84	74,00	90,28
	027467 *		027498		027528	
MM 9 Metalik bakrena RAL extra	72,00	87,84	72,00	87,84	74,00	90,28
	026866 *		026897		026927 *	
BHT – P.20 10 Temno srebrna RAL 9007	72,00	87,84	72,00	87,84	74,00	90,28
	096203 *		096258		096302	
MZ 11 Zelena mahovo RAL 6005	72,00	87,84	72,00	87,84	74,00	90,28
	027160 *		027191 *		027221 *	
MOT 12 Temno modra RAL 5010	72,00	87,84	72,00	87,84	74,00	90,28
	027016 *		027047 *		027078 *	
TZ 13 Zelena svetlo RAL 6011	72,00	87,84	72,00	87,84	74,00	90,28
	027917 *		027948 *		027979 *	
Pakiranje v kos	2		2		2	
Pakiranje v kos	36		36		36	

* Izdelava po meri

ZBIRNI KOTLIČEK KUBICKI

P-PKLZ KU



Nominalna velikost	80		100		120	
	Brez DDV	Z DDV	Brez DDV	Z DDV	Brez DDV	Z DDV
TM 1 Testa di Moro RAL 8028	88,00	107,36	88,00	107,36	94,00	114,68
	027719 *		027733		027757	
AN 2 Antracit RAL 7016	88,00	107,36	88,00	107,36	94,00	114,68
	026217		026231		026255	
IC 3 Črna intenzivno RAL 9005	88,00	107,36	88,00	107,36	94,00	114,68
	026514		026538		026552	
OC 4 Vinsko rdeča RAL 3009	88,00	107,36	88,00	107,36	94,00	114,68
	027269 *		027283 *		027306	
MH 5 Opečno rdeča RAL 8004	88,00	107,36	88,00	107,36	94,00	114,68
	026668 *		026682 *		026705 *	
SB 6 Umazano bela RAL 9002	88,00	107,36	88,00	107,36	94,00	114,68
	027566 *		027580 *		027603 *	
BH 7 Srebrna RAL 9006	88,00	107,36	88,00	107,36	94,00	114,68
	026361 *		026385		026408	
PS 8 Prašno siva RAL 7037	88,00	107,36	88,00	107,36	94,00	114,68
	027412 *		027436 *		027450	
MM 9 Metalik bakrena RAL extra	88,00	107,36	88,00	107,36	94,00	114,68
	026811 *		026835 *		026859 *	
BHT – P.20 10 Temno srebrna RAL 9007	88,00	107,36	88,00	107,36	94,00	114,68
	096241 *		096296 *		096340 *	
MZ 11 Zelena mahovo RAL 6005	88,00	107,36	88,00	107,36	94,00	114,68
	027115 *		027139 *		027153 *	
MOT 12 Temno modra RAL 5010	88,00	107,36	88,00	107,36	94,00	114,68
	026965 *		026989 *		026996 *	
TZ 13 Zelena svetlo RAL 6011	88,00	107,36	88,00	107,36	94,00	114,68
	027863 *		027887 *		027900 *	
Pakiranje v kos 	2		2		2	
Pakiranje v kos 	36		36		36	

* Izdelava po meri

ZBIRNI KOTLIČEK KUBICKI EKSCENTRIČEN

P-PKLZ KX





Nominalna velikost	80		100		120	
	Brez DDV	Z DDV	Brez DDV	Z DDV	Brez DDV	Z DDV
TM 1 Testa di Moro RAL 8028	88,00	107,36	88,00	107,36	94,00	114,68
	027788		027818		027849	
AN 2 Antracit RAL 7016	88,00	107,36	88,00	107,36	94,00	114,68
	026286		026316		026347	
IC 3 Črna intenzivno RAL 9005	88,00	107,36	88,00	107,36	94,00	114,68
	026583		026613		026644 *	
OC 4 Vinsko rdeča RAL 3009	88,00	107,36	88,00	107,36	94,00	114,68
	027337 *		027368		027399	
MH 5 Opečno rdeča RAL 8004	88,00	107,36	88,00	107,36	94,00	114,68
	026736		026767		026798 *	
SB 6 Umazano bela RAL 9002	88,00	107,36	88,00	107,36	94,00	114,68
	027634 *		027665		027696	
BH 7 Srebrna RAL 9006	88,00	107,36	88,00	107,36	94,00	114,68
	026439 *		026460		026491	
PS 8 Prašno siva RAL 7037	88,00	107,36	88,00	107,36	94,00	114,68
	027481 *		027511		027542	
MM 9 Metalik bakrena RAL extra	88,00	107,36	88,00	107,36	94,00	114,68
	026880 *		026910		026941 *	
BHT – P.20 10 Temno srebrna RAL 9007	88,00	107,36	88,00	107,36	94,00	114,68
	096227		096272		096326	
MZ 11 Zelena mahovo RAL 6005	88,00	107,36	88,00	107,36	94,00	114,68
	027184 *		027214		027245 *	
MOT 12 Temno modra RAL 5010	88,00	107,36	88,00	107,36	94,00	114,68
	027030 *		027061 *		027092 *	
TZ 13 Zelena svetlo RAL 6011	88,00	107,36	88,00	107,36	94,00	114,68
	027931 *		027962		027993 *	
Pakiranje v kos 	2		2		2	
Pakiranje v kos 	36		36		36	

* Izdelava po meri

ZBIRNI KOTLIČEK KUBICKI EKSCENTRIČEN ISPUSTOM P-PKLZ KXV



Nominalna velikost	80		100		120	
	Brez DDV	Z DDV	Brez DDV	Z DDV	Brez DDV	Z DDV
TM 1 Testa di Moro RAL 8028	115,00	140,30	115,00	140,30	115,00	140,30
	027771 *		027801 *		027832 *	
AN 2 Antracit RAL 7016	115,00	140,30	115,00	140,30	115,00	140,30
	026279 *		026309 *		026330 *	
IC 3 Črna intenzivno RAL 9005	115,00	140,30	115,00	140,30	115,00	140,30
	026576 *		026606		026637 *	
OC 4 Vinsko rdeča RAL 3009	115,00	140,30	115,00	140,30	115,00	140,30
	027320 *		027351 *		027382 *	
MH 5 Opečno rdeča RAL 8004	115,00	140,30	115,00	140,30	115,00	140,30
	026729 *		026750 *		026781 *	
SB 6 Umazano bela RAL 9002	115,00	140,30	115,00	140,30	115,00	140,30
	027627 *		027658 *		027689 *	
BH 7 Srebrna RAL 9006	115,00	140,30	115,00	140,30	115,00	140,30
	026422 *		026453 *		026484 *	
PS 8 Prašno siva RAL 7037	115,00	140,30	115,00	140,30	115,00	140,30
	027474 *		027504 *		027535 *	
MM 9 Metalik bakrena RAL extra	115,00	140,30	115,00	140,30	115,00	140,30
	026873 *		026903 *		026934 *	
BHT – P.20 10 Temno srebrna RAL 9007	115,00	140,30	115,00	140,30	115,00	140,30
	096234 *		096289 *		096333 *	
MZ 11 Zelena mahovo RAL 6005	115,00	140,30	115,00	140,30	115,00	140,30
	027177 *		027207 *		027238 *	
MOT 12 Temno modra RAL 5010	115,00	140,30	115,00	140,30	115,00	140,30
	027023 *		027054 *		027085 *	
TZ 13 Zelena svetlo RAL 6011	115,00	140,30	115,00	140,30	115,00	140,30
	027924 *		027955 *		027986 *	
Pakiranje v kos 	2		2		2	
Pakiranje v kos 	36		36		36	

* Izdelava po meri

TESNILNA GUMA ZBIRNEGA KOTLIČKA

P-PKLZ T



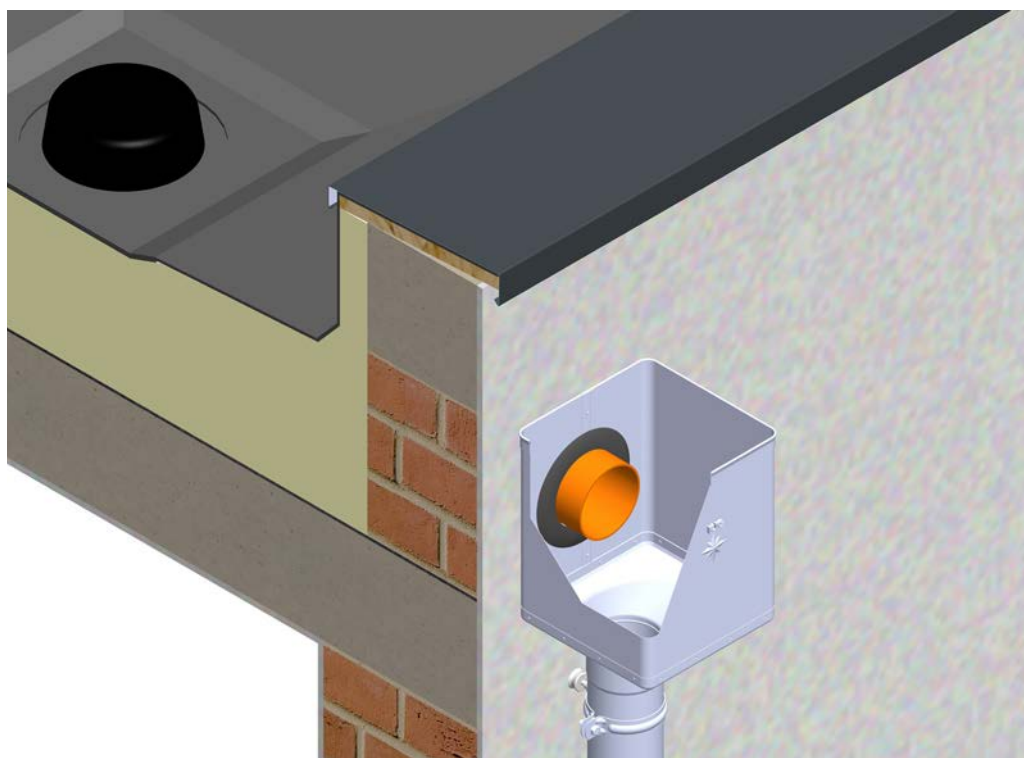

Nominalna velikost	EAN številko izdelka	Pakiranje v kos		Cena [€/kos]	
				Brez DDV	Z DDV
IC 70-85	077103	5	600	4,00	4,88
IC 100-110	077110	5	600	4,10	5,00
IC 110-125	077097	5	600	4,20	5,12
PS 70-85	077134	5	600	4,50	5,49
PS 100-110	077141	5	600	4,90	5,98
PS 110-125	077127	5	600	5,00	6,10



ODTOČNO KOLENO 72°

P-PK



Nominalna velikost	60		80		100		120		150	
	Brez DDV	Z DDV	Brez DDV	Z DDV	Brez DDV	Z DDV	Brez DDV	Z DDV	Brez DDV	Z DDV
TM 1 Testa di Moro RAL 8028	6,00	7,32	5,50	6,71	6,00	7,32	8,50	10,37	19,95	24,34
	072542		072559		072573		072597		033697	
AN 2 Antracit RAL 7016	6,00	7,32	5,50	6,71	6,00	7,32	8,50	10,37	19,95	24,34
	071842		071859		071873		071897		033598	
IC 3 Črna intenzivno RAL 9005	6,00	7,32	5,50	6,71	6,00	7,32	8,50	10,37	19,95	24,34
	071989		072023		072009		072030		033611	
OC 4 Vinsko rdeča RAL 3009	6,00	7,32	5,50	6,71	6,00	7,32	8,50	10,37	19,95	24,34
	072337		072344		072368		072382		033666	
MH 5 Opečno rdeča RAL 8004	6,00	7,32	5,50	6,71	6,00	7,32	8,50	10,37	19,95	24,34
	072054		072061		072085		072108		033628	
SB 6 Umazano bela RAL 9002	6,00	7,32	5,50	6,71	6,00	7,32	8,50	10,37	19,95	24,34
	072474		072481		072504		072528		033680	
BH 7 Srebrna RAL 9006	6,00	7,32	5,50	6,71	6,00	7,32	8,50	10,37	19,95	24,34
	071910		071927		071941		071965		033604	
PS 8 Prašno siva RAL 7037	6,00	7,32	5,50	6,71	6,00	7,32	8,50	10,37	19,95	24,34
	072405		072412		072429		072443		033673	
MM 9 Metalik bakrena RAL extra	6,00	7,32	5,50	6,71	6,00	7,32	8,50	10,37	19,95	24,34
	072122		072139		072153		072160		033635	
BHT – P.20 10 Temno srebrna RAL 9007	6,00	7,32	5,50	6,71	6,00	7,32	8,50	10,37	19,95	24,34
	118691 *		095183		095206		095220		095244	
MZ 11 Zelena mahovo RAL 6005	6,00	7,32	5,50	6,71	6,00	7,32	8,50	10,37	19,95	24,34
	072269		072276		072290		072313		033659	
MOT 12 Temno modra RAL 5010	6,00	7,32	5,50	6,71	6,00	7,32	8,50	10,37	19,95	24,34
	072191		072207		072221		072245		033642	
TZ 13 Zelena svetlo RAL 6011	6,00	7,32	5,50	6,71	6,00	7,32	8,50	10,37	19,95	24,34
	072610 *		072627		072641		072665		033703 *	
Pakiranje v kos 	25		25		25		15		5	
Pakiranje v kos 	600		400		300		180		90	

* Izdelava po meri



ODTOČNO KOLENO 85°

P-PKR



Nominalna velikost	80		100		120	
	Brez DDV	Z DDV	Brez DDV	Z DDV	Brez DDV	Z DDV
TM 1 Testa di Moro RAL 8028	6,90	8,42	7,80	9,52	12,40	15,13
	072566		072580		072603	
AN 2 Antracit RAL 7016	6,90	8,42	7,80	9,52	12,40	15,13
	071866		071880		071903	
IC 3 Črna intenzivno RAL 9005	6,90	8,42	7,80	9,52	12,40	15,13
	071996		072016		072047	
OC 4 Vinsko rdeča RAL 3009	6,90	8,42	7,80	9,52	12,40	15,13
	072351		072375		072399	
MH 5 Opečno rdeča RAL 8004	6,90	8,42	7,80	9,52	12,40	15,13
	072078		072092		072115	
SB 6 Umazano bela RAL 9002	6,90	8,42	7,80	9,52	12,40	15,13
	072498		072511		072535	
BH 7 Srebrna RAL 9006	6,90	8,42	7,80	9,52	12,40	15,13
	071934		071958		071972	
PS 8 Prašno siva RAL 7037	6,90	8,42	7,80	9,52	12,40	15,13
	072467		072436		072450	
MM 9 Metalik bakrena RAL extra	6,90	8,42	7,80	9,52	12,40	15,13
	072146		072184		072177	
BHT – P.20 10 Temno srebrna RAL 9007	6,90	8,42	7,80	9,52	12,40	15,13
	095190		095213		095237 *	
MZ 11 Zelena mahovo RAL 6005	6,90	8,42	7,80	9,52	12,40	15,13
	072283		072306		072320	
MOT 12 Temno modra RAL 5010	6,90	8,42	7,80	9,52	12,40	15,13
	072214 *		072238 *		072252 *	
TZ 13 Zelena svetlo RAL 6011	6,90	8,42	7,80	9,52	12,40	15,13
	072634 *		072658 *		072672 *	
Pakiranje v kos 	25		25		15	
Pakiranje v kos 	400		300		180	

* Izdelava po meri



ODTOČNO KOLENO 40°

P-PKT

Nominalna velikost	80		100		120	
	Brez DDV	Z DDV	Brez DDV	Z DDV	Brez DDV	Z DDV
TM 1 Testa di Moro RAL 8028	6,50	7,93	7,10	8,66	10,00	12,20
	072993		073006		073013	
AN 2 Antracit RAL 7016	6,50	7,93	7,10	8,66	10,00	12,20
	072696		072702		072719	
IC 3 Črna intenzivno RAL 9005	6,50	7,93	7,10	8,66	10,00	12,20
	072757		072764		072771	
OC 4 Vinsko rdeča RAL 3009	6,50	7,93	7,10	8,66	10,00	12,20
	072900		072917		072924	
MH 5 Opečno rdeča RAL 8004	6,50	7,93	7,10	8,66	10,00	12,20
	072795		072788		072801	
SB 6 Umazano bela RAL 9002	6,50	7,93	7,10	8,66	10,00	12,20
	072962		072979		072986	
BH 7 Srebrna RAL 9006	6,50	7,93	7,10	8,66	10,00	12,20
	072726		072733		072740	
PS 8 Prašno siva RAL 7037	6,50	7,93	7,10	8,66	10,00	12,20
	072931		072948		072955	
MM 9 Metalik bakrena RAL extra	6,50	7,93	7,10	8,66	10,00	12,20
	072818		072825		072832 *	
BHT – P.20 10 Temno srebrna RAL 9007	6,50	7,93	7,10	8,66	10,00	12,20
	094711		094728		094735	
MZ 11 Zelena mahovo RAL 6005	6,50	7,93	7,10	8,66	10,00	12,20
	072870 *		072887		072894	
MOT 12 Temno modra RAL 5010	6,50	7,93	7,10	8,66	10,00	12,20
	072849		072856		072863	
TZ 13 Zelena svetlo RAL 6011	6,50	7,93	7,10	8,66	10,00	12,20
	073020 *		073037 *		073044 *	
Pakiranje v kos 	25		25		15	
Pakiranje v kos 	400		300		240	

* Izdelava po meri



ZAKLJUČNO ODTOČNO KOLENO 72°

P-PKV



Nominalna velikost	80		100		120	
	Brez DDV	Z DDV	Brez DDV	Z DDV	Brez DDV	Z DDV
TM 1 Testa di Moro RAL 8028	6,50	7,93	7,00	8,54	9,50	11,59
	095046		095053		095060	
AN 2 Antracit RAL 7016	6,50	7,93	7,00	8,54	9,50	11,59
	094742		094759		094766	
IC 3 Črna intenzivno RAL 9005	6,50	7,93	7,00	8,54	9,50	11,59
	094803		094810		094827 *	
OC 4 Vinsko rdeča RAL 3009	6,50	7,93	7,00	8,54	9,50	11,59
	094957 *		094964		094971 *	
MH 5 Opečno rdeča RAL 8004	6,50	7,93	7,00	8,54	9,50	11,59
	094834		094841		094858	
SB 6 Umazano bela RAL 9002	6,50	7,93	7,00	8,54	9,50	11,59
	095015 *		095022		095039	
BH 7 Srebrna RAL 9006	6,50	7,93	7,00	8,54	9,50	11,59
	094773 *		094780		094797	
PS 8 Prašno siva RAL 7037	6,50	7,93	7,00	8,54	9,50	11,59
	094988 *		094995 *		095008 *	
MM 9 Metalik bakrena RAL extra	6,50	7,93	7,00	8,54	9,50	11,59
	094865 *		094872 *		094889 *	
BHT – P.20 10 Temno srebrna RAL 9007	6,50	7,93	7,00	8,54	9,50	11,59
	124739 *		124746 *		124753 *	
MZ 11 Zelena mahovo RAL 6005	6,50	7,93	7,00	8,54	9,50	11,59
	094926 *		094933 *		094940 *	
MOT 12 Temno modra RAL 5010	6,50	7,93	7,00	8,54	9,50	11,59
	094896 *		094902 *		094919 *	
TZ 13 Zelena svetlo RAL 6011	6,50	7,93	7,00	8,54	9,50	11,59
	095077 *		095084 *		095091 *	
Pakiranje v kos	25		25		15	
Pakiranje v kos	400		300		180	

* Izdelava po meri

POCINKANO POLYESTER

KOLENO FALCANO 72°

P-PKF2



Nominalna velikost	60		80		100		120	
Cena v €/kos	Brez DDV	Z DDV	Brez DDV	Z DDV	Brez DDV	Z DDV	Brez DDV	Z DDV
TM 1 Testa di Moro RAL 8028	4,30	5,25	3,40	4,15	4,40	5,37	6,30	7,69
	071781		071798		071811		071828	
Pakiranje v kos	10		10		10		8	
Pakiranje v kos	3 000		1 200		800		576	

KOLENO FALCANO 85°

P-PKF3



Nominalna velikost	80		100	
Cena v €/kos	Brez DDV	Z DDV	Brez DDV	Z DDV
TM 1 Testa di Moro RAL 8028	4,40	5,37	6,30	7,69
	071804		071835	
Pakiranje v kos	10		10	
Pakiranje v kos	1 200		800	

PVC CEVNA FOLIJA

SD-ZR FOLIA KJG



Nominalna velikost	Dolžina v m	EAN številko izdelka	Pakiranje v m		Cena [€/kos]	
					Brez DDV	Z DDV
60-150	100,0	139726	100	6 000	0,38	0,46

CEV ODVODNA [s=0,55]
P-PZR

Nominalna velikost	60		60		80		80		80	
Dolžina v m	2,0		3,0		1,0		2,0		3,0	
Cena v €/m	Brez DDV	Z DDV	Brez DDV	Z DDV	Brez DDV	Z DDV	Brez DDV	Z DDV	Brez DDV	Z DDV
TM 1 Testa di Moro RAL 8028	8,00	9,76	8,00	9,76	7,20	8,78	7,20	8,78	7,00	8,54
	071309		071316		071323		071330		071347	
AN 2 Antracit RAL 7016	8,00	9,76	8,00	9,76	7,20	8,78	7,20	8,78	7,00	8,54
	069467		069474		069481		069498		069504	
IC 3 Črna intenzivno RAL 9005	8,00	9,76	8,00	9,76	7,20	8,78	7,20	8,78	7,00	8,54
	069900		069917		069924		069931		069948	
OC 4 Vinsko rdeča RAL 3009	8,00	9,76	8,00	9,76	7,20	8,78	7,20	8,78	7,00	8,54
	070661		070678		070685		070692		070708	
MH 5 Opečno rdeča RAL 8004	8,10	9,88			7,30	8,91	7,30	8,91	7,10	8,66
	070128				070142		070159		070166	
SB 6 Umazano bela RAL 9002	8,10	9,88	8,10	9,88	7,30	8,91	7,30	8,91	7,10	8,66
	071088		071095		071101		071118		071125	
BH 7 Srebrna RAL 9006	8,10	9,88	8,10	9,88	7,30	8,91	7,30	8,91	7,10	8,66
	069689		069696		069702		069719		069726	
PS 8 Prašno siva RAL 7037	8,10	9,88	8,10	9,88	7,30	8,91	7,30	8,91	7,10	8,66
	070883		070890		070906		070913		070920	
MM 9 Metalik bakrena RAL extra	8,50	10,37			7,75	9,46	7,75	9,46	7,55	9,21
	070340				070364		070371		070388	
BHT – P.20 10 Temno srebrna RAL 9007									8,55	10,43
									096128	
MZ 11 Zelena mahovo RAL 6005	8,50	10,37							7,55	9,21
	070586								070593	
MOT 12 Temno modra RAL 5010	8,50	10,37							7,55	9,21
	070494								070500	
TZ 13 Zelena svetlo RAL 6011	8,50	10,37					7,75	9,46		
	071521 *						071538			
Pakiranje v m 	10		15		10		10		15	
Pakiranje v m 	490		735		100		250		375	

* Izdelava po meri



CEV ODVODNA [s=0,55]
P-PZR

Nominalna velikost	80		80		80		100		100	
Dolžina v m	4,0		5,0		6,0		1,0		2,0	
Cena v €/m	Brez DDV	Z DDV	Brez DDV	Z DDV	Brez DDV	Z DDV	Brez DDV	Z DDV	Brez DDV	Z DDV
TM 1 Testa di Moro RAL 8028	7,00	8,54	7,00	8,54	7,00	8,54	7,40	9,03	7,40	9,03
	071354		071361 *		071378 *		071385		071392	
AN 2 Antracit RAL 7016	7,00	8,54	7,00	8,54	7,00	8,54	7,40	9,03	7,40	9,03
	069511		069528 *		069535 *		069542		069559	
IC 3 Črna intenzivno RAL 9005	7,00	8,54	7,00	8,54	7,00	8,54	7,40	9,03	7,40	9,03
	069955		069962 *		069979 *		069986		069993	
OC 4 Vinsko rdeča RAL 3009	7,00	8,54	7,00	8,54	7,00	8,54	7,40	9,03	7,40	9,03
	070715		070722 *		070739 *		070746		070753	
MH 5 Opečno rdeča RAL 8004	7,10	8,66	7,10	8,66	7,10	8,66	7,50	9,15	7,50	9,15
	070173		070180 *		070197 *		070203		070210	
SB 6 Umazano bela RAL 9002	7,10	8,66	7,10	8,66	7,10	8,66	7,50	9,15	7,50	9,15
	071132		071149 *		071156 *		071163		071170	
BH 7 Srebrna RAL 9006	7,10	8,66	7,10	8,66	7,10	8,66	7,50	9,15	7,50	9,15
	069733		069740 *		069757 *		069764		069771	
PS 8 Prašno siva RAL 7037	7,10	8,66	7,10	8,66	7,10	8,66	7,50	9,15	7,50	9,15
	070937		070944 *		070951 *		070968		070975	
MM 9 Metalik bakrena RAL extra	7,55	9,21					8,40	10,25	8,40	10,25
	070395						070401		070418	
BHT – P.20 10 Temno srebrna RAL 9007										
MZ 11 Zelena mahovo RAL 6005	7,55	9,21								
	070609									
MOT 12 Temno modra RAL 5010										
TZ 13 Zelena svetlo RAL 6011										
Pakiranje v m	20		5		6		10		10	
Pakiranje v m	500		625		750		70		160	

* Izdelava po meri

 POCINKANO
POLYESTER

CEV ODVODNA [s=0,55]
P-PZR

Nominalna velikost	100		100		100		100		120		
Dolžina v m	3,0		4,0		5,0		6,0		1,0		
Cena v €/m	Brez DDV	Z DDV	Brez DDV	Z DDV	Brez DDV	Z DDV	Brez DDV	Z DDV	Brez DDV	Z DDV	
TM Testa di Moro RAL 8028	1	7,20	8,78	7,20	8,78	7,20	8,78	7,20	8,78	10,75	13,12
		071408		071415		071422		071439 *		071446	
AN Antracit RAL 7016	2	7,20	8,78	7,20	8,78	7,20	8,78	7,20	8,78	10,75	13,12
		069566		069573		069580		069597 *		069603	
IC Črna intenzivno RAL 9005	3	7,20	8,78	7,20	8,78	7,20	8,78	7,20	8,78	10,75	13,12
		070005		070012		070029		070036 *		070043	
OC Vinsko rdeča RAL 3009	4	7,20	8,78	7,20	8,78	7,20	8,78	7,20	8,78	10,75	13,12
		070760		070777		070784 *		070791 *		070807	
MH Opečno rdeča RAL 8004	5	7,30	8,91	7,30	8,91	7,30	8,91	7,30	8,91	10,85	13,24
		070227		070234		070241 *		070258 *		070265	
SB Umazano bela RAL 9002	6	7,30	8,91	7,30	8,91	7,30	8,91	7,30	8,91	10,85	13,24
		071187		071194		071200 *		071217 *		071224	
BH Srebrna RAL 9006	7	7,30	8,91	7,30	8,91	7,30	8,91	7,30	8,91	10,85	13,24
		069788		069795		069801 *		069818 *		069825	
PS Prašno siva RAL 7037	8	7,30	8,91	7,30	8,91	7,30	8,91	7,30	8,91	10,85	13,24
		070982		070999		071002 *		071019 *		071026	
MM Metalik bakrena RAL extra	9	8,20	10,00	8,20	10,00					11,50	14,03
		070425		070432						070449	
BHT – P.20 Temno srebrna RAL 9007	10	8,80	10,74	8,80	10,74						
		096135		096142							
MZ Zelena mahovo RAL 6005	11	8,20	10,00	8,20	10,00						
		070616		070623							
MOT Temno modra RAL 5010	12	8,20	10,00	8,20	10,00						
		070524		070531							
TZ Zelena svetlo RAL 6011	13	8,20	10,00	8,20	10,00						
		071545		071552							
Pakiranje v m		15		20		5		6		8	
Pakiranje v m		240		320		400		480		48	

* Izdelava po meri



CEV ODVODNA [s=0,55]
P-PZR

Nominalna velikost	120		120		120		120		120	
Dolžina v m	2,0		3,0		4,0		5,0		6,0	
Cena v €/m	Brez DDV	Z DDV	Brez DDV	Z DDV	Brez DDV	Z DDV	Brez DDV	Z DDV	Brez DDV	Z DDV
TM Testa di Moro RAL 8028	10,75	13,12	10,55	12,87	10,55	12,87	10,55	12,87	10,55	12,87
	071453		071460		071477		071484 *		071491 *	
AN Antracit RAL 7016	10,75	13,12	10,55	12,87	10,55	12,87	10,55	12,87	10,55	12,87
	069610		069627		069634		069641 *		069658 *	
IC Črna intenzivno RAL 9005	10,75	13,12	10,55	12,87	10,55	12,87	10,55	12,87	10,55	12,87
	070050		070067		070074		070081 *		070098 *	
OC Vinsko rdeča RAL 3009	10,75	13,12	10,55	12,87	10,55	12,87	10,55	12,87	10,55	12,87
	070814		070821		070838		070845 *		070852 *	
MH Opečno rdeča RAL 8004	10,85	13,24	10,65	12,99	10,65	12,99	10,65	12,99	10,65	12,99
	070272		070289		070296		070302 *		070319 *	
SB Umazano bela RAL 9002	10,85	13,24	10,65	12,99	10,65	12,99	10,65	12,99	10,65	12,99
	071231		071248		071255		071262		071279 *	
BH Srebrna RAL 9006	10,85	13,24	10,65	12,99	10,65	12,99	10,65	12,99	10,65	12,99
	069832		069849		069856		069863		069870 *	
PS Prašno siva RAL 7037	10,85	13,24	10,65	12,99	10,65	12,99				
	071033		071040		071057					
MM Metalik bakrena RAL extra	11,50	14,03	11,35	13,85	11,35	13,85				
	070456		070463		070470					
BHT – P.20 Temno srebrna RAL 9007			12,05	14,70						
			096159							
MZ Zelena mahovo RAL 6005			11,35	13,85	11,35	13,85				
			070630		070647					
MOT Temno modra RAL 5010			11,35	13,85	11,35	13,85				
			070548		070555					
TZ Zelena svetlo RAL 6011			11,35	13,85	11,35	13,85				
			071569		071576					
Pakiranje v m	10		15		20		5		6	
Pakiranje v m	120		180		240		300		360	

* Izdelava po meri



CEV ODVODNA [s=0,55]
P-PZR

Nominalna velikost	150		150	
Dolžina v m	3,0		4,0	
Cena v €/m	Brez DDV	Z DDV	Brez DDV	Z DDV
TM 1 Testa di Moro RAL 8028	20,60	25,13	20,60	25,13
	071507		071514	
AN 2 Antracit RAL 7016	20,60	25,13	20,60	25,13
	069665		069672	
IC 3 Črna intenzivno RAL 9005			20,60	25,13
			070111	
OC 4 Vinsko rdeča RAL 3009			20,60	25,13
			070876	
MH 5 Opečno rdeča RAL 8004	20,70	25,25		
	070326			
SB 6 Umazano bela RAL 9002	20,70	25,25	20,70	25,25
	071286		071293	
BH 7 Srebrna RAL 9006	20,70	25,25	20,70	25,25
	069887		069894	
PS 8 Prašno siva RAL 7037	20,70	25,25	20,70	25,25
	071064		071071	
MM 9 Metalik bakrena RAL extra	21,80	26,60		
	070487			
BHT – P.20 10 Temno srebrna RAL 9007	22,25	27,15		
	096166			
MZ 11 Zelena mahovo RAL 6005	21,80	26,60		
	070654			
MOT 12 Temno modra RAL 5010			21,80	26,60
			070579	
TZ 13 Zelena svetlo RAL 6011	21,80	26,60		
	071583 *			
Pakiranje v m 	3		4	
Pakiranje v m 	84		112	

* Izdelava po meri



POCINKANO POLYESTER

CEV ODVODNA [s=0,50]

P-PZR

Nominalna velikost	80		80		80		80		80	
Dolžina v m	1,0		2,0		3,0		4,0		5,0	
Cena v €/m	Brez DDV		Brez DDV		Brez DDV		Brez DDV		Brez DDV	
TM Testa di Moro RAL 8028	5,95	7,26	5,95	7,26	5,75	7,02	5,75	7,02	5,75	7,02
	068538 *		068545 *		068552		068569 *		068576 *	
AN Antracit RAL 7016	5,25	6,41	5,25	6,41	5,10	6,22	5,10	6,22	5,10	6,22
	067869 *		067876 *		067883		067890 *		067906 *	
IC Črna intenzivno RAL 9005	5,95	7,26	5,95	7,26	5,75	7,02	5,75	7,02	5,75	7,02
	068217 *		068224 *		068231		068248 *		068255 *	
OC Vinsko rdeča RAL 3009	5,95	7,26	5,95	7,26	5,75	7,02	5,75	7,02	5,75	7,02
	068378 *		068385 *		068392		068408 *		068415 *	
BH Srebrna RAL 9006	5,95	7,26	5,95	7,26	5,75	7,02	5,75	7,02	5,75	7,02
	068033 *		068040 *		068057 *		068064 *		068071 *	
TH Tmavo hredá ČOKO RAL 8017	5,95	7,26	5,95	7,26	5,75	7,02	5,75	7,02		
	084583 *		084590 *		084606		084613 *			
MH Opečno rdeča RAL 8004	5,95	7,26	5,95	7,26	5,75	7,02	5,75	7,02	5,75	7,02
	085085 *		085092 *		085108 *		085115 *		085122 *	
Pakiranje v m	10		10		15		20		5	
Pakiranje v m	100		250		375		500		625	

* Izdelava po meri

CEV ODVODNA [s=0,50]

P-PZR

Nominalna velikost	80		100		100		100		100	
Dolžina v m	6,0		1,0		2,0		3,0		4,0	
Cena v €/m	Brez DDV		Brez DDV		Brez DDV		Brez DDV		Brez DDV	
TM Testa di Moro RAL 8028	5,75	7,02	6,50	7,93	6,50	7,93	6,30	7,69	6,30	7,69
	068583 *		068590 *		068606 *		068613		068620 *	
AN Antracit RAL 7016	5,10	6,22	5,75	7,02	5,75	7,02	5,55	6,77	5,55	6,77
	067913 *		067920 *		067937 *		067944		067951 *	
IC Črna intenzivno RAL 9005	5,75	7,02	6,50	7,93	6,50	7,93	6,30	7,69	6,30	7,69
	068262 *		068279 *		068286 *		068293		068309 *	
OC Vinsko rdeča RAL 3009	5,75	7,02	6,50	7,93	6,50	7,93	6,30	7,69	6,30	7,69
	068422 *		068439 *		068446 *		068453		068460 *	
BH Srebrna RAL 9006	5,75	7,02	6,50	7,93	6,50	7,93	6,30	7,69	6,30	7,69
	068088 *		068095 *		068101 *		068118 *		068125 *	
TH Tmavo hredá ČOKO RAL 8017			6,50	7,93	6,50	7,93	6,30	7,69	6,30	7,69
			084644 *		084651 *		084668		084675	
MH Opečno rdeča RAL 8004	5,75	7,02	6,50	7,93	6,50	7,93	6,30	7,69	6,30	7,69
	085139 *		085146 *		085153 *		085160 *		085177 *	
Pakiranje v m	6		10		10		15		20	
Pakiranje v m	750		70		160		240		320	

* Izdelava po meri



POCINKANO POLYESTER

CEV ODVODNA [s=0,50]

P-PZR



Nominalna velikost	100		100		120		120		120		
Dolžina v m	5,0		6,0		1,0		2,0		3,0		
Cena v €/m	Brez DDV		Brez DDV		Brez DDV		Brez DDV		Brez DDV		
TM Testa di Moro RAL 8028	1	6,30	7,69	6,30	7,69	9,20	11,22	9,20	11,22	9,00	10,98
		068637 *		068644 *		068651 *		068668 *		068675	
AN Antracit RAL 7016	2	5,55	6,77	5,55	6,77	8,20	10,00	8,20	10,00	8,00	9,76
		067968 *		067975 *		067982 *		085023 *		067999	
IC Črna intenzivno RAL 9005	3	6,30	7,69	6,30	7,69	9,20	11,22	9,20	11,22	9,00	10,98
		068316 *		068323 *		085078 *		084910 *		068330	
OC Vinsko rdeča RAL 3009	4	6,30	7,69	6,30	7,69	9,20	11,22	9,20	11,22	9,00	10,98
		068477 *		068484 *		084927 *		084972 *		068491 *	
BH Srebrna RAL 9006	5	6,30	7,69	6,30	7,69	9,20	11,22	9,20	11,22	9,00	10,98
		068132 *		068149 *		068156 *		068163 *		068170 *	
TH Tmavo hredá ČOKO RAL 8017	6					9,20	11,22	9,20	11,22	9,00	10,98
						084705 *		084712 *		084729 *	
MH Opečno rdeča RAL 8004	9	6,30	7,69	6,30	7,69	9,20	11,22	9,20	11,22	9,00	10,98
		085184 *		085191 *		085207 *		085214 *		085221 *	
Pakiranje v m		5		6		8		10		15	
Pakiranje v m		400		480		48		120		180	

* Izdelava po meri

CEV ODVODNA [s=0,50]

P-PZR





Nominalna velikost	120		120		120		
Dolžina v m	4,0		5,0		6,0		
Cena v €/m	Brez DDV		Brez DDV		Brez DDV		
TM Testa di Moro RAL 8028	1	9,00	10,98	9,00	10,98	9,00	10,98
		068682 *		068699 *		068705 *	
AN Antracit RAL 7016	2	8,00	9,76	8,00	9,76	8,00	9,76
		068002 *		068019 *		068026 *	
IC Črna intenzivno RAL 9005	3	9,00	10,98	9,00	10,98	9,00	10,98
		068347 *		068354 *		068361 *	
OC Vinsko rdeča RAL 3009	4	9,00	10,98	9,00	10,98	9,00	10,98
		068507 *		068514 *		068521 *	
BH Srebrna RAL 9006	5	9,00	10,98	9,00	10,98	9,00	10,98
		068187 *		068194 *		068200 *	
TH Tmavo hredá ČOKO RAL 8017	6	9,00	10,98				
		084736 *					
MH Opečno rdeča RAL 8004	9	9,00	10,98	9,00	10,98	9,00	10,98
		085238 *		085245 *		085252 *	
Pakiranje v m		20		5		6	
Pakiranje v m		240		300		360	

* Izdelava po meri

SPOJ ZA CEV

P-PSRU

Nominalna velikost	80		100		120	
	Brez DDV	Z DDV	Brez DDV	Z DDV	Brez DDV	Z DDV
TM 1 Testa di Moro RAL 8028	4,25	5,19	4,40	5,37	4,90	5,98
	017581		017598		017604	
AN 2 Antracit RAL 7016	4,25	5,19	4,40	5,37	4,90	5,98
	017284		017291		017307	
IC 3 Črna intenzivno RAL 9005	4,25	5,19	4,40	5,37	4,90	5,98
	017345		017352		017369	
OC 4 Vinsko rdeča RAL 3009	4,25	5,19	4,40	5,37	4,90	5,98
	017499		017505		017512	
MH 5 Opečno rdeča RAL 8004	4,25	5,19	4,40	5,37	4,90	5,98
	017376		017383		017390	
SB 6 Umazano bela RAL 9002	4,25	5,19	4,40	5,37	4,90	5,98
	017550		017567		017574	
BH 7 Srebrna RAL 9006	4,25	5,19	4,40	5,37	4,90	5,98
	017314		017321		017338	
PS 8 Prašno siva RAL 7037	4,25	5,19	4,40	5,37	4,90	5,98
	017529		017536		017543	
MM 9 Metalik bakrena RAL extra	4,25	5,19	4,40	5,37	4,90	5,98
	017406		017413		017420	
BHT – P.20 10 Temno srebrna RAL 9007	4,25	5,19	4,40	5,37	4,90	5,98
	095657 *		095664		095671 *	
MZ 11 Zelena mahovo RAL 6005	4,25	5,19	4,40	5,37	4,90	5,98
	017468 *		017475		017482	
MOT 12 Temno modra RAL 5010	4,25	5,19	4,40	5,37	4,90	5,98
	017437 *		017444		017451	
TZ 13 Zelena svetlo RAL 6011	4,25	5,19	4,40	5,37	4,90	5,98
	017611 *		017628		017635 *	
Pakiranje v kos 	10		10		8	
Pakiranje v kos 	900		900		720	

* Izdelava po meri



ODTOČNO KOLENO ODSKOKOVÉ

P-PKO



Nominalna velikost	80		100		120	
	Brez DDV	Z DDV	Brez DDV	Z DDV	Brez DDV	Z DDV
TM 1 Testa di Moro RAL 8028	9,40	11,47	9,70	11,83	13,95	17,02
	034045		034052		034069	
AN 2 Antracit RAL 7016	9,40	11,47	9,70	11,83	13,95	17,02
	033741		033758		033765	
IC 3 Črna intenzivno RAL 9005	9,40	11,47	9,70	11,83	13,95	17,02
	033802		033819		033826	
OC 4 Vinsko rdeča RAL 3009	9,40	11,47	9,70	11,83	13,95	17,02
	033956		033963		033970	
MH 5 Opečno rdeča RAL 8004	9,40	11,47	9,70	11,83	13,95	17,02
	033833		033840		033857	
SB 6 Umazano bela RAL 9002	9,40	11,47	9,70	11,83	13,95	17,02
	034014		034021		034038	
BH 7 Srebrna RAL 9006	9,40	11,47	9,70	11,83	13,95	17,02
	033772		033789		033796	
PS 8 Prašno siva RAL 7037	9,40	11,47	9,70	11,83	13,95	17,02
	033987		033994		034007	
MM 9 Metalik bakrena RAL extra	9,40	11,47	9,70	11,83	13,95	17,02
	033864		033871		033888	
BHT – P.20 10 Temno srebrna RAL 9007	9,40	11,47	9,70	11,83	13,95	17,02
	095688		095695		095701	
MZ 11 Zelena mahovo RAL 6005	9,40	11,47	9,70	11,83	13,95	17,02
	033925		033932		033949	
MOT 12 Temno modra RAL 5010	9,40	11,47	9,70	11,83	13,95	17,02
	033895		033901		033918	
TZ 13 Zelena svetlo RAL 6011	9,40	11,47	9,70	11,83	13,95	17,02
	034076		034083		034090	
Pakiranje v kos	20		20		15	
Pakiranje v kos	320		240		180	

REDUKCIJA CEVI 72°

P-PZO

Nominalna velikost	80/80		100/60		100/80		100/100	
	Brez DDV	Z DDV	Brez DDV	Z DDV	Brez DDV	Z DDV	Brez DDV	Z DDV
TM 1 Testa di Moro RAL 8028	15,65	19,09	17,40	21,23	17,40	21,23	18,00	21,96
	016157		016164		016171		016188	
AN 2 Antracit RAL 7016	15,65	19,09	17,40	21,23	17,40	21,23	18,00	21,96
	015259		015266		015273		015280	
IC 3 Črna intenzivno RAL 9005	15,65	19,09	17,40	21,23	17,40	21,23	18,00	21,96
	015433		015440		015457		015464	
OC 4 Vinsko rdeča RAL 3009	15,65	19,09	17,40	21,23	17,40	21,23	18,00	21,96
	015884		015891		015907		015914	
MH 5 Opečno rdeča RAL 8004	15,65	19,09	17,40	21,23	17,40	21,23	18,00	21,96
	015525		015532 *		015549		015556	
SB 6 Umazano bela RAL 9002	15,65	19,09	17,40	21,23	17,40	21,23	18,00	21,96
	016065		016072 *		016089		016096	
BH 7 Srebrna RAL 9006	15,65	19,09	17,40	21,23	17,40	21,23	18,00	21,96
	015341		015358 *		015365		015372	
PS 8 Prašno siva RAL 7037	15,65	19,09	17,40	21,23	17,40	21,23	18,00	21,96
	015976 *		015983 *		015990		016003	
MM 9 Metalik bakrena RAL extra	15,65	19,09	17,40	21,23	17,40	21,23	18,00	21,96
	015617		015624 *		015631		015648	
BHT – P.20 10 Temno srebrna RAL 9007	15,65	19,09			17,40	21,23	18,00	21,96
	096005 *				096012 *		096029 *	
MZ 11 Zelena mahovo RAL 6005	15,65	19,09	17,40	21,23	17,40	21,23	18,00	21,96
	015792		015808 *		015815		015822	
MOT 12 Temno modra RAL 5010	15,65	19,09	17,40	21,23	17,40	21,23	18,00	21,96
	015709 *		015716 *		015723 *		015730	
TZ 13 Zelena svetlo RAL 6011	15,65	19,09	17,40	21,23	17,40	21,23	18,00	21,96
	016249 *		016256 *		016263 *		016270 *	
Pakiranje v kos 	4		4		4		4	
Pakiranje v kos 	120		120		120		120	

* Izdelava po meri



REDUKCIJA CEVI 72°

P-PZO



Nominalna velikost	120/80		120/100		120/120		150/120		150/150	
	Brez DDV	Z DDV	Brez DDV	Z DDV	Brez DDV	Z DDV	Brez DDV	Z DDV	Brez DDV	Z DDV
TM 1 Testa di Moro RAL 8028	19,80	24,16	19,80	24,16	19,80	24,16	28,80	35,14	28,80	35,14
	016195		016201		016218		016225 *		016232 *	
AN 2 Antracit RAL 7016	19,80	24,16	19,80	24,16	19,80	24,16	28,80	35,14	28,80	35,14
	015297		015303		015310		015327 *		015334 *	
IC 3 Črna intenzivno RAL 9005	19,80	24,16	19,80	24,16	19,80	24,16	28,80	35,14	28,80	35,14
	015471		015488		015495		015501 *		015518 *	
OC 4 Vinsko rdeča RAL 3009	19,80	24,16	19,80	24,16	19,80	24,16	28,80	35,14	28,80	35,14
	015921		015938		015945		015952 *		015969 *	
MH 5 Opečno rdeča RAL 8004	19,80	24,16	19,80	24,16	19,80	24,16	28,80	35,14	28,80	35,14
	015563		015570		015587		015594 *		015600 *	
SB 6 Umazano bela RAL 9002	19,80	24,16	19,80	24,16	19,80	24,16	28,80	35,14	28,80	35,14
	016102		016119		016126		016133 *		016140 *	
BH 7 Srebrna RAL 9006	19,80	24,16	19,80	24,16	19,80	24,16	28,80	35,14	28,80	35,14
	015389		015396		015402		015419 *		015426 *	
PS 8 Prašno siva RAL 7037	19,80	24,16	19,80	24,16	19,80	24,16	28,80	35,14	28,80	35,14
	016010 *		016027		016034		016041 *		016058 *	
MM 9 Metalik bakrena RAL extra	19,80	24,16	19,80	24,16	19,80	24,16	28,80	35,14	28,80	35,14
	015655 *		015662		015679		015686 *		015693 *	
BHT – P.20 10 Temno srebrna RAL 9007	19,80	24,16	19,80	24,16	19,80	24,16				
	096036 *		096043 *		096050 *					
MZ 11 Zelena mahovo RAL 6005	19,80	24,16	19,80	24,16	19,80	24,16	28,80	35,14	28,80	35,14
	015839 *		015846 *		015853 *		015860 *		015877 *	
MOT 12 Temno modra RAL 5010	19,80	24,16	19,80	24,16	19,80	24,16	28,80	35,14	28,80	35,14
	015747 *		015754 *		015761 *		015778 *		015785 *	
TZ 13 Zelena svetlo RAL 6011	19,80	24,16	19,80	24,16	19,80	24,16	28,80	35,14	28,80	35,14
	016287 *		016294 *		016300 *		016317 *		016324 *	
Pakiranje v kos	3		3		3		2		2	
Pakiranje v kos	90		90		90		36		36	

* Izdelava po meri

ODTOČNI RAZDELILNIK VODE

P-PRV

Nominalna velikost	80		100		120	
	Brez DDV	Z DDV	Brez DDV	Z DDV	Brez DDV	Z DDV
TM 1 Testa di Moro RAL 8028	195,00	237,90	199,90	243,88	259,00	315,98
	088413 *		088420		088437 *	
AN 2 Antracit RAL 7016	195,00	237,90	199,90	243,88	259,00	315,98
	088116 *		088123		088130 *	
IC 3 Črna intenzivno RAL 9005	195,00	237,90	199,90	243,88	259,00	315,98
	088178 *		088185 *		088192 *	
OC 4 Vinsko rdeča RAL 3009	195,00	237,90	199,90	243,88	259,00	315,98
	088321 *		088338 *		088345 *	
MH 5 Opečno rdeča RAL 8004	195,00	237,90	199,90	243,88	259,00	315,98
	088208 *		088215 *		088222 *	
SB 6 Umazano bela RAL 9002	195,00	237,90	199,90	243,88	259,00	315,98
	088383 *		088390 *		088406 *	
BH 7 Srebrna RAL 9006	195,00	237,90	199,90	243,88	259,00	315,98
	088147 *		088154 *		088161 *	
PS 8 Prašno siva RAL 7037	195,00	237,90	199,90	243,88	259,00	315,98
	088352 *		088369 *		088376 *	
MM 9 Metalik bakrena RAL extra	195,00	237,90	199,90	243,88	259,00	315,98
	088239 *		088246 *		088253 *	
BHT – P.20 10 Temno srebrna RAL 9007	195,00	237,90	199,90	243,88	259,00	315,98
	095756 *		095763 *		095770 *	
MZ 11 Zelena mahovo RAL 6005	195,00	237,90	199,90	243,88	259,00	315,98
	088291 *		088307 *		088314 *	
MOT 12 Temno modra RAL 5010	195,00	237,90	199,90	243,88	259,00	315,98
	088260 *		088277 *		088284 *	
TZ 13 Zelena svetlo RAL 6011	195,00	237,90	199,90	243,88	259,00	315,98
	088444 *		088451 *		088468 *	
Pakiranje v kos 	1		1		1	
Pakiranje v kos 	-		-		-	

* Izdelava po meri



OBJEMKA Z ŽEBLJEM 150 mm

P-PO

Nominalna velikost	80		100		120	
	Brez DDV	Z DDV	Brez DDV	Z DDV	Brez DDV	Z DDV
TM 1 Testa di Moro RAL 8028	3,30	4,03	3,35	4,09	4,00	4,88
	002136		002143		002150	
AN 2 Antracit RAL 7016	3,30	4,03	3,35	4,09	4,00	4,88
	001986		001993		002006	
IC 3 Črna intenzivno RAL 9005	3,30	4,03	3,35	4,09	4,00	4,88
	002013		002020		002037	
OC 4 Vinsko rdeča RAL 3009	3,30	4,03	3,35	4,09	4,00	4,88
	002075		002082		002099	
MH 5 Opečno rdeča RAL 8004	3,30	4,03	3,35	4,09	4,00	4,88
	002044		002051		002068	
SB 6 Umazano bela RAL 9002	3,30	4,03	3,35	4,09	4,00	4,88
	002105		002112		002129	
Pakiranje v kos 📦	25		25		25	
Pakiranje v kos 🚚	1 000		1 000		1 000	



OBJEMKA Z ŽEBLJEM 200 mm



P-POD

Nominalna velikost	80		100		120	
	Brez DDV	Z DDV	Brez DDV	Z DDV	Brez DDV	Z DDV
TM 1 Testa di Moro RAL 8028	3,50	4,27	3,50	4,27	4,05	4,94
	001955		001962		001979	
AN 2 Antracit RAL 7016	3,50	4,27	3,50	4,27	4,05	4,94
	001801		001818		001825	
IC 3 Črna intenzivno RAL 9005	3,50	4,27	3,50	4,27	4,05	4,94
	001832		001849		001856	
OC 4 Vinsko rdeča RAL 3009	3,50	4,27	3,50	4,27	4,05	4,94
	001894		001900		001917	
MH 5 Opečno rdeča RAL 8004	3,50	4,27	3,50	4,27	4,05	4,94
	001863		001870		001887	
SB 6 Umazano bela RAL 9002	3,50	4,27	3,50	4,27	4,05	4,94
	001924		001931		001948	
Pakiranje v kos 📦	25		25		25	
Pakiranje v kos 🚚	1 000		1 000		1 000	



OBJEMKA Z ŽEBLJEM 300 mm

P-PODD

Nominalna velikost	100		120	
	Brez DDV	Z DDV	Brez DDV	Z DDV
TM 1 Testa di Moro RAL 8028	4,55	5,55	4,95	6,04
	002402		002419	
AN 2 Antracit RAL 7016	4,55	5,55	4,95	6,04
	002303		002310	
IC 3 Črna intenzivno RAL 9005	4,55	5,55	4,95	6,04
	002327		002334	
OC 4 Vinsko rdeča RAL 3009	4,55	5,55	4,95	6,04
	002365		002372	
MH 5 Opečno rdeča RAL 8004	4,55	5,55	4,95	6,04
	002341		002358	
SB 6 Umazano bela RAL 9002	4,55	5,55	4,95	6,04
	002389		002396	
Pakiranje v kos 	20		20	
Pakiranje v kos 	800		800	



POCINKANO
POLYESTER



OBJEMKA Z NAVOJEM M10

P-POB

Nominalna velikost	60		80		100		120		150	
	Brez DDV	Z DDV	Brez DDV	Z DDV	Brez DDV	Z DDV	Brez DDV	Z DDV	Brez DDV	Z DDV
TM 1 Testa di Moro RAL 8028	2,90	3,54	2,65	3,23	2,75	3,36	3,30	4,03	4,90	5,98
	074119		074126		074133		074140		074157	
AN 2 Antracit RAL 7016	2,90	3,54	2,65	3,23	2,75	3,36	3,30	4,03	4,90	5,98
	073471		073488		073495		073501		073518	
IC 3 Črna intenzivno RAL 9005	2,90	3,54	2,65	3,23	2,75	3,36	3,30	4,03	4,90	5,98
	073679		073686		073693		073709		073716	
OC 4 Vinsko rdeča RAL 3009	2,90	3,54	2,65	3,23	2,75	3,36	3,30	4,03	4,90	5,98
	073914		073921		073938		073945		073952	
MH 5 Opečno rdeča RAL 8004	2,90	3,54	2,65	3,23	2,75	3,36	3,30	4,03	4,90	5,98
	073723		073730		073747		073754		073761	
SB 6 Umazano bela RAL 9002	2,90	3,54	2,65	3,23	2,75	3,36	3,30	4,03	4,90	5,98
	074010		074027		074034		074041		074058	
BH 7 Srebrna RAL 9006	2,90	3,54	2,65	3,23	2,75	3,36	3,30	4,03	4,90	5,98
	073570		073587		073594		073600		073617	
PS 8 Prašno siva RAL 7037	2,90	3,54	2,65	3,23	2,75	3,36	3,30	4,03	4,90	5,98
	073969		073976		073983		073990		074003	
MM 9 Metalik bakrena RAL extra	2,90	3,54	2,65	3,23	2,75	3,36	3,30	4,03	4,90	5,98
	073778		073785		073792		073808		077158	
BHT – P.20 10 Temno srebrna RAL 9007	2,90	3,54	2,65	3,23	2,75	3,36	3,30	4,03	4,90	5,98
	119711		094537		094544		094551		094674	
MZ 11 Zelena mahovo RAL 6005	2,90	3,54	2,65	3,23	2,75	3,36	3,30	4,03	4,90	5,98
	073860		073877		073884		073891		073907	
MOT 12 Temno modra RAL 5010	2,90	3,54	2,65	3,23	2,75	3,36	3,30	4,03	4,90	5,98
	073815		073822		073839		073846		073853	
TZ 13 Zelena svetlo RAL 6011	2,90	3,54	2,65	3,23	2,75	3,36	3,30	4,03	4,90	5,98
	074164 *		074171		074188		074195		074201 *	
Pakiranje v kos	25		25		25		25		20	
Pakiranje v kos	3 000		3 000		3 000		3 000		2 400	

* Izdelava po meri



OBJEMKA Z NAVOJEM M8

P-POB





Nominalna velikost	60		80		100		120		150	
	Brez DDV	Z DDV	Brez DDV	Z DDV	Brez DDV	Z DDV	Brez DDV	Z DDV	Brez DDV	Z DDV
TM 1 Testa di Moro RAL 8028	2,90	3,54	2,65	3,23	2,75	3,36	3,30	4,03	4,90	5,98
	074065		074072		074089		074096		074102	
AN 2 Antracit RAL 7016	2,90	3,54	2,65	3,23	2,75	3,36	3,30	4,03	4,90	5,98
	073426		073433		073440		073457		073464	
IC 3 Črna intenzivno RAL 9005	2,90	3,54	2,65	3,23	2,75	3,36	3,30	4,03	4,90	5,98
	073624		073631		073648		073655		073662	
BH 7 Srebrna RAL 9006	2,90	3,54	2,65	3,23	2,75	3,36	3,30	4,03	4,90	5,98
	073532		073525		073549		073556		073563	
Pakiranje v kos	25		25		25		25		20	
Pakiranje v kos	3 000		3 000		3 000		3 000		2 400	



INOX VIJAK ZA OBJEMKO M6x20

P-POB-NSK





Nominalna velikost	EAN številko izdelka	Pakiranje v kos		Cena [€/kos]	
				Brez DDV	Z DDV
M6 x 20 *	071675	1	–	0,15	0,18

* Izdelava po meri

VIJAK ZA OBJEMKO TORX M10

P-POB-HT





Nominalna velikost	EAN številko izdelka	Pakiranje v kos		Cena [€/kos]	
				Brez DDV	Z DDV
80	002464	100	40 000	1,00	1,22
140	002471	100	28 000	1,25	1,53
200	002488	100	20 000	1,55	1,89
250	002495	100	16 000	1,70	2,07
300	002501	100	11 200	1,70	2,07

POCINKANO
POLYESTER

VLOŽEK M10

P-POB-HN DB





Nominalna velikost	EAN številko izdelka	Pakiranje v kos		Cena [€/kos]	
				Brez DDV	Z DDV
120	002426	100	25 000	0,40	0,49

VLOŽEK Z LAMELO M10

P-POB-HN DB





Nominalna velikost	EAN številko izdelka	Pakiranje v kos		Cena [€/kos]	
				Brez DDV	Z DDV
180	002433	100	12 000	0,42	0,51
240	002440	100	12 000	0,50	0,61
280	002457	100	12 000	0,53	0,65

KOMBINIRANI VIJAK TORX M10

P-POB-ZT/SZ



Nominalna velikost	EAN številko izdelka	Pakiranje v kos		Cena [€/kos]	
				Brez DDV	Z DDV
140	002587	50	10 400	0,45	0,55
180	002594	50	10 400	0,55	0,67

POCINKANO POLYESTER

VLOŽEK ZA OBJEMKU 7x7

P-POB-HN R1



Nominalna velikost	EAN številko izdelka	Pakiranje v kos		Cena [€/kos]	
				Brez DDV	Z DDV
200/60	002600	250	15 000	0,17	0,21

VLOŽEK ZA IZOLACIJO M10

P-POB-HN IZOL



Nominalna velikost	EAN številko izdelka	Pakiranje v kos		Cena [€/kos]	
				Brez DDV	Z DDV
M10 x 96	001207	25	2 625	2,70	3,29

IZOLACIJSKI ZATIČ KONICA ZIDAK BREZ TOPLLOTNE IZOLACIJE

P-POB-HN WDVS140 M10



Nominalna velikost	EAN številko izdelka	Pakiranje v kos		Cena [€/kos]	
				Brez DDV	Z DDV
140	144843	1/5	750	4,80	5,86

IZOLACIJSKI ZATIČ KONICA ZIDAK S TOPLLOTNO IZOLACIJO

P-POB-HN WDVS300 M10



Nominalna velikost	EAN številko izdelka	Pakiranje v kos		Cena [€/kos]	
				Brez DDV	Z DDV
300	144850	1/5	500	7,80	9,52

NERJAVNA UNI PLATFORMA ZA PRITRJEVANJE OB M10

P-POB-HN PLAT M10



Nominalna velikost	EAN številko izdelka	Pakiranje v kos		Cena [€/kos]	
				Brez DDV	Z DDV
M10	144836	25/500	5 000	3,35	4,09

NAVOJNA PALICA M10

P-POB-ZT



Nominalna velikost	EAN številko izdelka	Pakiranje v kos		Cena [€/kos]	
				Brez DDV	Z DDV
60	002556	100	20 800	0,20	0,24
100	002563	100	15 600	0,30	0,37
150	002570	50	10 400	0,55	0,67

PRITRDILNA PLOŠČA M10

P-POB-ZT MP



Nominalna velikost	EAN številko izdelka	Pakiranje v kos		Cena [€/kos]	
				Brez DDV	Z DDV
80 x 30	002518	25	5 200	1,15	1,40

VIJAK ZA OBJEMKO M8

P-POB-HB



Nominalna velikost	EAN številko izdelka	Pakiranje v kos		Cena [€/kos]	
				Brez DDV	Z DDV
150	071590	100	5 000	0,65	0,79
200	071606	100	5 000	0,92	1,12
250	071613	100	5 000	1,05	1,28
300	071620	100	5 000	1,10	1,34

VLOŽEK M8

P-POB-HBN-SS



Nominalna velikost	EAN številko izdelka	Pakiranje v kos		Cena [€/kos]	
				Brez DDV	Z DDV
150	071637	100	5 000	0,25	0,31
200	071644	100	5 000	0,26	0,32
250	071651	100	5 000	0,35	0,43
300	071668	100	8 000	0,37	0,45

ZAŠČITNI POKROV OBJEMKE

P-POB-HT AKG



Nominalna velikost	EAN številko izdelka	Pakiranje v kos		Cena [€/kos]	
				Brez DDV	Z DDV
29 x 13	002280	50	16 800	0,25	0,31
29 x 13	002211	50	16 800	0,25	0,31
29 x 13	002235	50	16 800	0,25	0,31
29 x 13	002266	50	16 800	0,25	0,31
29 x 13	002242	50	16 800	0,25	0,31
29 x 13	002228	50	16 800	0,25	0,31
29 x 13	002273	50	16 800	0,25	0,31
29 x 13	002259	50	16 800	0,25	0,31
29 x 13	002297	50	16 800	0,25	0,31

LOVILEC VODE

P-PZV



Nominalna velikost	80		100		120	
	Brez DDV	Z DDV	Brez DDV	Z DDV	Brez DDV	Z DDV
TM 1 Testa di Moro RAL 8028	12,55	15,31	12,95	15,80	19,00	23,18
	034533		034540		034557	
AN 2 Antracit RAL 7016	12,55	15,31	12,95	15,80	19,00	23,18
	034410		034427		034434	
IC 3 Črna intenzivno RAL 9005	12,55	15,31	12,95	15,80	19,00	23,18
	034441		034458		034465	
OC 4 Vinsko rdeča RAL 3009	12,55	15,31	12,95	15,80	19,00	23,18
	034502		034519		034526	
MH 5 Opečno rdeča RAL 8004	12,55	15,31	12,95	15,80	19,00	23,18
	034472		034489		034496	
Pakiranje v kos	6		5		3	
Pakiranje v kos	180		150		90	

LOVILEC VODE S SITOM

P-PZVS



Nominalna velikost	80		100		120	
	Brez DDV	Z DDV	Brez DDV	Z DDV	Brez DDV	Z DDV
TM 1 Testa di Moro RAL 8028	12,55	15,31	12,95	15,80	19,00	23,18
	034861		034878		034885	
AN 2 Antracit RAL 7016	12,55	15,31	12,95	15,80	19,00	23,18
	034564		034571		034588	
IC 3 Črna intenzivno RAL 9005	12,55	15,31	12,95	15,80	19,00	23,18
	034625		034632		034649	
OC 4 Vinsko rdeča RAL 3009	12,55	15,31	12,95	15,80	19,00	23,18
	034779		034786		034793	
MH 5 Opečno rdeča RAL 8004	12,55	15,31	12,95	15,80	19,00	23,18
	034656		034663		034670	
SB 6 Umazano bela RAL 9002	12,55	15,31	12,95	15,80	19,00	23,18
	034830		034847		034854	
BH 7 Srebrna RAL 9006	12,55	15,31	12,95	15,80	19,00	23,18
	034595		034601		034618	
PS 8 Prašno siva RAL 7037	12,55	15,31	12,95	15,80	19,00	23,18
	034809		034816		034823	
MM 9 Metalik bakrena RAL extra	12,55	15,31	12,95	15,80	19,00	23,18
	034687		034694		034700	
BHT – P.20 10 Temno srebrna RAL 9007	12,55	15,31	12,95	15,80	19,00	23,18
	095718		095725		095732	
MZ 11 Zelena mahovo RAL 6005	12,55	15,31	12,95	15,80	19,00	23,18
	034748		034755		034762	
MOT 12 Temno modra RAL 5010	12,55	15,31	12,95	15,80	19,00	23,18
	034717		034724		034731	
TZ 13 Zelena svetlo RAL 6011	12,55	15,31	12,95	15,80	19,00	23,18
	034892 *		034908		034915	
Pakiranje v kos	6		5		3	
Pakiranje v kos	180		150		90	

* Izdelava po meri

ALUMINIJ LOVILEC VODE S CEVJO

P-PZVHA



Nominalna velikost	80		120	
	Brez DDV	Z DDV	Brez DDV	Z DDV
TM 1 Testa di Moro RAL 8028	65,00	79,30	125,00	152,50
	018793		018816	
AN 2 Antracit RAL 7016	65,00	79,30	125,00	152,50
	018496		018519	
IC 3 Črna intenzivno RAL 9005	65,00	79,30	125,00	152,50
	018557		018571	
OC 4 Vinsko rdeča RAL 3009	65,00	79,30	125,00	152,50
	018700		018724 *	
MH 5 Opečno rdeča RAL 8004	65,00	79,30	125,00	152,50
	018588 *		018601 *	
SB 6 Umazano bela RAL 9002	65,00	79,30	125,00	152,50
	018762 *		018786	
BH 7 Srebrna RAL 9006	65,00	79,30	125,00	152,50
	018526		018540	
PS 8 Prašno siva RAL 7037	65,00	79,30	125,00	152,50
	018731 *		018755 *	
MM 9 Metalik bakrena RAL extra	65,00	79,30	125,00	152,50
	018618 *		018632 *	
BHT – P.20 10 Temno srebrna RAL 9007	65,00	79,30	125,00	152,50
	095527 *		095541 *	
MZ 11 Zelena mahovo RAL 6005	65,00	79,30	125,00	152,50
	018670 *		018694 *	
MOT 12 Temno modra RAL 5010	65,00	79,30	125,00	152,50
	018649 *		018663 *	
TZ 13 Zelena svetlo RAL 6011	65,00	79,30	125,00	152,50
	018823 *		018847 *	
Pakiranje v kos 		1		1
Pakiranje v kos 		60		60

* Izdelava po meri



ALUMINIJ LOVILEC VODE S CEVJO IN GUMBOM

P-PZVHAG

Nominalna velikost	100	
Cena v €/kos	Brez DDV	Z DDV
TM 1 Testa di Moro RAL 8028	60,00	73,20
		018809
AN 2 Antracit RAL 7016	60,00	73,20
		018502
IC 3 Črna intenzivno RAL 9005	–	–
		–
OC 4 Vinsko rdeča RAL 3009	60,00	73,20
		018717
MH 5 Opečno rdeča RAL 8004	60,00	73,20
		018595
SB 6 Umazano bela RAL 9002	60,00	73,20
		018779
BH 7 Srebrna RAL 9006	–	–
		–
PS 8 Prašno siva RAL 7037	60,00	73,20
		018748
MM 9 Metalik bakrena RAL extra	60,00	73,20
		018625 *
BHT – P.20 10 Temno srebrna RAL 9007	60,00	73,20
		095534 *
MZ 11 Zelena mahovo RAL 6005	–	–
		–
MOT 12 Temno modra RAL 5010	60,00	73,20
		018656 *
TZ 13 Zelena svetlo RAL 6011	60,00	73,20
		018830 *
Pakiranje v kos 		1
Pakiranje v kos 		60



* Izdelava po meri

ZAŠČITNA CEV Z REVIZIJSKO ODPRTINO

P-POZR

Nominalna velikost	80		100		100		
	1,0		1,0		1,5		
Dolžina v m	1,0		1,0		1,5		
Cena v €/m	Brez DDV	Z DDV	Brez DDV	Z DDV	Brez DDV	Z DDV	
TM Testa di Moro RAL 8028	1	64,00	78,08	49,00	59,78	97,00	118,34
		010254 *		010261		010278	
AN Antracit RAL 7016	2	64,00	78,08	49,00	59,78	97,00	118,34
		009760 *		009777		009784 *	
IC Črna intenzivno RAL 9005	3	64,00	78,08	49,00	59,78	97,00	118,34
		009869 *		009876		009883 *	
OC Vinsko rdeča RAL 3009	4	64,00	78,08	49,00	59,78	97,00	118,34
		010117 *		010124 *		010131 *	
MH Opečno rdeča RAL 8004	5	64,00	78,08	49,00	59,78	97,00	118,34
		009913 *		009920 *		009937 *	
SB Umazano bela RAL 9002	6	64,00	78,08	49,00	59,78	97,00	118,34
		010209 *		010247 *		010216 *	
BH Srebrna RAL 9006	7	64,00	78,08	49,00	59,78	97,00	118,34
		009814 *		009821 *		009838 *	
PS Prašno siva RAL 7037	8	64,00	78,08	49,00	59,78	97,00	118,34
		010162 *		010179 *		010186 *	
MM Metalik bakrena RAL extra	9	64,00	78,08	49,00	59,78	97,00	118,34
		009968 *		009975 *		009982 *	
BHT – P.20 Temno srebrna RAL 9007	10	64,00	78,08	49,00	59,78		
		096494 *		096500 *			
MZ Zelena mahovo RAL 6005	11	64,00	78,08	49,00	59,78	97,00	118,34
		010063 *		010070 *		010087 *	
MOT Temno modra RAL 5010	12	64,00	78,08	49,00	59,78	97,00	118,34
		010018 *		010025 *		010032 *	
TZ Zelena svetlo RAL 6011	13	64,00	78,08	49,00	59,78	97,00	118,34
		010308 *		010315 *		010322 *	
Pakiranje v kos		1		1		1	
Pakiranje v kos		70		60		60	

* Izdelava po meri



POCINKANO
POLYESTER

POCINKANO POLYESTER

ZAŠČITNA CEV Z REVIZIJSKO ODPRTINO

P-POZR



Nominalna velikost	120		120	
	1,0		1,5	
Dolžina v m				
Cena v €/m	Brez DDV	Z DDV	Brez DDV	Z DDV
TM 1 Testa di Moro RAL 8028	115,00	140,30	165,00	201,30
	010285		010292 *	
AN 2 Antracit RAL 7016	115,00	140,30	165,00	201,30
	009791 *		009807 *	
IC 3 Črna intenzivno RAL 9005	115,00	140,30	165,00	201,30
	009890 *		009906 *	
OC 4 Vinsko rdeča RAL 3009	115,00	140,30	165,00	201,30
	010148 *		010155 *	
MH 5 Opečno rdeča RAL 8004	115,00	140,30	165,00	201,30
	009944 *		009951 *	
SB 6 Umazano bela RAL 9002	115,00	140,30	165,00	201,30
	010223 *		010230 *	
BH 7 Srebrna RAL 9006	115,00	140,30	165,00	201,30
	009845 *		009852 *	
PS 8 Prašno siva RAL 7037	115,00	140,30	165,00	201,30
	010193 *		009753 *	
MM 9 Metalik bakrena RAL extra	115,00	140,30	165,00	201,30
	009999 *		010001 *	
BHT – P.20 10 Temno srebrna RAL 9007	115,00	140,30		
	096517 *			
MZ 11 Zelena mahovo RAL 6005	115,00	140,30	165,00	201,30
	010094 *		010100 *	
MOT 12 Temno modra RAL 5010	115,00	140,30	165,00	201,30
	010049 *		010056 *	
TZ 13 Zelena svetlo RAL 6011	103,00	125,66	150,00	183,00
	010339 *		010346 *	
Pakiranje v kos	1		1	
Pakiranje v kos	40		40	

* Izdelava po meri

OBJEMKA Z GUMO M10

P-POB-OZR



Nominalna velikost	EAN številko izdelka	Pakiranje v kos		Cena [€/kos]	
				Brez DDV	Z DDV
80	002525	25	1 250	1,55	1,89
100	002532	25	1 250	2,00	2,44
120	002549	20	1 000	2,25	2,75

POCINKANO POLYESTER

POCINKANO
POLYESTER

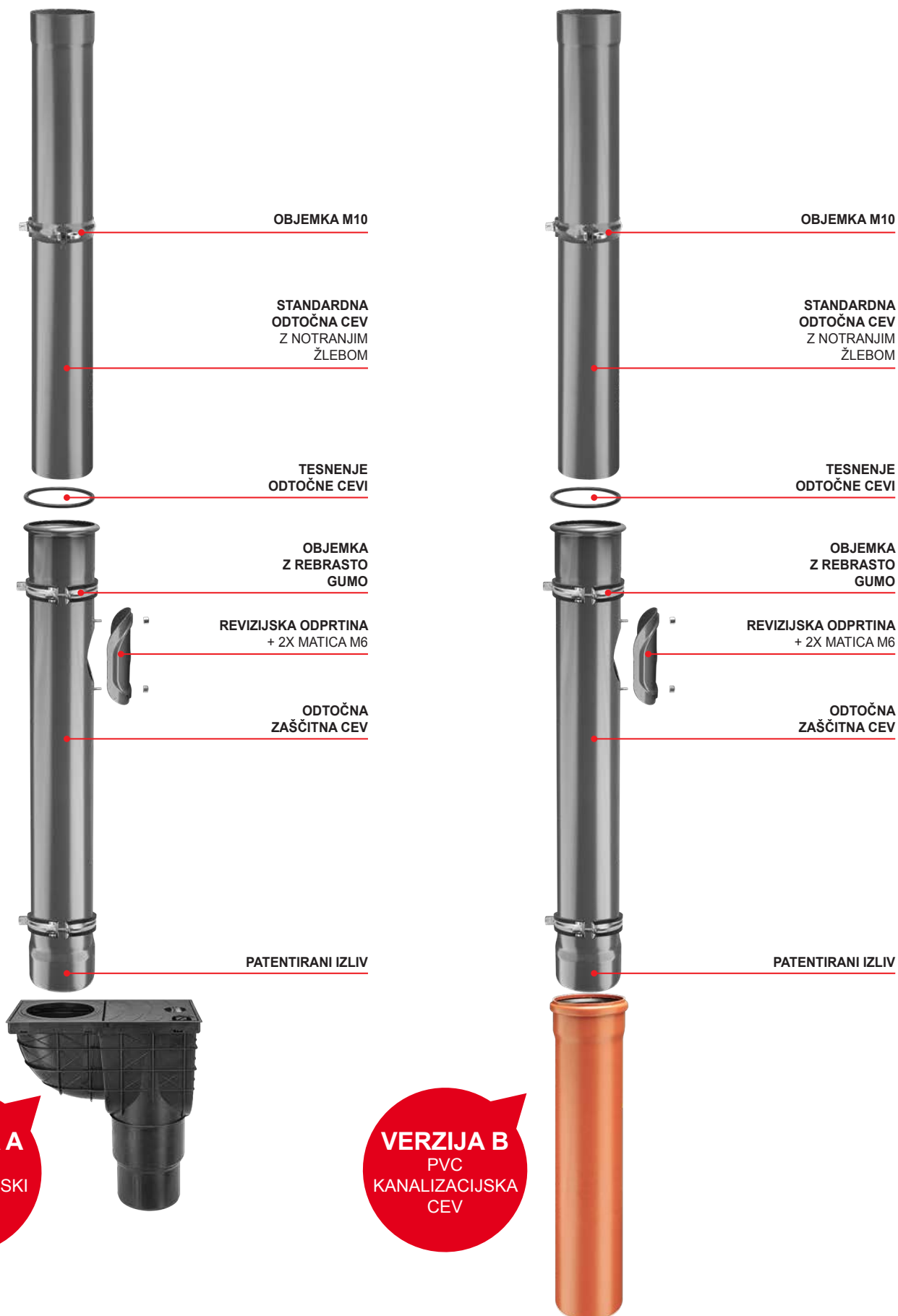

VERZIJA A
PVC
KANALIZACIJSKI
ODTOK

VERZIJA B
PVC
KANALIZACIJSKA
CEV

I. OSNOVNA DOLOČILA

- Družba KJG a.s., s sedežem Malinovského 800/131, 916 21 Čachtice, MŠ: 31 439 951 (v nadaljevanju „prodajalec“), izdaja naslednje splošne poslovne pogoje za prodajo in dobavo žlebnega strešnega sistema in opreme, lahke strešne kritine, trapezov, metalurškega materiala, strešnih dodatkov, orodij, strojev in drugega blaga v povezavi s strešnim sistemom (v nadaljevanju „blago“), ki jo prodajalec izvaja na podlagi okvirne kupne pogodbe (v nadaljevanju „OKP“) v odnosu do podjetnika pri izvajanju njegove poslovne dejavnosti in do države, državne ustanove, upravne enote ali javne institucije za zagotavljanje javnih potreb ali lastnega obratovanja (v nadaljevanju „kupec“).
- Splošni poslovni pogoji so kot del OKP sestavni del vsake posamezne kupoprodajne pogodbe (v nadaljevanju tudi „pogodba“), ki jo sklene prodajalec in kupec na podlagi OKP.

II. SKLENITEV KUPNE POGODBE

- Pisno naročilo kupca pomeni predlog za sklenitev posamezne kupoprodajne pogodbe, pri čemer mora vsako naročilo kupca vsebovati:
 - identifikacijske podatke kupca, ki so potrebni za izdajo računa;
 - opredelitev naročenega blaga (zlasti tip, vrsto, količino in mere);
 - kraj dobave, dobavni rok in način dobave blaga;
 - datum naročila;
 - ime, priimek, funkcija in podpis osebe, ki lahko zastopa kupca.
- Posamezna kupoprodajna pogodba je sklenjena v trenutku, ko prodajalec pisno potrdi naročilo kupca.

III. KUPNINA IN PLAČILNI POGOJI

- Kupec se zavezuje, da bo prodajalcu redno in pravočasno plačal kupnino za naročeno blago. Kupnina je določena po ceniku prodajalca (cene blaga so brez DDV), ki je veljaven na dan naročila kupca. Kupnino bo prodajalec v potrdilu naročila navedel po veljavnih pravnih predpisih vključno z DDV (pri dobavi blaga v Slovenski republiki). V nujnih primerih, kadar se kupnina določi kot samostojna cenovna kalkulacija na podlagi veljavnega cenika, kupec plača kupnino po cenovni kalkulaciji, ki jo prodajalec določi kot končni znesek kupnine glede na stroške, a ne sme biti višja od kupnine, ki je bila določena s kalkulacijo. Kupec ima pravico do popusta na ceno blaga v skladu z OKP. Če prodajalec spremeni v času trajanja OKP višino popusta za kupca pri ceni blaga, nemudoma kupca o tem dejstvu obvesti. Pri dobavi blaga v Slovenski republiki zaračuna prodajalec kupcu tudi DDV po veljavnih pravnih predpisih.
- Kupec ima za naročila blaga določen finančni kreditni limit in zapadlost računov v smislu OKP, prodajalec pa lahko fakturira kupnino kupcu z dnem dobave oziroma odpreme blaga. Po porabi kredita v smislu OKP ali v primeru neplačanega računa s strani kupca v roku zapadlosti, prodajalec lahko prekine dobavo blaga kupcu na podlagi pogodbe in ne potrdi drugega pisnega naročila kupca. S prekinjenimi dobavami blaga prodajalec nadaljuje:
 - v primeru prekoračitve kreditnega limita: s plačilom najstarejših računov do zneska preseženega kreditnega limita in plačilu vrednosti zahtevane odpreme blaga;
 - v primeru neplačanega zapadlega računa: po plačilu računa v celotni višini. Prodajalec lahko kadarkoli v času veljavnosti OKP spremeni kreditni limit kupca.
- Plačilo šteje za pravočasno v primeru priliva na račun prodajalca ali gotovinskega plačila v blagajni prodajalca do roka zapadlosti.
- Če kupec ne plača računa v roku zapadlosti, prodajalec lahko obračuna zamudne obresti v višini 0,05 % neplačanega zneska za vsak dan zamude.

IV. DOBAVA BLAGA IN PRIDRŽEK LASTNINE

- Prodajalec mora dobaviti blago kupcu v pogodbeno dogovorjeni količini, kakovosti in izvedbi, ki je primerna za namembno uporabo blaga. Dobavljeno blago prodajalca mora kupec prevzeti.
- Če se pogodbeni stranki nista dogovorili drugače, prodajalec mora blago zapakirati ali opremiti za prevoz na način, ki je običajen za zadevno blago v poslovnem stiku.
- Dobava blaga se izvede v roku in na način, ki sta ga pogodbeni strani dogovorili s pogodbo.
- Pri dobavi blaga prodajalcu mora zaposleni pri kupcu izkazati pravico do prevzema blaga.
- Če se blago izroča na sedežu prodajalca (oziroma v pripadajočem skladišču prodajalca, ki mu kupec predloži naročilnico) brez nakladanja na prevozno sredstvo, mora prevoznik, ki ga določi kupec, izkazati pravico do prevzema blaga.
- Če se blago dobavi kupcu na kraj dobave, ki je naveden v naročilu, z vozilom prodajalca, zaračuna prodajalec kupcu stroške prevoza po ceniku prevoza, ki je veljaven na dan predložitve naročila s strani kupca. Prodajalec si pridržuje pravico do razkladanja blaga samo v dostopnem terenu po njegovi presoji.
- Če ni določeno drugače, zaračuna prodajalec poštno stroške za pošiljanje blaga kupcu.
- Kupec se zavezuje, da bo v dobavnem roku blago prevzel. Če kupec obveznosti glede prevzema blaga v dobavnem roku ne izpolni, prodajalec ga pozove za izpolnitev obveznosti v dodatnem primernem roku. Če kupec blaga ne prevzame niti v dodatnem primernem roku, prodajalec lahko od pogodbe odstopi.
- Kupec, ki do dneva dobave blaga ne plača celotne kupnine, pridobi pravico do dobavljenega blaga šele s plačilom celotnega zneska kupnine.

V. PREHOD NEVARNOSTI ZA NASTANEK ŠKODE

- Nevarnost nastanka škode na blagu preide na kupca v trenutku prevzema blaga od prodajalca oziroma njegovega prevoznika; če kupec blaga ne prevzame pravočasno, preide nevarnost za nastanek škode na kupca v trenutku, ko prodajalec ali njegov prevoznik omogoči razpolaganje z blagom in kupec blaga ni prevzel ter je kršil pogodbo, čeprav je za možnost prevzema blaga vedel.
- Če prodajalec izroči blago za prevoz prevozniku, ki ga je določil kupec, na svojem sedežu v kraju Čachtice (oziroma v pripadajočem skladišču prodajalca), od katerega bo kupec blago prevzel, preide nevarnost za nastanek škode na kupca v trenutku izročitve blaga prevozniku.
- Če mora prodajalec odposlati blago kupcu, preide nevarnost za nastanek škode na blagu na kupca v trenutku izročitve blaga prvemu prevozniku za prevoz do namembnega kraja.
- Kupec mora pregledati blago takoj po prehodu nevarnosti za nastanek škode na blagu. Če se blago pošilja kupcu, mora blago pregledati takoj po dobavi v namembni kraj.

VI. ODGOVORNOST ZA NAPAKE IN GARANCIJA

- Prodajalec je odgovoren za napake blaga v trenutku prehoda nevarnosti za nastanek škode na kupca, četudi postane napaka očitna šele kasneje. Prodajalec je odgovoren tudi za vsako napako, ki nastane po prehodu nevarnosti nastanka škode na kupca, če škoda nastane zaradi kršitve njegovih obveznosti.
- Če kupec ne pregleda ali ne zagotovi pregleda blaga v času prehoda nevarnosti za nastanek škode na blagu, lahko uveljavi pravice za napake, ki bi jih lahko ugotovil ob takšnem pregledu, če izkaže obstoj takšne napake na blagu že v času prehoda nevarnosti za nastanek škode na blagu.
- Kupec mora prodajalcu sporočiti napake blaga takoj, ko
 - a/ bo ugotovil napako;
 - b/ bi moral ob strokovni skrbi napako ugotoviti ob pregledu, ki ga mora opraviti ob prehodu nevarnosti za nastanek škode ali
 - c/ bo napako ugotovil pozneje, najpozneje pa v dveh letih od časa dobave blaga oziroma dostave blaga na namembni kraj, ki je določen v pogodbi. Pri napakah, na katere se nanaša garancija za kakovost, velja namesto tega roka garancijski rok.
- Če prodajalec nudi kupcu garancijo za kakovost blaga, navede takšno izjavo v samostojnem garancijskem listu, v katerem navede tudi reklamacijski postopek.
- Garancijski rok prične teči z dnem dobave blaga. Če blago odpošilja prodajalec, garancijski rok teče od dneva dostave blaga na namembni kraj. Garancijski rok ne teče v času, kadar kupec ne more blaga uporabljati zaradi napak, za katere je odgovoren prodajalec.
- V primeru dobave blaga z napako kupcu je izključena uporaba določil 436. in 437. člena, drugega, tretjega in četrtega odstavka 439. člena in 441. člena Trgovskega zakonika, prodajalec v takšnem primeru nudi kupcu popust ali odstrani napake, ki jih kupec navaja:
 - a/ z dobavo manjkajočega blaga;
 - b/ s popravilom blaga ali dobavo nadomestnega blaga v primeru odstranljivih napakah ali
 - c/ dobavo nadomestnega blaga v primeru napak, ki jih ni mogoče odstraniti.
- Popust mora ustrezati razliki med vrednostjo, ki bi jo imelo blago brez napak, in vrednostjo, ki jo ima dobavljeno blago z napako, pri čemer je za določitev vrednosti odločen čas, ko bi morala biti izvedena redna dobava. Kupec, ki mu prodajalec nudi popust pri kupnini, ne more zahtevati nadomestila izgubljenega dohodka zaradi pomanjkljivih karakteristik blaga, na katerega se popust nanaša.
- Pri dobavi nadomestnega blaga lahko prodajalec zahteva, da mu kupec na njegove stroške vrne blago, ki je predmet zamenjave, in sicer v stanju, v kakršnem je bilo dobavljeno. To ne velja, če nezmožnost vračila blaga v tako navedenem stanju ni nastala z ravnanjem ali opustitvijo dolžnega ravnanja kupca, ali je sprememba stanja nastala zaradi rednega pregleda za namen ugotovitve napak blaga. Če pred odkritjem napak kupec blago ali del blaga proda ali blago v celoti ali delno porabi ali spremeni ob njegovi običajni uporabi, mora neprodano ali neuporabljeno ali spremenjeno blago vrniti in zagotoviti prodajalcu nadomestilo do višine, v kateri je imel iz navedene uporabe blaga korist.
- Odgovornost prodajalca za napake, na katere se ne nanaša garancija za kakovost, ne nastane, če so te napake nastale po prehodu nevarnosti za nastanek škode na blagu z zunanjimi dogodki in jih ni povzročil prodajalec ali osebe, s pomočjo katerih je izpolnjeval svojo obveznost.

VII. VIŠJA SILA

- Če po sklenitvi pogodbe nastanejo nepredvidene in nespremenljive okoliščine, ki pomenijo trajno ali začasno oviro za izpolnjevanje obveznosti pogodbenih strani iz sklenjene pogodbe (vis maior), neizpolnitev obveznosti (ob trajni oviri) pogodbenih strani oziroma pozna izpolnitev obveznosti (ob začasni oviri) ne pomeni kršitve te pogodbe, pogodbeni stranki pa ni odgovorna za morebitno škodo, ki bi lahko nastala v povezavi z neizpolnitvijo pogodbenih obveznosti. Če je ovira za izpolnjevanje obveznosti iz pogodbe samo začasna, pogodbeni stranki se zavezuje, da bosta pristopili k izpolnjevanju svojih obveznosti nemudoma po odpravi takšne ovire. Vsaka pogodbeni stranki mora nemudoma obvestiti drugo pogodbeno stran o nastanku zgoraj navedenih ovir.
- Kot vis maior štejejo zlasti naravne nesreče, samovoljno ravnanje tretjih oseb, stavke, delovne izločitve, blokade, vojne (napovedane in nenapovedane), spremenjena politična situacija, ki izključuje ali nesorazmerno otežuje izvajanje pravic in obveznosti iz pogodbe ali drugi podobni dogodki.

VIII. VARSTVO OSEBNIH PODATKOV

- Kupec (za namene tega člena tudi druga oseba, ki je podpisana v OKP in naročilu v imenu kupca) daje prodajalcu izrecno soglasje v smislu zakona št. 428/2002 Ur. l. o varstvu osebnih podatkov po veljavnem besedilu (v nadaljevanju samo »zakon«) z obdelavo osebnih podatkov, ki so navedeni v OKP in naročilu kupca.
 - 8.2. Kupec daje prodajalcu izrecno soglasje z obdelavo osebnih podatkov za namen:
 - a/ izvajanja pravic in obveznosti iz OKP in posamezne pogodbe;
 - b/ vodenja evidence, ki jo mora prodajalec voditi v skladu z zakonom ali na podlagi zakona;
 - c/ trženja.
 - 8.3. Kupec izrecno soglaša, da prodajalec lahko za namene iz alineje 8.2. posreduje njegove osebne podatke tretji osebi, ki jo je pooblastil za izvajanje zadevne dejavnosti.
 - 8.4. Kupec soglaša, da prodajalec obdeluje njegove osebne podatke:
 - a/ za čas, ko mora prodajalec voditi evidenco iz alineje 8.2. točka b);
 - b/ za nujno potreben čas za zaščito zakonskih pravic in pravno zagotovljenih interesov prodajalca.
 - 8.5. Kupec jemlje na znanje, da lahko svoje soglasje z obdelavo osebnih podatkov prekliche in zahteva uničenje svojih osebnih podatkov v primeru, da prodajalec oziroma tretje osebe, ki jim je prodajalec posredoval osebne podatke, kršijo zakonske obveznosti.

IX. KONČNA DOLOČILA

- Kupec ne more na tretjo osebo prenesti ali tretji osebi odstopiti pravic iz OKP ali posamezne pogodbe brez izrecnega soglasja prodajalca.
- Če ni s splošnimi poslovnimi pogoji določeno drugače, OKP se lahko spremeni samo s pisnimi aneksi, ki jih podpisajo predstavniki obeh pogodbenih strani.
- Drugečni dogovori iz posamezne pogodbe med prodajalcem in kupcem imajo prednost pred določili OKP in temi splošnimi poslovnimi pogoji. Pravna razmerja, ki niso urejena z OKP, posamezno pogodbo in splošnimi poslovnimi pogoji, se ravnajo po Trgovinskem zakoniku in drugih splošno zavezujočih pravnih predpisih Slovenske republike, pri čemer so izključena kolizijska pravila in uporaba Konvencije Združenih narodov o pogodbah o mednarodni prodaji blaga (CISG) z dne 11.04.1980 in njihovih morebitnih dodatkov v primeru, da ima kupec sedež (kraj poslovanja) v drugi državi ali se blago dobavlja v drugo državo.
- Vse spore, ki nastanejo na podlagi OKP, bodo pogodbeni strani reševale po mirni poti. Reševanje sporov, ki jih ne bo mogoče rešiti sporazumno, je v pristojnosti (izključno) pristojnega sodišča Slovenske republike.
- Te splošne pogoje izdaja prodajalec po 273. členu Trgovskega zakonika, in sicer z veljavnostjo od 01.01.2017