



**GALVA  
NIZED  
STEEL**

**PREPA  
INTED**

# GUTTER SYSTEM SEMI CIRCULAR – CIRCULAR



## PRICE LIST

2024

RECOMMENDED CONSUMER PRICES



POWERFUL PARTNER FOR YOUR ROOF



Prepainted galvanized steel | 3



Gutter | 6

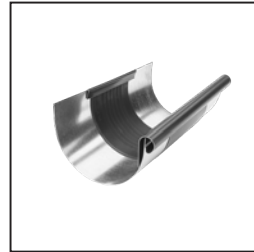

Gutter expanders | 12



Gutter accessories | 15



Gutter hook | 19



Corner | 24



End Cap | 26



Outlet | 28



Elbow | 40



Downpipe | 45



Downpipe accessories | 52



Pipe bracket | 55



Pipe bracket accessories | 59



Downpipe flap | 62



Protective gutter pipe | 66



**GALVA  
NIZED  
STEEL**

**PREPA  
INTED**

# GUTTER SYSTEM SEMI CIRCULAR – CIRCULAR

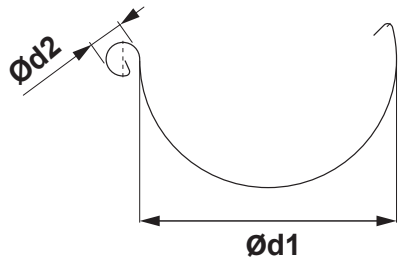

### ROOF GUTTER DIMENSIONS

(dimensions and dimensional tolerances according to EN 612)

Developed width (mm)	200	250	280	333	400	500
Ød1	80	105	127	153	192	250
Ød2	16	18	18	20	22	22

### INNER FOLD

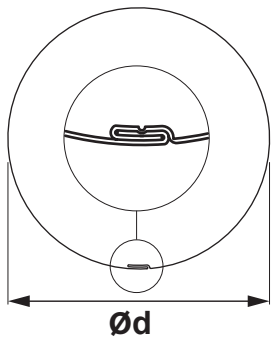

### SPOUT PIPE DIMENSIONS

(dimensions and dimensional tolerances according to EN 612)

Dimensions	60	80	100	120	150
Nominal size Ød (mm)	60	80	100	120	150

### GUTTER BRACKET DIMENSIONS

(dimensions and dimensional tolerances according to EN 612)

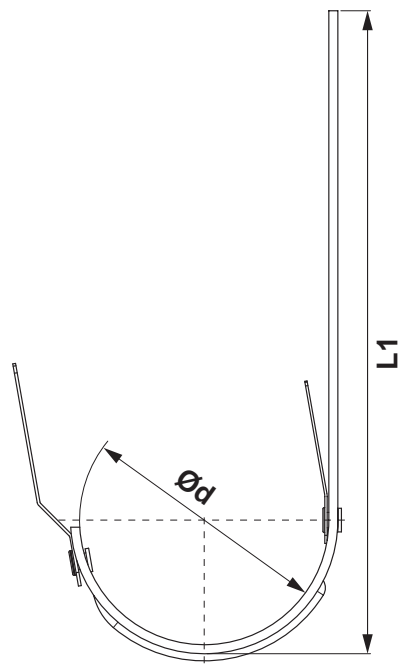

Dimensions (mm)	L1	Ød
200	290	80
250	310	105
280	345	127
333 – 550	385	153
333 – 610	445	153
400	400	192

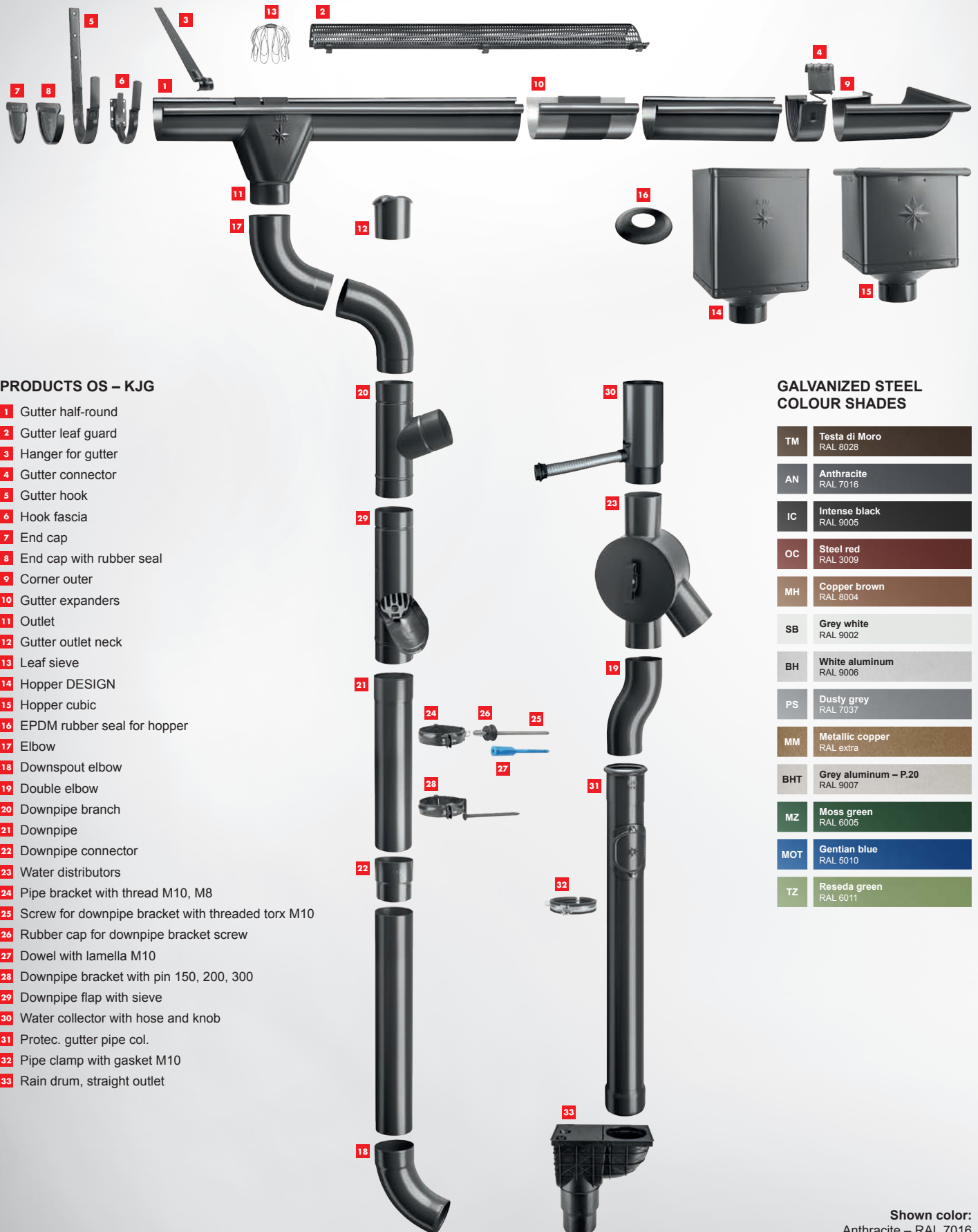

**PRODUCTS OS – KJG**

- 1** Gutter half-round
- 2** Gutter leaf guard
- 3** Hanger for gutter
- 4** Gutter connector
- 5** Gutter hook
- 6** Hook fascia
- 7** End cap
- 8** End cap with rubber seal
- 9** Corner outer
- 10** Gutter expanders
- 11** Outlet
- 12** Gutter outlet neck
- 13** Leaf sieve
- 14** Hopper DESIGN
- 15** Hopper cubic
- 16** EPDM rubber seal for hopper
- 17** Elbow
- 18** Downspout elbow
- 19** Double elbow
- 20** Downpipe branch
- 21** Downpipe
- 22** Downpipe connector
- 23** Water distributors
- 24** Pipe bracket with thread M10, M8
- 25** Screw for downpipe bracket with threaded torx M10
- 26** Rubber cap for downpipe bracket screw
- 27** Dowel with lamella M10
- 28** Downpipe bracket with pin 150, 200, 300
- 29** Downpipe flap with sieve
- 30** Water collector with hose and knob
- 31** Protec. gutter pipe col.
- 32** Pipe clamp with gasket M10
- 33** Rain drum, straight outlet

**GALVANIZED STEEL  
COLOUR SHADES**

TM	Testa di Moro RAL 8028
AN	Anthracite RAL 7016
IC	Intense black RAL 9005
OC	Steel red RAL 3009
MH	Copper brown RAL 8004
SB	Grey white RAL 9002
BH	White aluminum RAL 9006
PS	Dusty grey RAL 7037
MM	Metallic copper RAL extra
BHT	Grey aluminum – P.20 RAL 9007
MZ	Moss green RAL 6005
MOT	Gentian blue RAL 5010
TZ	Reseda green RAL 6011



# GALVANIZED STEEL POLYESTER

## TATA STEEL





The company Tata was founded in 1868 by Jamsetji Nusserwanji Tata and headquartered in India. It is a global business conglomerate operating in over 100 countries across 5 continents. From an early foray into steel and automobiles, to staying abreast of the latest technologies, the Tata Group today has a strong position across diverse industries such as agrochemicals, automotive, chemicals, construction, finance, consumer products and hospitality.

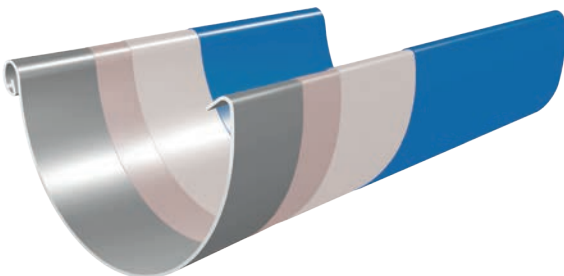

## MARCEGAGLIA

Marcegaglia is the Italian leading player and the largest independent global operator in the steel processing industry. With 5.6 million tons processed each year and turnover more than 5 billion euros (2017), Marcegaglia is an Italian industrial group, which is a leading player in Europe and worldwide in the transformation of steel. The acquired leadership is the result of a long, solid and steady growth path, which makes Marcegaglia the largest independent global player in steel transformation.





-  Top coating layer (approx. 20  $\mu\text{m}$ ) on a polyester base for excellent aesthetics and the highest resistance to damage
-  Primer (approx. 5  $\mu\text{m}$ ) for perfect adhesion and strong anti-corrosion protection
-  Zinc layer (225  $\text{g}/\text{m}^2$ ) for permanent anti-corrosion protection
-  Optimized steel coil for OS – KJG gutter system

# GALVANIZED STEEL POLYESTER

## GUTTER HALF-ROUND [s=0,55]

P-PZ

Nominal dimension	200	200	200
Length in m	2,0	3,0	4,0
Price in €/m	With VAT	With VAT	With VAT
<b>TM</b> 1 Testa di Moro RAL 8028	<b>8,34</b> 043610	<b>8,34</b> 043627	<b>8,34</b> 043634
<b>AN</b> 2 Anthracite RAL 7016	<b>8,34</b> 042187	<b>8,34</b> 042194	<b>8,34</b> 042200
<b>IC</b> 3 Intense black RAL 9005	<b>8,34</b> 042545	<b>8,34</b> 042552	<b>8,34</b> 042569
<b>OC</b> 4 Steel red RAL 3009		<b>8,34</b> 043191	<b>8,34</b> 043207
<b>MH</b> 5 Copper brown RAL 8004		<b>8,46</b> 042750	
<b>SB</b> 6 Grey white RAL 9002		<b>8,46</b> 043498	
<b>BH</b> 7 White aluminum RAL 9006		<b>8,46</b> 042392	<b>8,46</b> 042408
<b>PS</b> 8 Dusty grey RAL 7037		<b>8,46</b> 043375	<b>8,46</b> 043382
<b>MM</b> 9 Metallic copper RAL extra		<b>9,00</b> 042927	
<b>BHT – P.20</b> 10 Grey aluminum RAL 9007			
<b>MZ</b> 11 Moss green RAL 6005		<b>9,00</b> 043085	
<b>MOT</b> 12 Gentian blue RAL 5010		<b>9,00</b> 043016 *	
<b>TZ</b> 13 Reseda green RAL 6011		<b>9,00</b> 043825 *	
<b>Package in m</b> 	<b>10</b>	<b>15</b>	<b>20</b>
<b>Package in m</b> 	<b>800</b>	<b>1 200</b>	<b>1 600</b>

\* Custom production

GALV. STEEL  
POLYESTER



# GALVANIZED STEEL POLYESTER

## GUTTER HALF-ROUND [s=0,55]

P-PZ

Nominal dimension	250	250	250	250	250
Length in m	2,0	3,0	4,0	5,0	6,0
Price in €/m	With VAT	With VAT	With VAT	With VAT	With VAT
<b>TM</b> Testa di Moro RAL 8028	1 7,44	7,26	7,26	7,26	7,26
	043641	043658	043665	043672	043689
<b>AN</b> Anthracite RAL 7016	2 7,44	7,26	7,26	7,26	7,26
	042217	042224	042231	042248	042255
<b>IC</b> Intense black RAL 9005	3 7,44	7,26	7,26	7,26	7,26
	042576	042583	042590	042606	042613
<b>OC</b> Steel red RAL 3009	4 7,44	7,26	7,26	7,26	7,26
	043214	043221	043238	043245	043252
<b>MH</b> Copper brown RAL 8004	5 7,56	7,38	7,38	7,38	7,38
	042774	042781	042798	042804	042811
<b>SB</b> Grey white RAL 9002	6	7,38	7,38		7,38
		043504	043511		043528
<b>BH</b> White aluminum RAL 9006	7	7,38	7,38	7,38	7,38
		042415	042422	042439	042446
<b>PS</b> Dusty grey RAL 7037	8		7,38		7,38
			043399		043405
<b>MM</b> Metallic copper RAL extra	9		7,80		7,80
			042934		042941
<b>BHT – P.20</b> Grey aluminum RAL 9007	10		9,00		
			095466		
<b>MZ</b> Moss green RAL 6005	11		7,80		7,80
			043092		043108
<b>MOT</b> Gentian blue RAL 5010	12		7,80		
			043023		
<b>TZ</b> Reseda green RAL 6011	13		7,80		
			043832		
Package in m 	10	15	20	25	30
Package in m 	480	720	960	1 200	1 440



GALV. STEEL  
POLYESTER

# GALVANIZED STEEL POLYESTER

## GUTTER HALF-ROUND [s=0,55]

P-PZ

Nominal dimension	280	280	280	280	280
Length in m	2,0	3,0	4,0	5,0	6,0
Price in €/m	With VAT	With VAT	With VAT	With VAT	With VAT
<b>TM</b> 1 Testa di Moro RAL 8028	<b>8,40</b>	<b>8,22</b>	<b>8,22</b>	<b>8,22</b>	<b>8,22</b>
	043696	043702	043719	043726	043733
<b>AN</b> 2 Anthracite RAL 7016	<b>8,40</b>	<b>8,22</b>	<b>8,22</b>	<b>8,22</b>	<b>8,22</b>
	042262	042279	042286	042293	042309
<b>IC</b> 3 Intense black RAL 9005	<b>8,40</b>	<b>8,22</b>	<b>8,22</b>	<b>8,22</b>	<b>8,22</b>
	042620	042637	042644	042651	042668
<b>OC</b> 4 Steel red RAL 3009		<b>8,22</b>	<b>8,22</b>	<b>8,22</b>	<b>8,22</b>
		043269	043276	043283	043290
<b>MH</b> 5 Copper brown RAL 8004		<b>8,34</b>	<b>8,34</b>		<b>8,34</b>
		042828	042835		042842
<b>SB</b> 6 Grey white RAL 9002			<b>8,34</b>		<b>8,34</b>
			043535		043542
<b>BH</b> 7 White aluminum RAL 9006		<b>8,34</b>	<b>8,34</b>		<b>8,34</b>
		042453	042460		042477
<b>PS</b> 8 Dusty grey RAL 7037			<b>8,34</b>		<b>8,34</b>
			043412		043429
<b>MM</b> 9 Metallic copper RAL extra			<b>8,94</b>		<b>8,94</b>
			042958		042965
<b>BHT – P.20</b> 10 Grey aluminum RAL 9007			<b>10,08</b>		
			095473		
<b>MZ</b> 11 Moss green RAL 6005			<b>8,94</b>		<b>8,94</b>
			043115		043122
<b>MOT</b> 12 Gentian blue RAL 5010			<b>8,94</b>		
			043030		
<b>TZ</b> 13 Reseda green RAL 6011			<b>8,94</b>		
			043849		
Package in m 	10	15	20	25	30
Package in m 	420	630	840	1 050	1 260

GALV. STEEL  
POLYESTER





# GALVANIZED STEEL POLYESTER

## GUTTER HALF-ROUND [s=0,55]

P-PZ



Nominal dimension	333	333	333	333	333
Length in m	2,0	3,0	4,0	5,0	6,0
Price in €/m	With VAT	With VAT	With VAT	With VAT	With VAT
<b>TM</b> 1 Testa di Moro RAL 8028	<b>8,76</b>	<b>8,52</b>	<b>8,52</b>	<b>8,52</b>	<b>8,52</b>
	043740	043757	043764	043771	043788
<b>AN</b> 2 Anthracite RAL 7016	<b>8,76</b>	<b>8,52</b>	<b>8,52</b>	<b>8,52</b>	<b>8,52</b>
	042316	042323	042330	042347	042354
<b>IC</b> 3 Intense black RAL 9005	<b>8,76</b>	<b>8,52</b>	<b>8,52</b>	<b>8,52</b>	<b>8,52</b>
	042675	042682	042699	042705	042712
<b>OC</b> 4 Steel red RAL 3009	<b>8,76</b>	<b>8,52</b>	<b>8,52</b>	<b>8,52</b>	<b>8,52</b>
	043306	043313	043320	043337	043344
<b>MH</b> 5 Copper brown RAL 8004	<b>8,88</b>	<b>8,64</b>	<b>8,64</b>	<b>8,64</b>	<b>8,64</b>
	042859	042866	042873	042880	042897
<b>SB</b> 6 Grey white RAL 9002		<b>8,64</b>	<b>8,64</b>	<b>8,64</b>	<b>8,64</b>
		043559	043566	043573	043580
<b>BH</b> 7 White aluminum RAL 9006		<b>8,64</b>	<b>8,64</b>	<b>8,64</b>	<b>8,64</b>
		042484	042491	042507	042514
<b>PS</b> 8 Dusty grey RAL 7037		<b>8,64</b>	<b>8,64</b>	<b>8,64</b>	<b>8,64</b>
		043436	043443	043450	043467
<b>MM</b> 9 Metallic copper RAL extra			<b>9,96</b>	<b>9,96</b>	<b>9,96</b>
			042972	042989	042996
<b>BHT – P.20</b> 10 Grey aluminum RAL 9007			<b>10,20</b>		<b>10,20</b>
			095480		095497
<b>MZ</b> 11 Moss green RAL 6005			<b>9,96</b>	<b>9,96</b>	<b>9,96</b>
			043139	043146	043153
<b>MOT</b> 12 Gentian blue RAL 5010			<b>9,96</b>		<b>9,96</b>
			043047		043054
<b>TZ</b> 13 Reseda green RAL 6011			<b>9,96</b>		
			043856		
Package in m 	<b>10</b>	<b>15</b>	<b>20</b>	<b>25</b>	<b>30</b>
Package in m 	<b>330</b>	<b>495</b>	<b>660</b>	<b>825</b>	<b>990</b>



# GALVANIZED STEEL POLYESTER

## GUTTER HALF-ROUND [s=0,55]

P-PZ

Nominal dimension	400	400	500	500	333
Length in m	4,0	6,0	4,0	6,0	7,0
Price in €/m	With VAT	With VAT	With VAT	With VAT	With VAT
<b>TM</b> 1 Testa di Moro RAL 8028	<b>13,74</b>	<b>13,74</b>			<b>8,52</b>
	043801	043818			043795 *
<b>AN</b> 2 Anthracite RAL 7016	<b>13,74</b>	<b>13,74</b>	<b>18,60</b>	<b>18,60</b>	
	042361	042378	086730 *	086747 *	
<b>IC</b> 3 Intense black RAL 9005	<b>13,74</b>	<b>13,74</b>			
	042729	042736			
<b>OC</b> 4 Steel red RAL 3009	<b>13,74</b>	<b>13,74</b>			
	043351	043368			
<b>MH</b> 5 Copper brown RAL 8004	<b>13,86</b>	<b>13,86</b>			
	042903	042910			
<b>SB</b> 6 Grey white RAL 9002	<b>13,86</b>	<b>13,86</b>	<b>18,72</b>	<b>18,72</b>	
	043597	043603	086778 *	086785 *	
<b>BH</b> 7 White aluminum RAL 9006	<b>13,86</b>	<b>13,86</b>	<b>18,72</b>	<b>18,72</b>	
	042521	042538	086754 *	086761 *	
<b>PS</b> 8 Dusty grey RAL 7037	<b>13,86</b>	<b>13,86</b>			
	043474	043481			
<b>MM</b> 9 Metallic copper RAL extra	<b>14,58</b>				
	043009				
<b>BHT – P.20</b> 10 Grey aluminum RAL 9007		<b>15,36</b>			
		095503			
<b>MZ</b> 11 Moss green RAL 6005	<b>14,58</b>	<b>14,58</b>			
	043160	043177 *			
<b>MOT</b> 12 Gentian blue RAL 5010	<b>14,58</b>	<b>14,58</b>			
	043061	043078			
<b>TZ</b> 13 Reseda green RAL 6011	<b>14,58</b>				
	043863 *				
Package in m 	<b>20</b>	<b>30</b>	<b>20</b>	<b>30</b>	<b>35</b>
Package in m 	<b>540</b>	<b>810</b>	<b>–</b>	<b>–</b>	<b>1 155</b>

\* Custom production

GALV. STEEL  
POLYESTER



# GALVANIZED STEEL POLYESTER

## GUTTER ON-ROOF [s=0,55]

P-PZS

Nominal dimension	650	650
Length in m	4,0	6,0
Price in €/m	With VAT	With VAT
<b>TM</b> 1 Testa di Moro RAL 8028	<b>26,40</b> 049926	<b>26,40</b> 049933
<b>AN</b> 2 Anthracite RAL 7016	<b>26,40</b> 049759	<b>26,40</b> 049766
<b>IC</b> 3 Intense black RAL 9005	<b>26,40</b> 049797	<b>26,40</b> 049803
<b>OC</b> 4 Steel red RAL 3009	<b>26,40</b> 049865	<b>26,40</b> 049872
<b>MH</b> 5 Copper brown RAL 8004	<b>27,36</b> 049810	<b>27,36</b> 049827
<b>SB</b> 6 Grey white RAL 9002	<b>27,36</b> 049902	
<b>BH</b> 7 White aluminum RAL 9006	<b>27,36</b> 049773	<b>27,36</b> 049780
<b>PS</b> 8 Dusty grey RAL 7037	<b>27,36</b> 049889	
<b>MM</b> 9 Metallic copper RAL extra	<b>30,24</b> 049834	
<b>BHT – P.20</b> 10 Grey aluminum RAL 9007	<b>35,10</b> 095749 *	
<b>MZ</b> 11 Moss green RAL 6005	<b>30,24</b> 049858	
<b>MOT</b> 12 Gentian blue RAL 5010	<b>30,24</b> 049841 *	
<b>TZ</b> 13 Reseda green RAL 6011	<b>30,24</b> 049940 *	
Package in m 	4	6
Package in m 	200	300

\* Custom production



# GALVANIZED STEEL POLYESTER

## GUTTER EXPANDERS

P-PZDI

Nominal dimension	250/260	280/260	333/260	400/260
Price in €/pcs	With VAT	With VAT	With VAT	With VAT
<b>TM</b> 1 Testa di Moro RAL 8028	17,52	18,60	20,28	23,88
	013064	013071	013088	013095
<b>AN</b> 2 Anthracite RAL 7016	17,52	18,60	20,28	23,88
	012661	012678	012685	012692
<b>IC</b> 3 Intense black RAL 9005	17,52	18,60	20,28	23,88
	012746 *	012753 *	012760	012777 *
<b>OC</b> 4 Steel red RAL 3009	17,52	18,60	20,28	23,88
	012944 *	012951 *	012968 *	012975 *
<b>MH</b> 5 Copper brown RAL 8004	17,52	18,60	20,28	23,88
	012784 *	012791 *	012807 *	012814 *
<b>SB</b> 6 Grey white RAL 9002	17,52	18,60	20,28	23,88
	013026 *	013033 *	013040 *	013057 *
<b>BH</b> 7 White aluminum RAL 9006	17,52	18,60	20,28	23,88
	012708 *	012715 *	012722 *	012739 *
<b>PS</b> 8 Dusty grey RAL 7037	17,52	18,60	20,28	23,88
	012982 *	012999 *	013002 *	013019 *
<b>MM</b> 9 Metallic copper RAL extra	17,52	18,60	20,28	23,88
	012821 *	012838 *	012845 *	012852 *
<b>BHT – P.20</b> 10 Grey aluminum RAL 9007	17,52	18,60	20,28	23,88
	096098 *	096104 *	096111 *	114044 *
<b>MZ</b> 11 Moss green RAL 6005	17,52	18,60	20,28	23,88
	012906 *	012913 *	012920 *	012937 *
<b>MOT</b> 12 Gentian blue RAL 5010	17,52	18,60	20,28	23,88
	012869 *	012876 *	012883 *	012890 *
<b>TZ</b> 13 Reseda green RAL 6011	17,52	18,60	20,28	23,88
	013101 *	013118 *	013125 *	013132 *
<b>Package in pcs</b>	3	3	5	5
<b>Package in pcs</b>	360	360	200	200

\* Custom production

GALV. STEEL  
POLYESTER

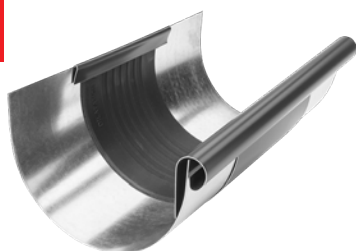



# GALVANIZED STEEL POLYESTER

## ON-ROOF GUTTER EXPANSION COMPONENT

P-PZSDI





Nominal dimension	670/260	
Price in €/pcs	With VAT	
<b>TM</b> 1 Testa di Moro RAL 8028	<b>37,80</b>	013637 *
<b>AN</b> 2 Anthracite RAL 7016	<b>37,80</b>	013545 *
<b>IC</b> 3 Intense black RAL 9005	<b>37,80</b>	013569 *
<b>OC</b> 4 Steel red RAL 3009	<b>37,80</b>	013606 *
<b>MH</b> 5 Copper brown RAL 8004	<b>37,80</b>	013576 *
<b>SB</b> 6 Grey white RAL 9002	<b>37,80</b>	013620 *
<b>BH</b> 7 White aluminum RAL 9006	<b>37,80</b>	013552 *
<b>PS</b> 8 Dusty grey RAL 7037	<b>37,80</b>	013613 *
<b>MM</b> 9 Metallic copper RAL extra	<b>37,80</b>	013583 *
<b>BHT – P.20</b> 10 Grey aluminum RAL 9007	<b>37,80</b>	096067 *
<b>MZ</b> 11 Moss green RAL 6005	<b>37,80</b>	013651 *
<b>MOT</b> 12 Gentian blue RAL 5010	<b>37,80</b>	013590 *
<b>TZ</b> 13 Reseda green RAL 6011	<b>37,80</b>	013644 *
Package in pcs 	1	
Package in pcs 	40	

\* Custom production

## ENDLESS TAPES

P-PZDIP



Nominal dimension	Lenght in m	EAN product number	Packaging in m		Cena with VAT [€/m]
					
260	3,0	012470	3	120	33,60
260	6,0	012487	6	240	33,60

## USE OF DILATATION GUTTER AND DILATATION STRIP

### DILATATION GUTTER

**Installation example: hanging gutter with a developed width of up to 500 mm.** The dilatation gutter shall be installed at spacing of 15 m. For outer corner and beginning of the gutter, a half of the standard value is applied: maximum 7,5 m. For inner corner, a quarter of the standard value is applied: maximum 3,75 m. For other materials and dimensions: see the table below. Corners are always taken into account as fixed points.

### ROOF SEMICIRCULAR DILATATION GUTTERS

Developed gutter width	Aluminium	Steel, Titanium-zinc, Copper, Stainless steel
< 500	12	15
> 500	8	10

### DILATATION STRIP

**Indoor installation:** on gutters attached without gluing to a substrate, roofs with non-standard profile and roof cladding

### ROOF DILATATION STRIP

Developed gutter width	Aluminium	Steel, Titanium-zinc, Copper, Stainless steel
< 500	8	10
> 500	6	8

For outer corner or the beginning of the gutter, a half of the standard value shall be applied.

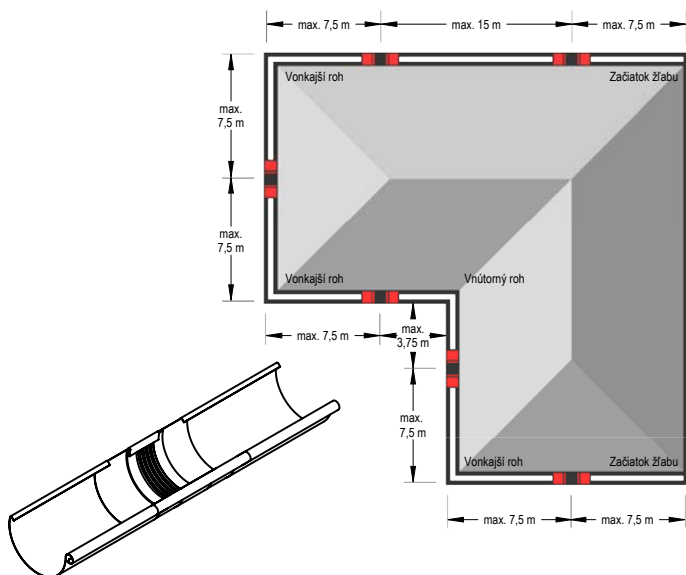

#### Note to the dilatation gutter mounting.

When mounting by soldering, first cover the middle rubber part with a wet cloth (to prevent heat transfer to the middle rubber part). A minimum distance of 6 cm from the middle rubber part must be kept. In any case avoid contact of rubber with open flame.

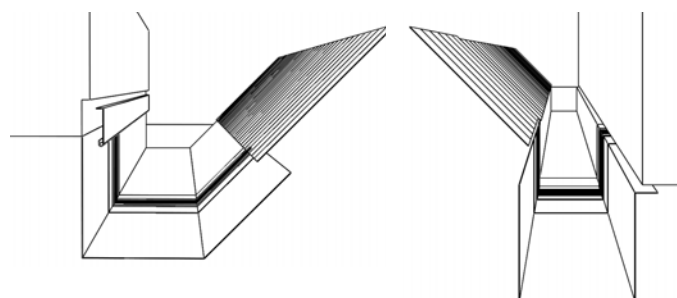

#### Note to the dilatation strip mounting.

**When bending and mounting dilatation elements, make sure that:**

- Bending jaws have a radius of at least 2 mm.
- For sheet metal thicknesses over 1 mm, it must be observed bending radius at least 5 mm.
- When bending, the bending jaws should be set to a thickness of the middle rubber part of 3 to 4 mm to prevent the cutting effect - damage to the rubber.
- The rubber middle part must not be compressed or damaged during bending. Therefore, an aluminium sheet strip 2 to 5 mm (thick) should be used, bent so that it can be attached as a protection to the bending jaws. This achieves a larger bending radius and prevents the rubber middle part from breaking.

## ALUMINIUM GUTTER LEAF GUARD

P-PZNL M

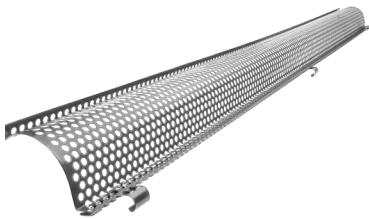





Nominal dimension		<b>333</b>
Length in m		<b>2,0</b>
Price in €/pcs		With VAT
<b>TM</b> 1 Testa di Moro RAL 8028		<b>31,80</b> 064943
<b>AN</b> 2 Anthracite RAL 7016		<b>31,80</b> 064912
<b>IC</b> 3 Intense black RAL 9005		<b>31,80</b> 064929 *
<b>OC</b> 4 Steel red RAL 3009		<b>31,80</b> 064936 *
<b>MH</b> 5 Copper brown RAL 8004		<b>31,80</b> 119766 *
<b>SB</b> 6 Grey white RAL 9002		<b>31,80</b> 117762 *
<b>BH</b> 7 White aluminum RAL 9006		<b>31,80</b> 117717 *
<b>PS</b> 8 Dusty grey RAL 7037		<b>31,80</b> 117755 *
<b>MM</b> 9 Metallic copper RAL extra		<b>31,80</b> 117724 *
<b>BHT – P.20</b> 10 Grey aluminum RAL 9007		<b>31,80</b> 097156 *
<b>MZ</b> 11 Moss green RAL 6005		<b>31,80</b> 117748 *
<b>MOT</b> 12 Gentian blue RAL 5010		<b>31,80</b> 117731 *
<b>TZ</b> 13 Reseda green RAL 6011		<b>31,80</b> 117779 *
Package in pcs		<b>15</b>
Package in pcs		<b>120</b>

\* Custom production

# GALVANIZED STEEL POLYESTER



## PVC GUTTER GUARD

## SD-ZNL MRIEZKA

Nominal dimension	Lenght in m	EAN product number	Packaging in pcs		Price with VAT [€/pcs]
					
 171	1,0	008473	30	450	<b>5,40</b>
 171	1,0	008466	30	450	<b>5,40</b>

## PVC GUTTER GUARD

## SD-ZNL N

Nominal dimension	Lenght in m	EAN product number	Packaging in pcs		Price with VAT [€/pcs]
					
250	3,0	008480	10	400	<b>28,68</b>
280-333	3,0	008497	10	400	<b>28,80</b>

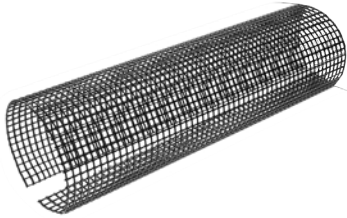
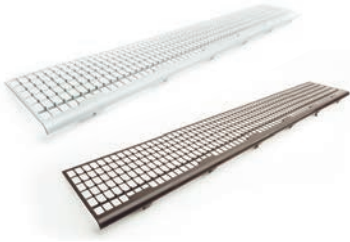





# GALVANIZED STEEL POLYESTER

## HANGER FOR GUTTER

P-PDZNV

Nominal dimension	250-280	333	400
Dimension in mm	18	20	22
Price in €/pcs	With VAT	With VAT	With VAT
<b>TM</b> 1 Testa di Moro RAL 8028	<b>1,92</b> 085665	<b>1,92</b> 085672	<b>1,92</b> 085689 *
<b>AN</b> 2 Anthracite RAL 7016	<b>1,92</b> 085290	<b>1,92</b> 085306	<b>1,92</b> 085313
<b>IC</b> 3 Intense black RAL 9005	<b>1,92</b> 085351	<b>1,92</b> 085368	<b>1,92</b> 085375 *
<b>OC</b> 4 Steel red RAL 3009	<b>1,92</b> 085504	<b>1,92</b> 085573	<b>1,92</b> 085597 *
<b>MH</b> 5 Copper brown RAL 8004	<b>1,92</b> 085382	<b>1,92</b> 085399	<b>1,92</b> 085405 *
<b>SB</b> 6 Grey white RAL 9002	<b>1,92</b> 085634 *	<b>1,92</b> 085641	<b>1,92</b> 085658 *
<b>BH</b> 7 White aluminum RAL 9006	<b>1,92</b> 085320	<b>1,92</b> 085337	<b>1,92</b> 085344 *
<b>PS</b> 8 Dusty grey RAL 7037	<b>1,92</b> 085603	<b>1,92</b> 085610	<b>1,92</b> 085627 *
<b>MM</b> 9 Metallic copper RAL extra	<b>1,92</b> 085412 *	<b>1,92</b> 085429	<b>1,92</b> 085436 *
<b>BHT – P.20</b> 10 Grey aluminum RAL 9007	<b>1,92</b> 094636 *	<b>1,92</b> 094643 *	<b>1,92</b> 094650 *
<b>MZ</b> 11 Moss green RAL 6005	<b>1,92</b> 085474 *	<b>1,92</b> 085481 *	<b>1,92</b> 085498 *
<b>MOT</b> 12 Gentian blue RAL 5010	<b>1,92</b> 085443 *	<b>1,92</b> 085450 *	<b>1,92</b> 085467 *
<b>TZ</b> 13 Reseda green RAL 6011	<b>1,92</b> 085696 *	<b>1,92</b> 085702 *	<b>1,92</b> 085719 *
<b>Package in pcs</b> 	<b>25</b>	<b>25</b>	<b>25</b>
<b>Package in pcs</b> 	<b>3 000</b>	<b>3 000</b>	<b>3 000</b>

\* Custom production



# GALVANIZED STEEL POLYESTER

## GUTTER CONNECTOR

## P-PSPZ

Nominal dimension	250	280	333
Price in €/pcs	With VAT	With VAT	With VAT
<b>TM</b> 1 Testa di Moro RAL 8028	<b>4,56</b> 083852	<b>4,56</b> 083869	<b>4,80</b> 083876
<b>AN</b> 2 Anthracite RAL 7016	<b>4,56</b> 083456	<b>4,56</b> 083463	<b>4,80</b> 083470
<b>IC</b> 3 Intense black RAL 9005	<b>4,56</b> 083531	<b>4,56</b> 083548	<b>4,80</b> 083555
<b>OC</b> 4 Steel red RAL 3009	<b>4,56</b> 083739	<b>4,56</b> 083746	<b>4,80</b> 083753
<b>MH</b> 5 Copper brown RAL 8004	<b>4,56</b> 083579	<b>4,56</b> 083586	<b>4,80</b> 083593
<b>SB</b> 6 Grey white RAL 9002	<b>4,56</b> 083814	<b>4,56</b> 083821	<b>4,80</b> 083838
<b>BH</b> 7 White aluminum RAL 9006	<b>4,56</b> 083494	<b>4,56</b> 083500	<b>4,80</b> 083517
<b>PS</b> 8 Dusty grey RAL 7037	<b>4,56</b> 083777	<b>4,56</b> 083784	<b>4,80</b> 083791
<b>MM</b> 9 Metallic copper RAL extra	<b>4,56</b> 083616	<b>4,56</b> 083623	<b>4,80</b> 083630
<b>BHT – P.20</b> 10 Grey aluminum RAL 9007	<b>4,56</b> 094681	<b>4,56</b> 094698 *	<b>4,80</b> 094704
<b>MZ</b> 11 Moss green RAL 6005	<b>4,56</b> 083692	<b>4,56</b> 083708	<b>4,80</b> 083715
<b>MOT</b> 12 Gentian blue RAL 5010	<b>4,56</b> 083654	<b>4,56</b> 083661	<b>4,80</b> 083678
<b>TZ</b> 13 Reseda green RAL 6011	<b>4,56</b> 083890 *	<b>4,56</b> 083906 *	<b>4,80</b> 083913
<b>Package in pcs</b>	<b>5</b>	<b>5</b>	<b>5</b>
<b>Package in pcs</b>	<b>600</b>	<b>600</b>	<b>600</b>



\* Custom production

GALV. STEEL  
POLYESTER



## GUTTER HOOK

P-PHP

Nominal dimension	200/380	250/430	280/480	280/480
Material	25/4	25/5	25/5	30/5
Price in €/pcs	With VAT	With VAT	With VAT	With VAT
<b>TM</b> 1 Testa di Moro RAL 8028	<b>3,96</b> 045362	<b>3,54</b> 045379	<b>3,78</b> 045386	<b>4,14</b> 045393
<b>AN</b> 2 Anthracite RAL 7016	<b>3,96</b> 044648	<b>3,54</b> 044655	<b>3,78</b> 044662	<b>4,14</b> 044679
<b>IC</b> 3 Intense black RAL 9005	<b>3,96</b> 044808	<b>3,54</b> 044815	<b>3,78</b> 044822	<b>4,14</b> 044839
<b>OC</b> 4 Steel red RAL 3009	<b>3,96</b> 045140	<b>3,54</b> 045157	<b>3,78</b> 045164	<b>4,14</b> 045171
<b>MH</b> 5 Copper brown RAL 8004	<b>3,96</b> 044884	<b>3,54</b> 044891	<b>3,78</b> 044907	<b>4,14</b> 044914
<b>SB</b> 6 Grey white RAL 9002	<b>3,96</b> 045287	<b>3,54</b> 045294	<b>3,78</b> 045300	<b>4,14</b> 045317
<b>BH</b> 7 White aluminum RAL 9006	<b>3,96</b> 044723	<b>3,54</b> 044730	<b>3,78</b> 044747	<b>4,14</b> 044754
<b>PS</b> 8 Dusty grey RAL 7037	<b>3,96</b> 045225	<b>3,54</b> 045232		<b>4,14</b> 045249
<b>MM</b> 9 Metallic copper RAL extra	<b>3,96</b> 044969	<b>3,54</b> 044976		<b>4,14</b> 044983
<b>BHT – P.20</b> 10 Grey aluminum RAL 9007		<b>3,54</b> 095961		<b>4,14</b> 095978
<b>MZ</b> 11 Moss green RAL 6005	<b>3,96</b> 045089	<b>3,54</b> 045096		<b>4,14</b> 045102
<b>MOT</b> 12 Gentian blue RAL 5010	<b>3,96</b> 045027	<b>3,54</b> 045034		<b>4,14</b> 045041
<b>TZ</b> 13 Reseda green RAL 6011	<b>3,96</b> 045454 *	<b>3,54</b> 045461		<b>4,14</b> 045478
Package in pcs 	<b>25</b>	<b>25</b>	<b>25</b>	<b>25</b>
Package in pcs 	<b>1 000</b>	<b>1 000</b>	<b>1 000</b>	<b>1 000</b>

\* Custom production



# GALVANIZED STEEL POLYESTER

## GUTTER HOOK

P-PHP

Nominal dimension	333/550	333/550	333/550	333/610	400/610
Material	25/5	30/4	30/5	30/5	25/5
Price in €/pcs	With VAT	With VAT	With VAT	With VAT	With VAT
<b>TM</b> 1 Testa di Moro RAL 8028	3,78	3,96	4,20	4,92	7,08
	045409	045416 *	045423	045430	045447
<b>AN</b> 2 Anthracite RAL 7016	3,78	3,96	4,20	4,92	7,08
	044686	080127 *	044693	044709	044716
<b>IC</b> 3 Intense black RAL 9005	3,78		4,20	4,92	7,08
	044846		044853	044860	044877
<b>OC</b> 4 Steel red RAL 3009	3,78		4,20	4,92	7,08
	045188		045195	045201	045218
<b>MH</b> 5 Copper brown RAL 8004	3,78		4,20	4,92	7,08
	044921		044938	044945	044952
<b>SB</b> 6 Grey white RAL 9002	3,78		4,20	4,92	7,08
	045324		045331	045348	045355
<b>BH</b> 7 White aluminum RAL 9006	3,78		4,20	4,92	7,08
	044761		044778	044785	044792
<b>PS</b> 8 Dusty grey RAL 7037			4,20	4,92	7,08
			045256	045263	045270
<b>MM</b> 9 Metallic copper RAL extra			4,20	4,92	7,08
			044990	045003	045010
<b>BHT – P.20</b> 10 Grey aluminum RAL 9007			4,20		7,08
			095985		095992
<b>MZ</b> 11 Moss green RAL 6005			4,20	4,92	7,08
			045119	045126	045133
<b>MOT</b> 12 Gentian blue RAL 5010			4,20	4,92	7,08
			045058	045065	045072
<b>TZ</b> 13 Reseda green RAL 6011			4,20	4,92	7,08
			045485	045492	045508 *
<b>Package in pcs</b>	25	25	25	25	25
<b>Package in pcs</b>	1 000	1 000	1 000	1 000	500

\* Custom production



GALV. STEEL  
POLYESTER



# GALVANIZED STEEL POLYESTER

## GUTTER HOOK WITH A NOSE

P-PHPN

Nominal dimension	250/430	280/480	333/550
Material	25/5	25/5	30/5
Price in €/pcs	With VAT	With VAT	With VAT
<b>TM</b> 1 Testa di Moro RAL 8028	<b>3,48</b> 095930	<b>3,48</b> 095947	<b>3,84</b> 095954
<b>AN</b> 2 Anthracite RAL 7016	<b>3,48</b> 095824	<b>3,48</b> 095831	<b>3,84</b> 095848
<b>IC</b> 3 Intense black RAL 9005		<b>3,48</b> 095879	<b>3,84</b> 095886 *
<b>MH</b> 5 Copper brown RAL 8004		<b>3,48</b> 095893	<b>3,84</b> 095909
<b>SB</b> 6 Grey white RAL 9002		<b>3,48</b> 095916	<b>3,84</b> 095923 *
<b>BH</b> 7 White aluminum RAL 9006		<b>3,48</b> 095855	<b>3,84</b> 095862
<b>PS</b> 8 Dusty grey RAL 7037			<b>3,84</b> 117496 *
Package in pcs 	25	25	25
Package in pcs 	1 000	1 000	1 000

\* Custom production

## GUTTER HOOK FASCIA WITH A NOSE

P-PHPNK

Nominal dimension	250	280	333
Material	25/4	25/4	25/5
Price in €/pcs	With VAT	With VAT	With VAT
<b>TM</b> 1 Testa di Moro RAL 8028	<b>3,78</b> 095435	<b>4,02</b> 095442	<b>4,26</b> 095459
<b>AN</b> 2 Anthracite RAL 7016	<b>3,78</b> 095312	<b>4,02</b> 095329	<b>4,26</b> 095336
<b>IC</b> 3 Intense black RAL 9005	<b>3,78</b> 095374	<b>4,02</b> 095381	<b>4,26</b> 095398
<b>MH</b> 5 Copper brown RAL 8004	<b>3,78</b> 095404	<b>4,02</b> 095411	<b>4,26</b> 095428
<b>BH</b> 7 White aluminum RAL 9006	<b>3,78</b> 095343 *	<b>4,02</b> 095350	<b>4,26</b> 095367
Package in pcs 	25	25	25
Package in pcs 	1 000	1 000	1 000



\* Custom production



# GALVANIZED STEEL POLYESTER

## ON-ROOF GUTTER HOOK WITH SUPPORT

P-PHSSN

Nominal dimension		4
Material		20/6
Price in €/pcs		With VAT
<b>TM</b> 1 Testa di Moro RAL 8028		<b>10,32</b> 033567
<b>AN</b> 2 Anthracite RAL 7016		<b>10,32</b> 033468
<b>IC</b> 3 Intense black RAL 9005		<b>10,32</b> 033482
<b>OC</b> 4 Steel red RAL 3009		<b>10,32</b> 033536
<b>MH</b> 5 Copper brown RAL 8004		<b>10,32</b> 033499
<b>SB</b> 6 Grey white RAL 9002		<b>10,32</b> 033550
<b>BH</b> 7 White aluminum RAL 9006		<b>10,32</b> 033475
<b>PS</b> 8 Dusty grey RAL 7037		<b>10,32</b> 033543
<b>MM</b> 9 Metallic copper RAL extra		<b>10,32</b> 033505
<b>BHT – P.20</b> 10 Grey aluminum RAL 9007		<b>10,32</b> 095510 *
<b>MZ</b> 11 Moss green RAL 6005		<b>10,32</b> 033529
<b>MOT</b> 12 Gentian blue RAL 5010		<b>10,32</b> 033512 *
<b>TZ</b> 13 Reseda green RAL 6011		<b>10,32</b> 033574
Package in pcs 		25
Package in pcs 		1 000

\* Custom production

GALV. STEEL  
POLYESTER



# GALVANIZED STEEL POLYESTER

## HOOK FASCIA

## P-PHPK



Nominal dimension	200	250	280	333	400
Material	25/4	25/4	25/4	25/5	30/5
Price in €/pcs	With VAT	With VAT	With VAT	With VAT	With VAT
<b>TM</b> 1 Testa di Moro RAL 8028	<b>4,32</b>	<b>4,08</b>	<b>4,38</b>	<b>4,74</b>	<b>6,60</b>
	065551	065568	065575	065582	065599
<b>AN</b> 2 Anthracite RAL 7016	<b>4,32</b>	<b>4,08</b>	<b>4,38</b>	<b>4,74</b>	<b>6,60</b>
	065056	065063	065070	065087	065094
<b>IC</b> 3 Intense black RAL 9005	<b>4,32</b>	<b>4,08</b>	<b>4,38</b>	<b>4,74</b>	<b>6,60</b>
	065155	065162	065179	065186	065193 *
<b>OC</b> 4 Steel red RAL 3009	<b>4,32</b>	<b>4,08</b>	<b>4,38</b>	<b>4,74</b>	<b>6,60</b>
	065407	065414	065421	065438	065445
<b>MH</b> 5 Copper brown RAL 8004	<b>4,32</b>	<b>4,08</b>	<b>4,38</b>	<b>4,74</b>	<b>6,60</b>
	065209	065216	065223	065230	065247 *
<b>SB</b> 6 Grey white RAL 9002	<b>4,32</b>	<b>4,08</b>	<b>4,38</b>	<b>4,74</b>	<b>6,60</b>
	065506	065513	065520	065537	065544
<b>BH</b> 7 White aluminum RAL 9006	<b>4,32</b>	<b>4,08</b>	<b>4,38</b>	<b>4,74</b>	<b>6,60</b>
	065100	065117	065124	065131	065148
<b>PS</b> 8 Dusty grey RAL 7037	<b>4,32</b>	<b>4,08</b>	<b>4,38</b>	<b>4,74</b>	<b>6,60</b>
	065452	065469	065476	065483	065490
<b>MM</b> 9 Metallic copper RAL extra	<b>4,32</b>	<b>4,08</b>	<b>4,38</b>	<b>4,74</b>	<b>6,60</b>
	065254	065261	065278	065285	065292 *
<b>BHT – P.20</b> 10 Grey aluminum RAL 9007		<b>4,08</b>	<b>4,38</b>	<b>4,74</b>	
		095251	095268	095275	
<b>MZ</b> 11 Moss green RAL 6005	<b>4,32</b>	<b>4,08</b>	<b>4,38</b>	<b>4,74</b>	<b>6,60</b>
	065353	065360	065377	065384	065391 *
<b>MOT</b> 12 Gentian blue RAL 5010	<b>4,32</b>	<b>4,08</b>	<b>4,38</b>	<b>4,74</b>	<b>6,60</b>
	065308 *	065315	065322	065339	065346
<b>TZ</b> 13 Reseda green RAL 6011	<b>4,32</b>	<b>4,08</b>	<b>4,38</b>	<b>4,74</b>	<b>6,60</b>
	065605 *	065612 *	065629 *	065636 *	065643 *
Package in pcs	<b>25</b>	<b>25</b>	<b>25</b>	<b>25</b>	<b>20</b>
Package in pcs	<b>1 000</b>	<b>1 000</b>	<b>1 000</b>	<b>1 000</b>	<b>800</b>

\* Custom production

# GALVANIZED STEEL POLYESTER

## CORNER OUTER

P-PRA

Nominal dimension	200	250	280	333	400
Price in €/pcs	With VAT	With VAT	With VAT	With VAT	With VAT
<b>TM</b> 1 Testa di Moro RAL 8028	14,28	14,04	14,16	14,28	35,88
	075673	075680	075697	075703	075710
<b>AN</b> 2 Anthracite RAL 7016	14,28	14,04	14,16	14,28	35,88
	075178	075185	075192	075208	075215
<b>IC</b> 3 Intense black RAL 9005	14,28	14,04	14,16	14,28	35,88
	075260	075284	075291	075307	075314
<b>OC</b> 4 Steel red RAL 3009	14,28	14,04	14,16	14,28	35,88
	075529	075536	075543	075567	075550
<b>MH</b> 5 Copper brown RAL 8004	14,28	14,04	14,16	14,28	35,88
	075321	075338	075345	075352	075369
<b>SB</b> 6 Grey white RAL 9002	14,28	14,04	14,16	14,28	35,88
	075635	075628	075642	075659	075666
<b>BH</b> 7 White aluminum RAL 9006	14,28	14,04	14,16	14,28	35,88
	075222	075239	075246	075253	075277
<b>PS</b> 8 Dusty grey RAL 7037	14,28	14,04	14,16	14,28	35,88
	075574	075581	075598	075604	075611
<b>MM</b> 9 Metallic copper RAL extra	14,28	14,04	14,16	14,28	35,88
	075376	075383	075390	075406	075413
<b>BHT – P.20</b> 10 Grey aluminum RAL 9007		14,04	14,16	14,28	35,88
		094384	094391 *	094407	110695
<b>MZ</b> 11 Moss green RAL 6005	14,28	14,04	14,16	14,28	35,88
	075475	075482	075499	075505	075512
<b>MOT</b> 12 Gentian blue RAL 5010	14,28	14,04	14,16	14,28	35,88
	075420	075437	075444	075451	075468
<b>TZ</b> 13 Reseda green RAL 6011	14,28	14,04	14,16	14,28	35,88
	075727 *	075734	075741	075758	075765 *
Package in pcs	5	5	5	5	5
Package in pcs	150	150	150	150	150

\* Custom production



GALV. STEEL  
POLYESTER



## CORNER INNER

P-PRI

Nominal dimension	200	250	280	333	400
Price in €/pcs	With VAT	With VAT	With VAT	With VAT	With VAT
<b>TM</b> 1 Testa di Moro RAL 8028	14,28	14,04	14,16	14,28	35,88
	076281	076274	076298	076304	076311
<b>AN</b> 2 Anthracite RAL 7016	14,28	14,04	14,16	14,28	35,88
	075772	075789	075796	075802	075819
<b>IC</b> 3 Intense black RAL 9005	14,28	14,04	14,16	14,28	35,88
	075871	075888	075895	075901	075918
<b>OC</b> 4 Steel red RAL 3009	14,28	14,04	14,16	14,28	35,88
	076120	076137	076144	076168	076151
<b>MH</b> 5 Copper brown RAL 8004	14,28	14,04	14,16	14,28	35,88
	075925	075932	075949	075956	075963
<b>SB</b> 6 Grey white RAL 9002	14,28	14,04	14,16	14,28	35,88
	076229	076236	076243	076250	076267
<b>BH</b> 7 White aluminum RAL 9006	14,28	14,04	14,16	14,28	35,88
	075826	075833	075840	075857	075864
<b>PS</b> 8 Dusty grey RAL 7037	14,28	14,04	14,16	14,28	35,88
	076175	076199	076182	076205	076212
<b>MM</b> 9 Metallic copper RAL extra	14,28	14,04	14,16	14,28	35,88
	075970	075987	075994	076007	076014
<b>BHT – P.20</b> 10 Grey aluminum RAL 9007		14,04	14,16	14,28	35,88
		094414	094421 *	094438	110688
<b>MZ</b> 11 Moss green RAL 6005	14,28	14,04	14,16	14,28	35,88
	076076	076083	076090	076106	076113
<b>MOT</b> 12 Gentian blue RAL 5010	14,28	14,04	14,16	14,28	35,88
	076021 *	076038	076045	076052	076069
<b>TZ</b> 13 Reseda green RAL 6011	14,28	14,04	14,16	14,28	35,88
	076335 *	076328	076342	076359	076366 *
Package in pcs 	5	5	5	5	5
Package in pcs 	150	150	150	150	150



\* Custom production



# GALVANIZED STEEL POLYESTER

## END CAP

## P-PCL

Nominal dimension	200	250	280	333	400
Price in €/pcs	With VAT	With VAT	With VAT	With VAT	With VAT
<b>TM</b> 1 Testa di Moro RAL 8028	1,74	1,56	1,68	1,74	2,70
	003164	003171	003188	003195	003201
<b>AN</b> 2 Anthracite RAL 7016	1,74	1,56	1,68	1,74	2,70
	002662	002679	002686	002693	002709
<b>IC</b> 3 Intense black RAL 9005	1,74	1,56	1,68	1,74	2,70
	002761	002778	002785	002792	002808
<b>OC</b> 4 Steel red RAL 3009	1,74	1,56	1,68	1,74	2,70
	003010	003027	003034	003041	003058
<b>MH</b> 5 Copper brown RAL 8004	1,74	1,56	1,68	1,74	2,70
	002815	002822	002839	002846	002853
<b>SB</b> 6 Grey white RAL 9002	1,74	1,56	1,68	1,74	2,70
	003119	003126	003133	003140	003157
<b>BH</b> 7 White aluminum RAL 9006	1,74	1,56	1,68	1,74	2,70
	002716	002723	002730	002747	002754
<b>PS</b> 8 Dusty grey RAL 7037	1,74	1,56	1,68	1,74	2,70
	003065	003072	003089	003096	003102
<b>MM</b> 9 Metallic copper RAL extra	1,74	1,56	1,68	1,74	2,70
	002860	002877	002884	002891	002907
<b>BHT – P.20</b> 10 Grey aluminum RAL 9007		1,56	1,68	1,74	2,70
		094568	094575 *	094582	094599
<b>MZ</b> 11 Moss green RAL 6005	1,74	1,56	1,68	1,74	2,70
	002969	002976	002983	002990	003003
<b>MOT</b> 12 Gentian blue RAL 5010	1,74	1,56	1,68	1,74	2,70
	002914	002921	002938	002945	002952
<b>TZ</b> 13 Reseda green RAL 6011	1,74	1,56	1,68	1,74	2,70
	003218 *	003225	003232	003249	003256
<b>Package in pcs</b> 	6/60	6/60	6/60	6/60	4/40
<b>Package in pcs</b> 	1 440	1 440	1 440	1 440	960

\* Custom production



GALV. STEEL  
POLYESTER

## END CAP WITH RUBBER SEAL

P-PCLG

Nominal dimension	250	280	333
Price in €/pcs	With VAT	With VAT	With VAT
<b>TM</b> 1 Testa di Moro RAL 8028	<b>3,18</b> 004338	<b>3,48</b> 004345	<b>3,60</b> 004352
<b>AN</b> 2 Anthracite RAL 7016	<b>3,18</b> 004031	<b>3,48</b> 004048	<b>3,60</b> 004055
<b>IC</b> 3 Intense black RAL 9005	<b>3,18</b> 004093	<b>3,48</b> 004109	<b>3,60</b> 004116
<b>OC</b> 4 Steel red RAL 3009	<b>3,18</b> 004246	<b>3,48</b> 004253	<b>3,60</b> 004260
<b>MH</b> 5 Copper brown RAL 8004	<b>3,18</b> 004123	<b>3,48</b> 004130	<b>3,60</b> 004147
<b>SB</b> 6 Grey white RAL 9002	<b>3,18</b> 004307	<b>3,48</b> 004314	<b>3,60</b> 004321
<b>BH</b> 7 White aluminum RAL 9006	<b>3,18</b> 004062	<b>3,48</b> 004079	<b>3,60</b> 004086
<b>PS</b> 8 Dusty grey RAL 7037	<b>3,18</b> 004277	<b>3,48</b> 004284	<b>3,60</b> 004291
<b>MM</b> 9 Metallic copper RAL extra	<b>3,18</b> 004154	<b>3,48</b> 004161	<b>3,60</b> 004178
<b>BHT – P.20</b> 10 Grey aluminum RAL 9007	<b>3,18</b> 094605	<b>3,48</b> 094612 *	<b>3,60</b> 094629
<b>MZ</b> 11 Moss green RAL 6005	<b>3,18</b> 004215	<b>3,48</b> 004222	<b>3,60</b> 004239
<b>MOT</b> 12 Gentian blue RAL 5010	<b>3,18</b> 004185	<b>3,48</b> 004192	<b>3,60</b> 004208
<b>TZ</b> 13 Reseda green RAL 6011	<b>3,18</b> 004369 *	<b>3,48</b> 004376 *	<b>3,60</b> 004383 *
<b>Package in pcs</b> 	<b>4/40</b>	<b>4/40</b>	<b>4/40</b>
<b>Package in pcs</b> 	<b>960</b>	<b>960</b>	<b>960</b>

\* Custom production



# GALVANIZED STEEL POLYESTER

## OUTLET

## P-PKL

Nominal dimension	200/60	250/60	250/80	280/80	280/100
Price in €/pcs	With VAT	With VAT	With VAT	With VAT	With VAT
<b>TM</b> 1 Testa di Moro RAL 8028	8,88	10,80	7,92	8,64	8,64
	067357	067364	067371	067388	067395
<b>AN</b> 2 Anthracite RAL 7016	8,88	10,80	7,92	8,64	8,64
	066251	066268	066275	066282	066299
<b>IC</b> 3 Intense black RAL 9005	8,88	10,80	7,92	8,64	8,64
	066473	066480	066497	066503	066510
<b>OC</b> 4 Steel red RAL 3009	8,88	10,80	7,92	8,64	8,64
	067029	067036	067043	067050	067067
<b>MH</b> 5 Copper brown RAL 8004	8,88	10,80	7,92	8,64	8,64
	066589	066596	066602	066619	066626
<b>SB</b> 6 Grey white RAL 9002	8,88	10,80	7,92	8,64	8,64
	067241	067258	067265	067272	067289
<b>BH</b> 7 White aluminum RAL 9006	8,88	10,80	7,92	8,64	8,64
	066367	066374	066381	066398	066404
<b>PS</b> 8 Dusty grey RAL 7037	8,88	10,80	7,92	8,64	8,64
	067135	067142 *	067159	067166	067173
<b>MM</b> 9 Metallic copper RAL extra	8,88	10,80	7,92	8,64	8,64
	066695	066701 *	066718	066725	066732
<b>BHT – P.20</b> 10 Grey aluminum RAL 9007	8,88	10,80	7,92	8,64	8,64
	119728 *	119735 *	094469	094476	094483
<b>MZ</b> 11 Moss green RAL 6005	8,88	10,80	7,92	8,64	8,64
	066916	066923	066930	066947	066954
<b>MOT</b> 12 Gentian blue RAL 5010	8,88	10,80	7,92	8,64	8,64
	066800 *	066817 *	066824	066831	066848
<b>TZ</b> 13 Reseda green RAL 6011	8,88	10,80	7,92	8,64	8,64
	067463 *	067470 *	067487	067494 *	067500
Package in pcs 	20	20	20	20	20
Package in pcs 	600	600	600	600	600

\* Custom production



GALV. STEEL  
POLYESTER

# GALVANIZED STEEL POLYESTER

## OUTLET

## P-PKL



Nominal dimension	333/80	333/100	333/120
Price in €/pcs	With VAT	With VAT	With VAT
<b>TM</b> 1 Testa di Moro RAL 8028	<b>10,08</b> 067401	<b>9,54</b> 067418	<b>11,40</b> 067425
<b>AN</b> 2 Anthracite RAL 7016	<b>10,08</b> 066305	<b>9,54</b> 066312	<b>11,40</b> 066329
<b>IC</b> 3 Intense black RAL 9005	<b>10,08</b> 066527	<b>9,54</b> 066534	<b>11,40</b> 066541
<b>OC</b> 4 Steel red RAL 3009	<b>10,08</b> 067074	<b>9,54</b> 067081	<b>11,40</b> 067098
<b>MH</b> 5 Copper brown RAL 8004	<b>10,08</b> 066633	<b>9,54</b> 066640	<b>11,40</b> 066657
<b>SB</b> 6 Grey white RAL 9002	<b>10,08</b> 067296	<b>9,54</b> 067302	<b>11,40</b> 067326
<b>BH</b> 7 White aluminum RAL 9006	<b>10,08</b> 066411	<b>9,54</b> 066428	<b>11,40</b> 066435
<b>PS</b> 8 Dusty grey RAL 7037	<b>10,08</b> 067180	<b>9,54</b> 067197	<b>11,40</b> 067203
<b>MM</b> 9 Metallic copper RAL extra	<b>10,08</b> 066749	<b>9,54</b> 066756	<b>11,40</b> 066763
<b>BHT – P.20</b> 10 Grey aluminum RAL 9007	<b>10,08</b> 094490 *	<b>9,54</b> 094506	<b>11,40</b> 094513
<b>MZ</b> 11 Moss green RAL 6005	<b>10,08</b> 066961	<b>9,54</b> 066978	<b>11,40</b> 066985
<b>MOT</b> 12 Gentian blue RAL 5010	<b>10,08</b> 066855 *	<b>9,54</b> 066862	<b>11,40</b> 066879
<b>TZ</b> 13 Reseda green RAL 6011	<b>10,08</b> 067517 *	<b>9,54</b> 067524	<b>11,40</b> 067531
<b>Package in pcs</b>	<b>20</b>	<b>20</b>	<b>15</b>
<b>Package in pcs</b>	<b>600</b>	<b>600</b>	<b>300</b>

\* Custom production

# GALVANIZED STEEL POLYESTER

## OUTLET

## P-PKL

Nominal dimension	400/100	400/120	400/150
Price in €/pcs	With VAT	With VAT	With VAT
<b>TM</b> 1 Testa di Moro RAL 8028	<b>22,80</b> 067432	<b>22,80</b> 067449	<b>25,80</b> 067456
<b>AN</b> 2 Anthracite RAL 7016	<b>22,80</b> 066336	<b>22,80</b> 066343	<b>25,80</b> 066350
<b>IC</b> 3 Intense black RAL 9005	<b>22,80</b> 066558	<b>22,80</b> 066565	<b>25,80</b> 066572
<b>OC</b> 4 Steel red RAL 3009	<b>22,80</b> 067104 *	<b>22,80</b> 067111	<b>25,80</b> 067128
<b>MH</b> 5 Copper brown RAL 8004	<b>22,80</b> 066664 *	<b>22,80</b> 066671	<b>25,80</b> 066688
<b>SB</b> 6 Grey white RAL 9002	<b>22,80</b> 067319	<b>22,80</b> 067333	<b>25,80</b> 067340
<b>BH</b> 7 White aluminum RAL 9006	<b>22,80</b> 066442	<b>22,80</b> 066459	<b>25,80</b> 066466
<b>PS</b> 8 Dusty grey RAL 7037	<b>22,80</b> 067210	<b>22,80</b> 067227	<b>25,80</b> 067234
<b>MM</b> 9 Metallic copper RAL extra	<b>22,80</b> 066770 *	<b>22,80</b> 066787 *	<b>25,80</b> 066794 *
<b>BHT – P.20</b> 10 Grey aluminum RAL 9007	<b>22,80</b> 119742 *	<b>22,80</b> 094520	<b>25,80</b> 094667
<b>MZ</b> 11 Moss green RAL 6005	<b>22,80</b> 066992 *	<b>22,80</b> 067005	<b>25,80</b> 067012
<b>MOT</b> 12 Gentian blue RAL 5010	<b>22,80</b> 066886 *	<b>22,80</b> 066893	<b>25,80</b> 066909
<b>TZ</b> 13 Reseda green RAL 6011	<b>22,80</b> 067548 *	<b>22,80</b> 067555	<b>25,80</b> 067562 *
<b>Package in pcs</b> 	<b>15</b>	<b>15</b>	<b>15</b>
<b>Package in pcs</b> 	<b>300</b>	<b>300</b>	<b>300</b>

\* Custom production



GALV. STEEL  
POLYESTER

# GALVANIZED STEEL POLYESTER

NEW CLAMPING SYSTEM FEDER ENABLES TO TURN THE ELBOW EASY IN THE DESIRED DIRECTION AND HOLDS RELIABLY IN ANY POSITION. EASY INSTALLATION TO ANY ELBOW WITHOUT RIVETING.



# GALVANIZED STEEL POLYESTER

## GUTTER OUTLET NECK

P-PHRD

Nominal dimension	80	100	120
Price in €/pcs	With VAT	With VAT	With VAT
<b>TM</b> 1 Testa di Moro RAL 8028	<b>2,16</b> 066015	<b>2,28</b> 066022	<b>2,76</b> 066039
<b>AN</b> 2 Anthracite RAL 7016	<b>2,16</b> 065711	<b>2,28</b> 065728	<b>2,76</b> 065735 *
<b>IC</b> 3 Intense black RAL 9005	<b>2,16</b> 065773 *	<b>2,28</b> 065780	<b>2,76</b> 065797 *
<b>OC</b> 4 Steel red RAL 3009	<b>2,16</b> 065926 *	<b>2,28</b> 065933	<b>2,76</b> 065940 *
<b>MH</b> 5 Copper brown RAL 8004	<b>2,16</b> 065803 *	<b>2,28</b> 065810	<b>2,76</b> 065827 *
<b>SB</b> 6 Grey white RAL 9002	<b>2,16</b> 065988 *	<b>2,28</b> 065995 *	<b>2,76</b> 066008 *
<b>BH</b> 7 White aluminum RAL 9006	<b>2,16</b> 065742 *	<b>2,28</b> 065759 *	<b>2,76</b> 065766 *
<b>PS</b> 8 Dusty grey RAL 7037	<b>2,16</b> 065957 *	<b>2,28</b> 065964 *	<b>2,76</b> 065971 *
<b>MM</b> 9 Metallic copper RAL extra	<b>2,16</b> 065834 *	<b>2,28</b> 065841 *	<b>2,76</b> 065858 *
<b>BHT – P.20</b> 10 Grey aluminum RAL 9007			
<b>MZ</b> 11 Moss green RAL 6005	<b>2,16</b> 065896 *	<b>2,28</b> 065902 *	<b>2,76</b> 065919 *
<b>MOT</b> 12 Gentian blue RAL 5010	<b>2,16</b> 065865 *	<b>2,28</b> 065872 *	<b>2,76</b> 065889 *
<b>TZ</b> 13 Reseda green RAL 6011	<b>2,16</b> 066046 *	<b>2,28</b> 066053 *	<b>2,76</b> 066060 *
Package in pcs 	<b>25</b>	<b>25</b>	<b>15</b>
Package in pcs 	<b>1 000</b>	<b>1 000</b>	<b>750</b>

\* Custom production



GALV. STEEL  
POLYESTER





# GALVANIZED STEEL POLYESTER

## STAINLESS STEEL LEAF SIEVE

N-NZN



Nominal dimension	EAN product number	Packaging in pcs		Price with VAT [€/pcs]
				
60	001153	30	2 160	<b>6,66</b>
80	001160	20	1 440	<b>6,72</b>
100	001177	15	1 080	<b>6,84</b>
120	001184	10	720	<b>7,44</b>
150	001191	5	360	<b>11,76</b>



# GALVANIZED STEEL POLYESTER

## HOPPER DESIGN

P-PKLZ DE

Nominal dimension	80	100	120
Price in €/pcs	With VAT	With VAT	With VAT
<b>TM</b> 1 Testa di Moro RAL 8028	<b>69,60</b> 027702	<b>69,60</b> 027726	<b>76,80</b> 027740
<b>AN</b> 2 Anthracite RAL 7016	<b>69,60</b> 026200	<b>69,60</b> 026224	<b>76,80</b> 026248
<b>IC</b> 3 Intense black RAL 9005	<b>69,60</b> 026507	<b>69,60</b> 026521	<b>76,80</b> 026545
<b>OC</b> 4 Steel red RAL 3009	<b>69,60</b> 027252 *	<b>69,60</b> 027276	<b>76,80</b> 027290
<b>MH</b> 5 Copper brown RAL 8004	<b>69,60</b> 026651	<b>69,60</b> 026675	<b>76,80</b> 026699
<b>SB</b> 6 Grey white RAL 9002	<b>69,60</b> 027559 *	<b>69,60</b> 027573	<b>76,80</b> 027597
<b>BH</b> 7 White aluminum RAL 9006	<b>69,60</b> 026354	<b>69,60</b> 026378	<b>76,80</b> 026392
<b>PS</b> 8 Dusty grey RAL 7037	<b>69,60</b> 027405	<b>69,60</b> 027429	<b>76,80</b> 027443
<b>MM</b> 9 Metallic copper RAL extra	<b>69,60</b> 026804 *	<b>69,60</b> 026828	<b>76,80</b> 026842
<b>BHT – P.20</b> 10 Grey aluminum RAL 9007	<b>69,60</b> 096210	<b>69,60</b> 096265	<b>76,80</b> 096319
<b>MZ</b> 11 Moss green RAL 6005	<b>69,60</b> 027108 *	<b>69,60</b> 027122	<b>76,80</b> 027146 *
<b>MOT</b> 12 Gentian blue RAL 5010	<b>69,60</b> 026958 *	<b>69,60</b> 026972	<b>76,80</b> 027009 *
<b>TZ</b> 13 Reseda green RAL 6011	<b>69,60</b> 027856 *	<b>69,60</b> 027870 *	<b>76,80</b> 027894 *
<b>Package in pcs</b>	<b>2</b>	<b>2</b>	<b>2</b>
<b>Package in pcs</b>	<b>36</b>	<b>36</b>	<b>36</b>

\* Custom production



GALV. STEEL  
POLYESTER

# GALVANIZED STEEL POLYESTER

## HOPPER DESIGN ECCENTRIC

## P-PKLZ DX



Nominal dimension	80	100	120
Price in €/pcs	With VAT	With VAT	With VAT
<b>TM</b> 1 Testa di Moro RAL 8028	<b>86,40</b> 027764	<b>86,40</b> 027795	<b>88,80</b> 027825
<b>AN</b> 2 Anthracite RAL 7016	<b>86,40</b> 026262	<b>86,40</b> 026293	<b>88,80</b> 026323
<b>IC</b> 3 Intense black RAL 9005	<b>86,40</b> 026569	<b>86,40</b> 026590	<b>88,80</b> 026620 *
<b>OC</b> 4 Steel red RAL 3009	<b>86,40</b> 027313	<b>86,40</b> 027344	<b>88,80</b> 027375 *
<b>MH</b> 5 Copper brown RAL 8004	<b>86,40</b> 026712 *	<b>86,40</b> 026743 *	<b>88,80</b> 026774 *
<b>SB</b> 6 Grey white RAL 9002	<b>86,40</b> 027610 *	<b>86,40</b> 027641	<b>88,80</b> 027672
<b>BH</b> 7 White aluminum RAL 9006	<b>86,40</b> 026415 *	<b>86,40</b> 026446	<b>88,80</b> 026477
<b>PS</b> 8 Dusty grey RAL 7037	<b>86,40</b> 027467 *	<b>86,40</b> 027498	<b>88,80</b> 027528
<b>MM</b> 9 Metallic copper RAL extra	<b>86,40</b> 026866 *	<b>86,40</b> 026897	<b>88,80</b> 026927 *
<b>BHT – P.20</b> 10 Grey aluminum RAL 9007	<b>86,40</b> 096203 *	<b>86,40</b> 096258	<b>88,80</b> 096302
<b>MZ</b> 11 Moss green RAL 6005	<b>86,40</b> 027160 *	<b>86,40</b> 027191 *	<b>88,80</b> 027221 *
<b>MOT</b> 12 Gentian blue RAL 5010	<b>86,40</b> 027016 *	<b>86,40</b> 027047 *	<b>88,80</b> 027078 *
<b>TZ</b> 13 Reseda green RAL 6011	<b>86,40</b> 027917 *	<b>86,40</b> 027948 *	<b>88,80</b> 027979 *
<b>Package in pcs</b> 	<b>2</b>	<b>2</b>	<b>2</b>
<b>Package in pcs</b> 	<b>36</b>	<b>36</b>	<b>36</b>



\* Custom production

# GALVANIZED STEEL POLYESTER

## HOPPER CUBIC

## P-PKLZ KU



Nominal dimension	80	100	120
Price in €/pcs	With VAT	With VAT	With VAT
<b>TM</b> 1 Testa di Moro RAL 8028	<b>105,60</b> 027719 *	<b>105,60</b> 027733	<b>112,80</b> 027757
<b>AN</b> 2 Anthracite RAL 7016	<b>105,60</b> 026217	<b>105,60</b> 026231	<b>112,80</b> 026255
<b>IC</b> 3 Intense black RAL 9005	<b>105,60</b> 026514	<b>105,60</b> 026538	<b>112,80</b> 026552
<b>OC</b> 4 Steel red RAL 3009	<b>105,60</b> 027269 *	<b>105,60</b> 027283 *	<b>112,80</b> 027306
<b>MH</b> 5 Copper brown RAL 8004	<b>105,60</b> 026668 *	<b>105,60</b> 026682 *	<b>112,80</b> 026705 *
<b>SB</b> 6 Grey white RAL 9002	<b>105,60</b> 027566 *	<b>105,60</b> 027580 *	<b>112,80</b> 027603 *
<b>BH</b> 7 White aluminum RAL 9006	<b>105,60</b> 026361 *	<b>105,60</b> 026385	<b>112,80</b> 026408
<b>PS</b> 8 Dusty grey RAL 7037	<b>105,60</b> 027412 *	<b>105,60</b> 027436 *	<b>112,80</b> 027450
<b>MM</b> 9 Metallic copper RAL extra	<b>105,60</b> 026811 *	<b>105,60</b> 026835 *	<b>112,80</b> 026859 *
<b>BHT – P.20</b> 10 Grey aluminum RAL 9007	<b>105,60</b> 096241 *	<b>105,60</b> 096296 *	<b>112,80</b> 096340 *
<b>MZ</b> 11 Moss green RAL 6005	<b>105,60</b> 027115 *	<b>105,60</b> 027139 *	<b>112,80</b> 027153 *
<b>MOT</b> 12 Gentian blue RAL 5010	<b>105,60</b> 026965 *	<b>105,60</b> 026989 *	<b>112,80</b> 026996 *
<b>TZ</b> 13 Reseda green RAL 6011	<b>105,60</b> 027863 *	<b>105,60</b> 027887 *	<b>112,80</b> 027900 *
<b>Package in pcs</b> 	<b>2</b>	<b>2</b>	<b>2</b>
<b>Package in pcs</b> 	<b>36</b>	<b>36</b>	<b>36</b>

\* Custom production

# GALVANIZED STEEL POLYESTER

## HOPPER CUBIC ECCENTRIC

## P-PKLZ KX



Nominal dimension	80	100	120
Price in €/pcs	With VAT	With VAT	With VAT
<b>TM</b> 1 Testa di Moro RAL 8028	<b>105,60</b> 027788	<b>105,60</b> 027818	<b>112,80</b> 027849
<b>AN</b> 2 Anthracite RAL 7016	<b>105,60</b> 026286	<b>105,60</b> 026316	<b>112,80</b> 026347
<b>IC</b> 3 Intense black RAL 9005	<b>105,60</b> 026583	<b>105,60</b> 026613	<b>112,80</b> 026644 *
<b>OC</b> 4 Steel red RAL 3009	<b>105,60</b> 027337 *	<b>105,60</b> 027368	<b>112,80</b> 027399
<b>MH</b> 5 Copper brown RAL 8004	<b>105,60</b> 026736	<b>105,60</b> 026767	<b>112,80</b> 026798 *
<b>SB</b> 6 Grey white RAL 9002	<b>105,60</b> 027634 *	<b>105,60</b> 027665	<b>112,80</b> 027696
<b>BH</b> 7 White aluminum RAL 9006	<b>105,60</b> 026439 *	<b>105,60</b> 026460	<b>112,80</b> 026491
<b>PS</b> 8 Dusty grey RAL 7037	<b>105,60</b> 027481 *	<b>105,60</b> 027511	<b>112,80</b> 027542
<b>MM</b> 9 Metallic copper RAL extra	<b>105,60</b> 026880 *	<b>105,60</b> 026910	<b>112,80</b> 026941 *
<b>BHT – P.20</b> 10 Grey aluminum RAL 9007	<b>105,60</b> 096227	<b>105,60</b> 096272	<b>112,80</b> 096326
<b>MZ</b> 11 Moss green RAL 6005	<b>105,60</b> 027184 *	<b>105,60</b> 027214	<b>112,80</b> 027245 *
<b>MOT</b> 12 Gentian blue RAL 5010	<b>105,60</b> 027030 *	<b>105,60</b> 027061 *	<b>112,80</b> 027092 *
<b>TZ</b> 13 Reseda green RAL 6011	<b>105,60</b> 027931 *	<b>105,60</b> 027962	<b>112,80</b> 027993 *
<b>Package in pcs</b> 	<b>2</b>	<b>2</b>	<b>2</b>
<b>Package in pcs</b> 	<b>36</b>	<b>36</b>	<b>36</b>

\* Custom production

# GALVANIZED STEEL POLYESTER

## HOPPER CUBIC ECCENTRIC WITH OVERFLOW PIPE

## P-PKLZ KXV





Nominal dimension	80	100	120
Price in €/pcs	With VAT	With VAT	With VAT
<b>TM</b> 1 Testa di Moro RAL 8028	<b>138,00</b> 027771 *	<b>138,00</b> 027801 *	<b>138,00</b> 027832 *
<b>AN</b> 2 Anthracite RAL 7016	<b>138,00</b> 026279 *	<b>138,00</b> 026309 *	<b>138,00</b> 026330 *
<b>IC</b> 3 Intense black RAL 9005	<b>138,00</b> 026576 *	<b>138,00</b> 026606	<b>138,00</b> 026637 *
<b>OC</b> 4 Steel red RAL 3009	<b>138,00</b> 027320 *	<b>138,00</b> 027351 *	<b>138,00</b> 027382 *
<b>MH</b> 5 Copper brown RAL 8004	<b>138,00</b> 026729 *	<b>138,00</b> 026750 *	<b>138,00</b> 026781 *
<b>SB</b> 6 Grey white RAL 9002	<b>138,00</b> 027627 *	<b>138,00</b> 027658 *	<b>138,00</b> 027689 *
<b>BH</b> 7 White aluminum RAL 9006	<b>138,00</b> 026422 *	<b>138,00</b> 026453 *	<b>138,00</b> 026484 *
<b>PS</b> 8 Dusty grey RAL 7037	<b>138,00</b> 027474 *	<b>138,00</b> 027504 *	<b>138,00</b> 027535 *
<b>MM</b> 9 Metallic copper RAL extra	<b>138,00</b> 026873 *	<b>138,00</b> 026903 *	<b>138,00</b> 026934 *
<b>BHT – P.20</b> 10 Grey aluminum RAL 9007	<b>138,00</b> 096234 *	<b>138,00</b> 096289 *	<b>138,00</b> 096333 *
<b>MZ</b> 11 Moss green RAL 6005	<b>138,00</b> 027177 *	<b>138,00</b> 027207 *	<b>138,00</b> 027238 *
<b>MOT</b> 12 Gentian blue RAL 5010	<b>138,00</b> 027023 *	<b>138,00</b> 027054 *	<b>138,00</b> 027085 *
<b>TZ</b> 13 Reseda green RAL 6011	<b>138,00</b> 027924 *	<b>138,00</b> 027955 *	<b>138,00</b> 027986 *
<b>Package in pcs</b> 	<b>2</b>	<b>2</b>	<b>2</b>
<b>Package in pcs</b> 	<b>36</b>	<b>36</b>	<b>36</b>

\* Custom production

## RUBBER SEAL FOR HOPPER

P-PKLZ T



Nominal dimension	EAN product number	Packaging in pcs		Price with VAT [€/pcs]
				
<b>IC 70-85</b>	077103	5	600	<b>4,80</b>
<b>IC 100-110</b>	077110	5	600	<b>4,92</b>
<b>IC 110-125</b>	077097	5	600	<b>5,04</b>
<b>PS 70-85</b>	077134	5	600	<b>5,40</b>
<b>PS 100-110</b>	077141	5	600	<b>5,88</b>
<b>PS 110-125</b>	077127	5	600	<b>6,00</b>

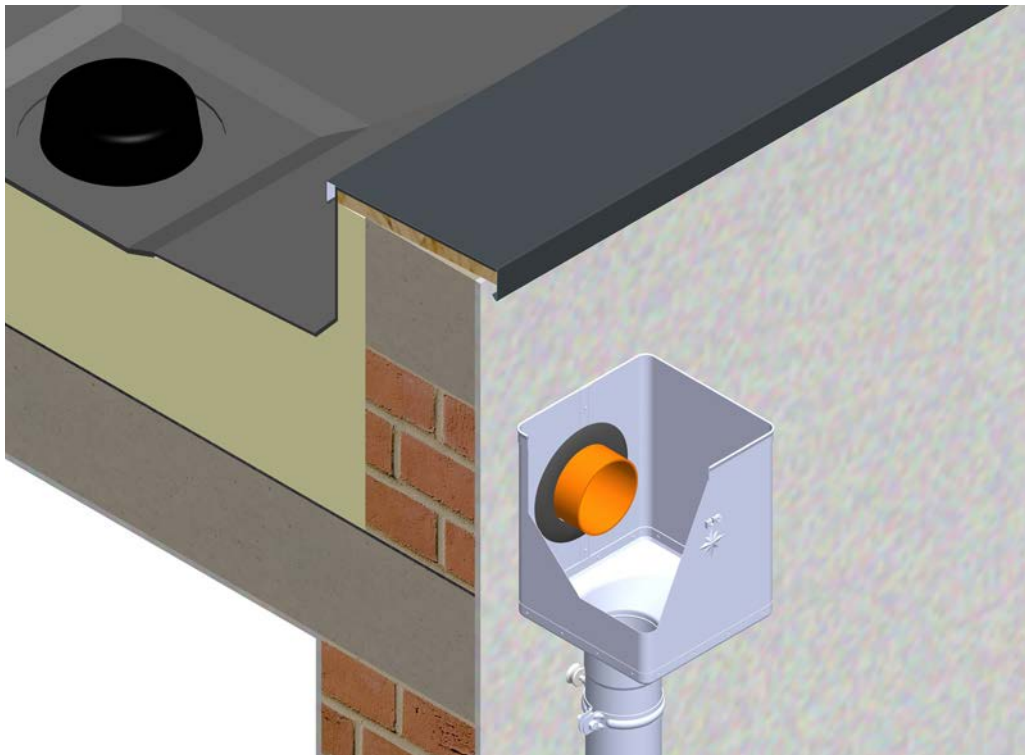

# GALVANIZED STEEL POLYESTER

## ELBOW FOLDED 72°

P-PK

Nominal dimension	60	80	100	120	150
Price in €/pcs	With VAT	With VAT	With VAT	With VAT	With VAT
<b>TM</b> 1 Testa di Moro RAL 8028	7,20	6,60	7,20	10,20	23,94
	072542	072559	072573	072597	033697
<b>AN</b> 2 Anthracite RAL 7016	7,20	6,60	7,20	10,20	23,94
	071842	071859	071873	071897	033598
<b>IC</b> 3 Intense black RAL 9005	7,20	6,60	7,20	10,20	23,94
	071989	072023	072009	072030	033611
<b>OC</b> 4 Steel red RAL 3009	7,20	6,60	7,20	10,20	23,94
	072337	072344	072368	072382	033666
<b>MH</b> 5 Copper brown RAL 8004	7,20	6,60	7,20	10,20	23,94
	072054	072061	072085	072108	033628
<b>SB</b> 6 Grey white RAL 9002	7,20	6,60	7,20	10,20	23,94
	072474	072481	072504	072528	033680
<b>BH</b> 7 White aluminum RAL 9006	7,20	6,60	7,20	10,20	23,94
	071910	071927	071941	071965	033604
<b>PS</b> 8 Dusty grey RAL 7037	7,20	6,60	7,20	10,20	23,94
	072405	072412	072429	072443	033673
<b>MM</b> 9 Metallic copper RAL extra	7,20	6,60	7,20	10,20	23,94
	072122	072139	072153	072160	033635
<b>BHT – P.20</b> 10 Grey aluminum RAL 9007	7,20	6,60	7,20	10,20	23,94
	118691 *	095183	095206	095220	095244
<b>MZ</b> 11 Moss green RAL 6005	7,20	6,60	7,20	10,20	23,94
	072269	072276	072290	072313	033659
<b>MOT</b> 12 Gentian blue RAL 5010	7,20	6,60	7,20	10,20	23,94
	072191	072207	072221	072245	033642
<b>TZ</b> 13 Reseda green RAL 6011	7,20	6,60	7,20	10,20	23,94
	072610 *	072627	072641	072665	033703 *
Package in pcs	25	25	25	15	5
Package in pcs	600	400	300	180	90

\* Custom production



GALV. STEEL  
POLYESTER



# GALVANIZED STEEL POLYESTER

## ELBOW FOLDED 85°

P-PKR

Nominal dimension	80	100	120
Price in €/pcs	With VAT	With VAT	With VAT
<b>TM</b> 1 Testa di Moro RAL 8028	<b>8,28</b> 072566	<b>9,36</b> 072580	<b>14,88</b> 072603
<b>AN</b> 2 Anthracite RAL 7016	<b>8,28</b> 071866	<b>9,36</b> 071880	<b>14,88</b> 071903
<b>IC</b> 3 Intense black RAL 9005	<b>8,28</b> 071996	<b>9,36</b> 072016	<b>14,88</b> 072047
<b>OC</b> 4 Steel red RAL 3009	<b>8,28</b> 072351	<b>9,36</b> 072375	<b>14,88</b> 072399
<b>MH</b> 5 Copper brown RAL 8004	<b>8,28</b> 072078	<b>9,36</b> 072092	<b>14,88</b> 072115
<b>SB</b> 6 Grey white RAL 9002	<b>8,28</b> 072498	<b>9,36</b> 072511	<b>14,88</b> 072535
<b>BH</b> 7 White aluminum RAL 9006	<b>8,28</b> 071934	<b>9,36</b> 071958	<b>14,88</b> 071972
<b>PS</b> 8 Dusty grey RAL 7037	<b>8,28</b> 072467	<b>9,36</b> 072436	<b>14,88</b> 072450
<b>MM</b> 9 Metallic copper RAL extra	<b>8,28</b> 072146	<b>9,36</b> 072184	<b>14,88</b> 072177
<b>BHT – P.20</b> 10 Grey aluminum RAL 9007	<b>8,28</b> 095190	<b>9,36</b> 095213	<b>14,88</b> 095237 *
<b>MZ</b> 11 Moss green RAL 6005	<b>8,28</b> 072283	<b>9,36</b> 072306	<b>14,88</b> 072320
<b>MOT</b> 12 Gentian blue RAL 5010	<b>8,28</b> 072214 *	<b>9,36</b> 072238 *	<b>14,88</b> 072252 *
<b>TZ</b> 13 Reseda green RAL 6011	<b>8,28</b> 072634 *	<b>9,36</b> 072658 *	<b>14,88</b> 072672 *
<b>Package in pcs</b> 📦	<b>25</b>	<b>25</b>	<b>15</b>
<b>Package in pcs</b> 🚚	<b>400</b>	<b>300</b>	<b>180</b>

\* Custom production



# GALVANIZED STEEL POLYESTER

## ELBOW BLIND 40°

P-PKT

Nominal dimension	80	100	120
Price in €/pcs	With VAT	With VAT	With VAT
<b>TM</b> 1 Testa di Moro RAL 8028	<b>7,80</b> 072993	<b>8,52</b> 073006	<b>12,00</b> 073013
<b>AN</b> 2 Anthracite RAL 7016	<b>7,80</b> 072696	<b>8,52</b> 072702	<b>12,00</b> 072719
<b>IC</b> 3 Intense black RAL 9005	<b>7,80</b> 072757	<b>8,52</b> 072764	<b>12,00</b> 072771
<b>OC</b> 4 Steel red RAL 3009	<b>7,80</b> 072900	<b>8,52</b> 072917	<b>12,00</b> 072924
<b>MH</b> 5 Copper brown RAL 8004	<b>7,80</b> 072795	<b>8,52</b> 072788	<b>12,00</b> 072801
<b>SB</b> 6 Grey white RAL 9002	<b>7,80</b> 072962	<b>8,52</b> 072979	<b>12,00</b> 072986
<b>BH</b> 7 White aluminum RAL 9006	<b>7,80</b> 072726	<b>8,52</b> 072733	<b>12,00</b> 072740
<b>PS</b> 8 Dusty grey RAL 7037	<b>7,80</b> 072931	<b>8,52</b> 072948	<b>12,00</b> 072955
<b>MM</b> 9 Metallic copper RAL extra	<b>7,80</b> 072818	<b>8,52</b> 072825	<b>12,00</b> 072832 *
<b>BHT – P.20</b> 10 Grey aluminum RAL 9007	<b>7,80</b> 094711	<b>8,52</b> 094728	<b>12,00</b> 094735
<b>MZ</b> 11 Moss green RAL 6005	<b>7,80</b> 072870 *	<b>8,52</b> 072887	<b>12,00</b> 072894
<b>MOT</b> 12 Gentian blue RAL 5010	<b>7,80</b> 072849	<b>8,52</b> 072856	<b>12,00</b> 072863
<b>TZ</b> 13 Reseda green RAL 6011	<b>7,80</b> 073020 *	<b>8,52</b> 073037 *	<b>12,00</b> 073044 *
<b>Package in pcs</b>	<b>25</b>	<b>25</b>	<b>15</b>
<b>Package in pcs</b>	<b>400</b>	<b>300</b>	<b>240</b>

\* Custom production

GALV. STEEL  
POLYESTER



# GALVANIZED STEEL POLYESTER

## DOWNPOUT ELBOW 72°

P-PKV



Nominal dimension	80	100	120
Price in €/pcs	With VAT	With VAT	With VAT
<b>TM</b> 1 Testa di Moro RAL 8028	<b>7,80</b> 095046	<b>8,40</b> 095053	<b>11,40</b> 095060
<b>AN</b> 2 Anthracite RAL 7016	<b>7,80</b> 094742	<b>8,40</b> 094759	<b>11,40</b> 094766
<b>IC</b> 3 Intense black RAL 9005	<b>7,80</b> 094803	<b>8,40</b> 094810	<b>11,40</b> 094827 *
<b>OC</b> 4 Steel red RAL 3009	<b>7,80</b> 094957 *	<b>8,40</b> 094964	<b>11,40</b> 094971 *
<b>MH</b> 5 Copper brown RAL 8004	<b>7,80</b> 094834	<b>8,40</b> 094841	<b>11,40</b> 094858
<b>SB</b> 6 Grey white RAL 9002	<b>7,80</b> 095015 *	<b>8,40</b> 095022	<b>11,40</b> 095039
<b>BH</b> 7 White aluminum RAL 9006	<b>7,80</b> 094773 *	<b>8,40</b> 094780	<b>11,40</b> 094797
<b>PS</b> 8 Dusty grey RAL 7037	<b>7,80</b> 094988 *	<b>8,40</b> 094995 *	<b>11,40</b> 095008 *
<b>MM</b> 9 Metallic copper RAL extra	<b>7,80</b> 094865 *	<b>8,40</b> 094872 *	<b>11,40</b> 094889 *
<b>BHT – P.20</b> 10 Grey aluminum RAL 9007	<b>7,80</b> 124739 *	<b>8,40</b> 124746 *	<b>11,40</b> 124753 *
<b>MZ</b> 11 Moss green RAL 6005	<b>7,80</b> 094926 *	<b>8,40</b> 094933 *	<b>11,40</b> 094940 *
<b>MOT</b> 12 Gentian blue RAL 5010	<b>7,80</b> 094896 *	<b>8,40</b> 094902 *	<b>11,40</b> 094919 *
<b>TZ</b> 13 Reseda green RAL 6011	<b>7,80</b> 095077 *	<b>8,40</b> 095084 *	<b>11,40</b> 095091 *
<b>Package in pcs</b> 📦	<b>25</b>	<b>25</b>	<b>15</b>
<b>Package in pcs</b> 🚚	<b>400</b>	<b>300</b>	<b>180</b>

\* Custom production

GALV. STEEL  
POLYESTER

# GALVANIZED STEEL POLYESTER

## ELBOW FOLDED 72°

P-PKF2



Nominal dimension	60	80	100	120
Price in €/pcs	With VAT	With VAT	With VAT	With VAT
<b>TM</b> 1 Testa di Moro RAL 8028	<b>5,16</b>	<b>4,08</b>	<b>5,28</b>	<b>7,56</b>
	071781	071798	071811	071828
Package in pcs	10	10	10	8
Package in pcs	3 000	1 200	800	576

## ELBOW FOLDED 85°

P-PKF3



Nominal dimension	80	100
Price in €/pcs	With VAT	With VAT
<b>TM</b> 1 Testa di Moro RAL 8028	<b>5,28</b>	<b>7,56</b>
	071804	071835
Package in pcs	10	10
Package in pcs	1 200	800

## PLASTIC DOWNPIPE SLEEVE

SD-ZR FOLIA KJG



Nominal dimension	Lenght in m	EAN product number	Packaging in m		Cena with VAT [€/m]
<b>60-150</b>	100,0	139726	100	6 000	<b>0,46</b>

# GALVANIZED STEEL POLYESTER

## DOWNPIPE [s=0,55]

P-PZR



Nominal dimension	60	60	80	80	80
Length in m	2,0	3,0	1,0	2,0	3,0
Price in €/m	With VAT	With VAT	With VAT	With VAT	With VAT
<b>TM</b> 1 Testa di Moro RAL 8028	<b>9,60</b>	<b>9,60</b>	<b>8,64</b>	<b>8,64</b>	<b>8,40</b>
	071309	071316	071323	071330	071347
<b>AN</b> 2 Anthracite RAL 7016	<b>9,60</b>	<b>9,60</b>	<b>8,64</b>	<b>8,64</b>	<b>8,40</b>
	069467	069474	069481	069498	069504
<b>IC</b> 3 Intense black RAL 9005	<b>9,60</b>	<b>9,60</b>	<b>8,64</b>	<b>8,64</b>	<b>8,40</b>
	069900	069917	069924	069931	069948
<b>OC</b> 4 Steel red RAL 3009	<b>9,60</b>	<b>9,60</b>	<b>8,64</b>	<b>8,64</b>	<b>8,40</b>
	070661	070678	070685	070692	070708
<b>MH</b> 5 Copper brown RAL 8004	<b>9,72</b>		<b>8,76</b>	<b>8,76</b>	<b>8,52</b>
	070128		070142	070159	070166
<b>SB</b> 6 Grey white RAL 9002	<b>9,72</b>	<b>9,72</b>	<b>8,76</b>	<b>8,76</b>	<b>8,52</b>
	071088	071095	071101	071118	071125
<b>BH</b> 7 White aluminum RAL 9006	<b>9,72</b>	<b>9,72</b>	<b>8,76</b>	<b>8,76</b>	<b>8,52</b>
	069689	069696	069702	069719	069726
<b>PS</b> 8 Dusty grey RAL 7037	<b>9,72</b>	<b>9,72</b>	<b>8,76</b>	<b>8,76</b>	<b>8,52</b>
	070883	070890	070906	070913	070920
<b>MM</b> 9 Metallic copper RAL extra	<b>10,20</b>		<b>9,30</b>	<b>9,30</b>	<b>9,06</b>
	070340		070364	070371	070388
<b>BHT – P.20</b> 10 Grey aluminum RAL 9007					<b>10,26</b>
					096128
<b>MZ</b> 11 Moss green RAL 6005	<b>10,20</b>				<b>9,06</b>
	070586				070593
<b>MOT</b> 12 Gentian blue RAL 5010	<b>10,20</b>				<b>9,06</b>
	070494				070500
<b>TZ</b> 13 Reseda green RAL 6011	<b>10,20</b>			<b>9,30</b>	
	071521 *			071538	
<b>Package in m</b>	<b>10</b>	<b>15</b>	<b>10</b>	<b>10</b>	<b>15</b>
<b>Package in m</b>	<b>490</b>	<b>735</b>	<b>100</b>	<b>250</b>	<b>375</b>

\* Custom production

# GALVANIZED STEEL POLYESTER

## DOWNPIPE [s=0,55]

P-PZR

Nominal dimension	80	80	80	100	100
Length in m	4,0	5,0	6,0	1,0	2,0
Price in €/m	With VAT	With VAT	With VAT	With VAT	With VAT
<b>TM</b> 1 Testa di Moro RAL 8028	<b>8,40</b>	<b>8,40</b>	<b>8,40</b>	<b>8,88</b>	<b>8,88</b>
	071354	071361 *	071378 *	071385	071392
<b>AN</b> 2 Anthracite RAL 7016	<b>8,40</b>	<b>8,40</b>	<b>8,40</b>	<b>8,88</b>	<b>8,88</b>
	069511	069528 *	069535 *	069542	069559
<b>IC</b> 3 Intense black RAL 9005	<b>8,40</b>	<b>8,40</b>	<b>8,40</b>	<b>8,88</b>	<b>8,88</b>
	069955	069962 *	069979 *	069986	069993
<b>OC</b> 4 Steel red RAL 3009	<b>8,40</b>	<b>8,40</b>	<b>8,40</b>	<b>8,88</b>	<b>8,88</b>
	070715	070722 *	070739 *	070746	070753
<b>MH</b> 5 Copper brown RAL 8004	<b>8,52</b>	<b>8,52</b>	<b>8,52</b>	<b>9,00</b>	<b>9,00</b>
	070173	070180 *	070197 *	070203	070210
<b>SB</b> 6 Grey white RAL 9002	<b>8,52</b>	<b>8,52</b>	<b>8,52</b>	<b>9,00</b>	<b>9,00</b>
	071132	071149 *	071156 *	071163	071170
<b>BH</b> 7 White aluminum RAL 9006	<b>8,52</b>	<b>8,52</b>	<b>8,52</b>	<b>9,00</b>	<b>9,00</b>
	069733	069740 *	069757 *	069764	069771
<b>PS</b> 8 Dusty grey RAL 7037	<b>8,52</b>	<b>8,52</b>	<b>8,52</b>	<b>9,00</b>	<b>9,00</b>
	070937	070944 *	070951 *	070968	070975
<b>MM</b> 9 Metallic copper RAL extra	<b>9,06</b>		<b>10,08</b>	<b>10,08</b>	<b>11,16</b>
	070395		070401	070418	070418
<b>BHT – P.20</b> 10 Grey aluminum RAL 9007					
<b>MZ</b> 11 Moss green RAL 6005	<b>9,06</b>				
	070609				
<b>MOT</b> 12 Gentian blue RAL 5010					
<b>TZ</b> 13 Reseda green RAL 6011					
<b>Package in m</b> 	<b>20</b>	<b>5</b>	<b>6</b>	<b>10</b>	<b>10</b>
<b>Package in m</b> 	<b>500</b>	<b>625</b>	<b>750</b>	<b>70</b>	<b>160</b>

\* Custom production

GALV. STEEL  
POLYESTER



# GALVANIZED STEEL POLYESTER

## DOWNPIPE [s=0,55]

P-PZR





Nominal dimension	100	100	100	100	120
Length in m	3,0	4,0	5,0	6,0	1,0
Price in €/m	With VAT	With VAT	With VAT	With VAT	With VAT
<b>TM</b> 1 Testa di Moro RAL 8028	<b>8,64</b>	<b>8,64</b>	<b>8,64</b>	<b>8,64</b>	<b>12,90</b>
	071408	071415	071422	071439 *	071446
<b>AN</b> 2 Anthracite RAL 7016	<b>8,64</b>	<b>8,64</b>	<b>8,64</b>	<b>8,64</b>	<b>12,90</b>
	069566	069573	069580	069597 *	069603
<b>IC</b> 3 Intense black RAL 9005	<b>8,64</b>	<b>8,64</b>	<b>8,64</b>	<b>8,64</b>	<b>12,90</b>
	070005	070012	070029	070036 *	070043
<b>OC</b> 4 Steel red RAL 3009	<b>8,64</b>	<b>8,64</b>	<b>8,64</b>	<b>8,64</b>	<b>12,90</b>
	070760	070777	070784 *	070791 *	070807
<b>MH</b> 5 Copper brown RAL 8004	<b>8,76</b>	<b>8,76</b>	<b>8,76</b>	<b>8,76</b>	<b>13,02</b>
	070227	070234	070241 *	070258 *	070265
<b>SB</b> 6 Grey white RAL 9002	<b>8,76</b>	<b>8,76</b>	<b>8,76</b>	<b>8,76</b>	<b>13,02</b>
	071187	071194	071200 *	071217 *	071224
<b>BH</b> 7 White aluminum RAL 9006	<b>8,76</b>	<b>8,76</b>	<b>8,76</b>	<b>8,76</b>	<b>13,02</b>
	069788	069795	069801 *	069818 *	069825
<b>PS</b> 8 Dusty grey RAL 7037	<b>8,76</b>	<b>8,76</b>	<b>8,76</b>	<b>8,76</b>	<b>13,02</b>
	070982	070999	071002 *	071019 *	071026
<b>MM</b> 9 Metallic copper RAL extra	<b>9,84</b>	<b>9,84</b>			<b>13,80</b>
	070425	070432			070449
<b>BHT – P.20</b> 10 Grey aluminum RAL 9007	<b>10,56</b>	<b>10,56</b>			
	096135	096142			
<b>MZ</b> 11 Moss green RAL 6005	<b>9,84</b>	<b>9,84</b>			
	070616	070623			
<b>MOT</b> 12 Gentian blue RAL 5010	<b>9,84</b>	<b>9,84</b>			
	070524	070531			
<b>TZ</b> 13 Reseda green RAL 6011	<b>9,84</b>	<b>9,84</b>			
	071545	071552			
Package in m	15	20	5	6	8
Package in m	240	320	400	480	48

\* Custom production

# GALVANIZED STEEL POLYESTER

## DOWNPIPE [s=0,55]

P-PZR

Nominal dimension	120	120	120	120	120
Length in m	2,0	3,0	4,0	5,0	6,0
Price in €/m	With VAT	With VAT	With VAT	With VAT	With VAT
<b>TM</b> 1 Testa di Moro RAL 8028	<b>12,90</b>	<b>12,66</b>	<b>12,66</b>	<b>12,66</b>	<b>12,66</b>
	071453	071460	071477	071484 *	071491 *
<b>AN</b> 2 Anthracite RAL 7016	<b>12,90</b>	<b>12,66</b>	<b>12,66</b>	<b>12,66</b>	<b>12,66</b>
	069610	069627	069634	069641 *	069658 *
<b>IC</b> 3 Intense black RAL 9005	<b>12,90</b>	<b>12,66</b>	<b>12,66</b>	<b>12,66</b>	<b>12,66</b>
	070050	070067	070074	070081 *	070098 *
<b>OC</b> 4 Steel red RAL 3009	<b>12,90</b>	<b>12,66</b>	<b>12,66</b>	<b>12,66</b>	<b>12,66</b>
	070814	070821	070838	070845 *	070852 *
<b>MH</b> 5 Copper brown RAL 8004	<b>13,02</b>	<b>12,78</b>	<b>12,78</b>	<b>12,78</b>	<b>12,78</b>
	070272	070289	070296	070302 *	070319 *
<b>SB</b> 6 Grey white RAL 9002	<b>13,02</b>	<b>12,78</b>	<b>12,78</b>	<b>12,78</b>	<b>12,78</b>
	071231	071248	071255	071262	071279 *
<b>BH</b> 7 White aluminum RAL 9006	<b>13,02</b>	<b>12,78</b>	<b>12,78</b>	<b>12,78</b>	<b>12,78</b>
	069832	069849	069856	069863	069870 *
<b>PS</b> 8 Dusty grey RAL 7037	<b>13,02</b>	<b>12,78</b>	<b>12,78</b>		
	071033	071040	071057		
<b>MM</b> 9 Metallic copper RAL extra	<b>13,80</b>	<b>13,62</b>	<b>13,62</b>		
	070456	070463	070470		
<b>BHT – P.20</b> 10 Grey aluminum RAL 9007		<b>14,46</b>			
		096159			
<b>MZ</b> 11 Moss green RAL 6005		<b>13,62</b>	<b>13,62</b>		
		070630	070647		
<b>MOT</b> 12 Gentian blue RAL 5010		<b>13,62</b>	<b>13,62</b>		
		070548	070555		
<b>TZ</b> 13 Reseda green RAL 6011		<b>13,62</b>	<b>13,62</b>		
		071569	071576		
Package in m 	10	15	20	5	6
Package in m 	120	180	240	300	360

\* Custom production





# GALVANIZED STEEL POLYESTER

## DOWNPIPE [s=0,55]

P-PZR



Nominal dimension	150	150
Length in m	3,0	4,0
Price in €/m	With VAT	With VAT
<b>TM</b> Testa di Moro RAL 8028	<b>24,72</b> 071507	<b>24,72</b> 071514
<b>AN</b> Anthracite RAL 7016	<b>24,72</b> 069665	<b>24,72</b> 069672
<b>IC</b> Intense black RAL 9005		<b>24,72</b> 070111
<b>OC</b> Steel red RAL 3009		<b>24,72</b> 070876
<b>MH</b> Copper brown RAL 8004	<b>24,84</b> 070326	
<b>SB</b> Grey white RAL 9002	<b>24,84</b> 071286	<b>24,84</b> 071293
<b>BH</b> White aluminum RAL 9006	<b>24,84</b> 069887	<b>24,84</b> 069894
<b>PS</b> Dusty grey RAL 7037	<b>24,84</b> 071064	<b>24,84</b> 071071
<b>MM</b> Metallic copper RAL extra	<b>26,16</b> 070487	
<b>BHT – P.20</b> Grey aluminum RAL 9007	<b>26,70</b> 096166	
<b>MZ</b> Moss green RAL 6005	<b>26,16</b> 070654	
<b>MOT</b> Gentian blue RAL 5010		<b>26,16</b> 070579
<b>TZ</b> Reseda green RAL 6011	<b>26,16</b> 071583 *	
<b>Package in m</b>	<b>3</b>	<b>4</b>
<b>Package in m</b>	<b>84</b>	<b>112</b>

\* Custom production

## DOWNPIPE CONNECTOR

P-PSRU

Nominal dimension	80	100	120
Price in €/pcs	With VAT	With VAT	With VAT
<b>TM</b> 1 Testa di Moro RAL 8028	<b>5,10</b> 017581	<b>5,28</b> 017598	<b>5,88</b> 017604
<b>AN</b> 2 Anthracite RAL 7016	<b>5,10</b> 017284	<b>5,28</b> 017291	<b>5,88</b> 017307
<b>IC</b> 3 Intense black RAL 9005	<b>5,10</b> 017345	<b>5,28</b> 017352	<b>5,88</b> 017369
<b>OC</b> 4 Steel red RAL 3009	<b>5,10</b> 017499	<b>5,28</b> 017505	<b>5,88</b> 017512
<b>MH</b> 5 Copper brown RAL 8004	<b>5,10</b> 017376	<b>5,28</b> 017383	<b>5,88</b> 017390
<b>SB</b> 6 Grey white RAL 9002	<b>5,10</b> 017550	<b>5,28</b> 017567	<b>5,88</b> 017574
<b>BH</b> 7 White aluminum RAL 9006	<b>5,10</b> 017314	<b>5,28</b> 017321	<b>5,88</b> 017338
<b>PS</b> 8 Dusty grey RAL 7037	<b>5,10</b> 017529	<b>5,28</b> 017536	<b>5,88</b> 017543
<b>MM</b> 9 Metallic copper RAL extra	<b>5,10</b> 017406	<b>5,28</b> 017413	<b>5,88</b> 017420
<b>BHT – P.20</b> 10 Grey aluminum RAL 9007	<b>5,10</b> 095657 *	<b>5,28</b> 095664	<b>5,88</b> 095671 *
<b>MZ</b> 11 Moss green RAL 6005	<b>5,10</b> 017468 *	<b>5,28</b> 017475	<b>5,88</b> 017482
<b>MOT</b> 12 Gentian blue RAL 5010	<b>5,10</b> 017437 *	<b>5,28</b> 017444	<b>5,88</b> 017451
<b>TZ</b> 13 Reseda green RAL 6011	<b>5,10</b> 017611 *	<b>5,28</b> 017628	<b>5,88</b> 017635 *
<b>Package in pcs</b>	<b>10</b>	<b>10</b>	<b>8</b>
<b>Package in pcs</b>	<b>900</b>	<b>900</b>	<b>720</b>

\* Custom production

GALV. STEEL  
POLYESTER



# GALVANIZED STEEL POLYESTER

## DOUBLE ELBOW

P-PKO



Nominal dimension	80	100	120
Price in €/pcs	With VAT	With VAT	With VAT
<b>TM</b> 1 Testa di Moro RAL 8028	<b>11,28</b> 034045	<b>11,64</b> 034052	<b>16,74</b> 034069
<b>AN</b> 2 Anthracite RAL 7016	<b>11,28</b> 033741	<b>11,64</b> 033758	<b>16,74</b> 033765
<b>IC</b> 3 Intense black RAL 9005	<b>11,28</b> 033802	<b>11,64</b> 033819	<b>16,74</b> 033826
<b>OC</b> 4 Steel red RAL 3009	<b>11,28</b> 033956	<b>11,64</b> 033963	<b>16,74</b> 033970
<b>MH</b> 5 Copper brown RAL 8004	<b>11,28</b> 033833	<b>11,64</b> 033840	<b>16,74</b> 033857
<b>SB</b> 6 Grey white RAL 9002	<b>11,28</b> 034014	<b>11,64</b> 034021	<b>16,74</b> 034038
<b>BH</b> 7 White aluminum RAL 9006	<b>11,28</b> 033772	<b>11,64</b> 033789	<b>16,74</b> 033796
<b>PS</b> 8 Dusty grey RAL 7037	<b>11,28</b> 033987	<b>11,64</b> 033994	<b>16,74</b> 034007
<b>MM</b> 9 Metallic copper RAL extra	<b>11,28</b> 033864	<b>11,64</b> 033871	<b>16,74</b> 033888
<b>BHT – P.20</b> 10 Grey aluminum RAL 9007	<b>11,28</b> 095688	<b>11,64</b> 095695	<b>16,74</b> 095701
<b>MZ</b> 11 Moss green RAL 6005	<b>11,28</b> 033925	<b>11,64</b> 033932	<b>16,74</b> 033949
<b>MOT</b> 12 Gentian blue RAL 5010	<b>11,28</b> 033895	<b>11,64</b> 033901	<b>16,74</b> 033918
<b>TZ</b> 13 Reseda green RAL 6011	<b>11,28</b> 034076	<b>11,64</b> 034083	<b>16,74</b> 034090
<b>Package in pcs</b> 📦	<b>20</b>	<b>20</b>	<b>15</b>
<b>Package in pcs</b> 🚚	<b>320</b>	<b>240</b>	<b>180</b>

GALV. STEEL  
POLYESTER

# GALVANIZED STEEL POLYESTER

## DOWNPIPE BRANCH 72°

P-PZO

Nominal dimension	80/80	100/60	100/80	100/100
Price in €/pcs	With VAT	With VAT	With VAT	With VAT
<b>TM</b> 1 Testa di Moro RAL 8028	<b>18,78</b> 016157	<b>20,88</b> 016164	<b>20,88</b> 016171	<b>21,60</b> 016188
<b>AN</b> 2 Anthracite RAL 7016	<b>18,78</b> 015259	<b>20,88</b> 015266	<b>20,88</b> 015273	<b>21,60</b> 015280
<b>IC</b> 3 Intense black RAL 9005	<b>18,78</b> 015433	<b>20,88</b> 015440	<b>20,88</b> 015457	<b>21,60</b> 015464
<b>OC</b> 4 Steel red RAL 3009	<b>18,78</b> 015884	<b>20,88</b> 015891	<b>20,88</b> 015907	<b>21,60</b> 015914
<b>MH</b> 5 Copper brown RAL 8004	<b>18,78</b> 015525	<b>20,88</b> 015532 *	<b>20,88</b> 015549	<b>21,60</b> 015556
<b>SB</b> 6 Grey white RAL 9002	<b>18,78</b> 016065	<b>20,88</b> 016072 *	<b>20,88</b> 016089	<b>21,60</b> 016096
<b>BH</b> 7 White aluminum RAL 9006	<b>18,78</b> 015341	<b>20,88</b> 015358 *	<b>20,88</b> 015365	<b>21,60</b> 015372
<b>PS</b> 8 Dusty grey RAL 7037	<b>18,78</b> 015976 *	<b>20,88</b> 015983 *	<b>20,88</b> 015990	<b>21,60</b> 016003
<b>MM</b> 9 Metallic copper RAL extra	<b>18,78</b> 015617	<b>20,88</b> 015624 *	<b>20,88</b> 015631	<b>21,60</b> 015648
<b>BHT – P.20</b> 10 Grey aluminum RAL 9007	<b>18,78</b> 096005 *		<b>20,88</b> 096012 *	<b>21,60</b> 096029 *
<b>MZ</b> 11 Moss green RAL 6005	<b>18,78</b> 015792	<b>20,88</b> 015808 *	<b>20,88</b> 015815	<b>21,60</b> 015822
<b>MOT</b> 12 Gentian blue RAL 5010	<b>18,78</b> 015709 *	<b>20,88</b> 015716 *	<b>20,88</b> 015723 *	<b>21,60</b> 015730
<b>TZ</b> 13 Reseda green RAL 6011	<b>18,78</b> 016249 *	<b>20,88</b> 016256 *	<b>20,88</b> 016263 *	<b>21,60</b> 016270 *
Package in pcs	<b>4</b>	<b>4</b>	<b>4</b>	<b>4</b>
Package in pcs	<b>120</b>	<b>120</b>	<b>120</b>	<b>120</b>

\* Custom production



GALV. STEEL  
POLYESTER

# GALVANIZED STEEL POLYESTER

## DOWNPIPE BRANCH 72°

P-PZO



Nominal dimension	120/80	120/100	120/120	150/120	150/150
Price in €/pcs	With VAT	With VAT	With VAT	With VAT	With VAT
<b>TM</b> 1 Testa di Moro RAL 8028	<b>23,76</b>	<b>23,76</b>	<b>23,76</b>	<b>34,56</b>	<b>34,56</b>
	016195	016201	016218	016225 *	016232 *
<b>AN</b> 2 Anthracite RAL 7016	<b>23,76</b>	<b>23,76</b>	<b>23,76</b>	<b>34,56</b>	<b>34,56</b>
	015297	015303	015310	015327 *	015334 *
<b>IC</b> 3 Intense black RAL 9005	<b>23,76</b>	<b>23,76</b>	<b>23,76</b>	<b>34,56</b>	<b>34,56</b>
	015471	015488	015495	015501 *	015518 *
<b>OC</b> 4 Steel red RAL 3009	<b>23,76</b>	<b>23,76</b>	<b>23,76</b>	<b>34,56</b>	<b>34,56</b>
	015921	015938	015945	015952 *	015969 *
<b>MH</b> 5 Copper brown RAL 8004	<b>23,76</b>	<b>23,76</b>	<b>23,76</b>	<b>34,56</b>	<b>34,56</b>
	015563	015570	015587	015594 *	015600 *
<b>SB</b> 6 Grey white RAL 9002	<b>23,76</b>	<b>23,76</b>	<b>23,76</b>	<b>34,56</b>	<b>34,56</b>
	016102	016119	016126	016133 *	016140 *
<b>BH</b> 7 White aluminum RAL 9006	<b>23,76</b>	<b>23,76</b>	<b>23,76</b>	<b>34,56</b>	<b>34,56</b>
	015389	015396	015402	015419 *	015426 *
<b>PS</b> 8 Dusty grey RAL 7037	<b>23,76</b>	<b>23,76</b>	<b>23,76</b>	<b>34,56</b>	<b>34,56</b>
	016010 *	016027	016034	016041 *	016058 *
<b>MM</b> 9 Metallic copper RAL extra	<b>23,76</b>	<b>23,76</b>	<b>23,76</b>	<b>34,56</b>	<b>34,56</b>
	015655 *	015662	015679	015686 *	015693 *
<b>BHT – P.20</b> 10 Grey aluminum RAL 9007	<b>23,76</b>	<b>23,76</b>	<b>23,76</b>		
	096036 *	096043 *	096050 *		
<b>MZ</b> 11 Moss green RAL 6005	<b>23,76</b>	<b>23,76</b>	<b>23,76</b>	<b>34,56</b>	<b>34,56</b>
	015839 *	015846 *	015853 *	015860 *	015877 *
<b>MOT</b> 12 Gentian blue RAL 5010	<b>23,76</b>	<b>23,76</b>	<b>23,76</b>	<b>34,56</b>	<b>34,56</b>
	015747 *	015754 *	015761 *	015778 *	015785 *
<b>TZ</b> 13 Reseda green RAL 6011	<b>23,76</b>	<b>23,76</b>	<b>23,76</b>	<b>34,56</b>	<b>34,56</b>
	016287 *	016294 *	016300 *	016317 *	016324 *
<b>Package in pcs</b>	<b>3</b>	<b>3</b>	<b>3</b>	<b>2</b>	<b>2</b>
<b>Package in pcs</b>	<b>90</b>	<b>90</b>	<b>90</b>	<b>36</b>	<b>36</b>

\* Custom production

# GALVANIZED STEEL POLYESTER

## WATER DISTRIBUTORS

P-PRV

GALV. STEEL  
POLYESTER



Nominal dimension	80	100	120
Price in €/pcs	With VAT	With VAT	With VAT
<b>TM</b> 1 Testa di Moro RAL 8028	<b>234,00</b>	<b>239,88</b>	<b>310,80</b>
	088413 *	088420	088437 *
<b>AN</b> 2 Anthracite RAL 7016	<b>234,00</b>	<b>239,88</b>	<b>310,80</b>
	088116 *	088123	088130 *
<b>IC</b> 3 Intense black RAL 9005	<b>234,00</b>	<b>239,88</b>	<b>310,80</b>
	088178 *	088185 *	088192 *
<b>OC</b> 4 Steel red RAL 3009	<b>234,00</b>	<b>239,88</b>	<b>310,80</b>
	088321 *	088338 *	088345 *
<b>MH</b> 5 Copper brown RAL 8004	<b>234,00</b>	<b>239,88</b>	<b>310,80</b>
	088208 *	088215 *	088222 *
<b>SB</b> 6 Grey white RAL 9002	<b>234,00</b>	<b>239,88</b>	<b>310,80</b>
	088383 *	088390 *	088406 *
<b>BH</b> 7 White aluminum RAL 9006	<b>234,00</b>	<b>239,88</b>	<b>310,80</b>
	088147 *	088154 *	088161 *
<b>PS</b> 8 Dusty grey RAL 7037	<b>234,00</b>	<b>239,88</b>	<b>310,80</b>
	088352 *	088369 *	088376 *
<b>MM</b> 9 Metallic copper RAL extra	<b>234,00</b>	<b>239,88</b>	<b>310,80</b>
	088239 *	088246 *	088253 *
<b>BHT – P.20</b> 10 Grey aluminum RAL 9007	<b>234,00</b>	<b>239,88</b>	<b>310,80</b>
	095756 *	095763 *	095770 *
<b>MZ</b> 11 Moss green RAL 6005	<b>234,00</b>	<b>239,88</b>	<b>310,80</b>
	088291 *	088307 *	088314 *
<b>MOT</b> 12 Gentian blue RAL 5010	<b>234,00</b>	<b>239,88</b>	<b>310,80</b>
	088260 *	088277 *	088284 *
<b>TZ</b> 13 Reseda green RAL 6011	<b>234,00</b>	<b>239,88</b>	<b>310,80</b>
	088444 *	088451 *	088468 *
Package in pcs	1	1	1
Package in pcs	–	–	–



\* Custom production

# GALVANIZED STEEL POLYESTER

## DOWNPIPE BRACKET WITH PIN 150 mm

P-PO





Nominal dimension	80	100	120
<b>Price in €/pcs</b>	With VAT	With VAT	With VAT
<b>TM</b> 1 Testa di Moro RAL 8028	<b>3,96</b> 002136	<b>4,02</b> 002143	<b>4,80</b> 002150
<b>AN</b> 2 Anthracite RAL 7016	<b>3,96</b> 001986	<b>4,02</b> 001993	<b>4,80</b> 002006
<b>IC</b> 3 Intense black RAL 9005	<b>3,96</b> 002013	<b>4,02</b> 002020	<b>4,80</b> 002037
<b>OC</b> 4 Steel red RAL 3009	<b>3,96</b> 002075	<b>4,02</b> 002082	<b>4,80</b> 002099
<b>MH</b> 5 Copper brown RAL 8004	<b>3,96</b> 002044	<b>4,02</b> 002051	<b>4,80</b> 002068
<b>SB</b> 6 Grey white RAL 9002	<b>3,96</b> 002105	<b>4,02</b> 002112	<b>4,80</b> 002129
<b>Package in pcs</b> 	<b>25</b>	<b>25</b>	<b>25</b>
<b>Package in pcs</b> 	<b>1 000</b>	<b>1 000</b>	<b>1 000</b>

GALV. STEEL  
POLYESTER

## DOWNPIPE BRACKET WITH PIN 200 mm

P-POD





Nominal dimension	80	100	120
<b>Price in €/pcs</b>	With VAT	With VAT	With VAT
<b>TM</b> 1 Testa di Moro RAL 8028	<b>4,20</b> 001955	<b>4,20</b> 001962	<b>4,86</b> 001979
<b>AN</b> 2 Anthracite RAL 7016	<b>4,20</b> 001801	<b>4,20</b> 001818	<b>4,86</b> 001825
<b>IC</b> 3 Intense black RAL 9005	<b>4,20</b> 001832	<b>4,20</b> 001849	<b>4,86</b> 001856
<b>OC</b> 4 Steel red RAL 3009	<b>4,20</b> 001894	<b>4,20</b> 001900	<b>4,86</b> 001917
<b>MH</b> 5 Copper brown RAL 8004	<b>4,20</b> 001863	<b>4,20</b> 001870	<b>4,86</b> 001887
<b>SB</b> 6 Grey white RAL 9002	<b>4,20</b> 001924	<b>4,20</b> 001931	<b>4,86</b> 001948
<b>Package in pcs</b> 	<b>25</b>	<b>25</b>	<b>25</b>
<b>Package in pcs</b> 	<b>1 000</b>	<b>1 000</b>	<b>1 000</b>

# GALVANIZED STEEL POLYESTER

## DOWNPIPE BRACKET WITH PIN 300 mm

P-PODD

Nominal dimension	100	120
Price in €/pcs	With VAT	With VAT
<b>TM</b> 1 Testa di Moro RAL 8028	<b>5,46</b> 002402	<b>5,94</b> 002419
<b>AN</b> 2 Anthracite RAL 7016	<b>5,46</b> 002303	<b>5,94</b> 002310
<b>IC</b> 3 Intense black RAL 9005	<b>5,46</b> 002327	<b>5,94</b> 002334
<b>OC</b> 4 Steel red RAL 3009	<b>5,46</b> 002365	<b>5,94</b> 002372
<b>MH</b> 5 Copper brown RAL 8004	<b>5,46</b> 002341	<b>5,94</b> 002358
<b>SB</b> 6 Grey white RAL 9002	<b>5,46</b> 002389	<b>5,94</b> 002396
Package in pcs 	<b>20</b>	<b>20</b>
Package in pcs 	<b>800</b>	<b>800</b>



GALV. STEEL  
POLYESTER





## PIPE BRACKET WITH THREAD M10

## P-POB

Nominal dimension	60	80	100	120	150
Price in €/pcs	With VAT	With VAT	With VAT	With VAT	With VAT
<b>TM</b> 1 Testa di Moro RAL 8028	<b>3,48</b> 074119	<b>3,18</b> 074126	<b>3,30</b> 074133	<b>3,96</b> 074140	<b>5,88</b> 074157
<b>AN</b> 2 Anthracite RAL 7016	<b>3,48</b> 073471	<b>3,18</b> 073488	<b>3,30</b> 073495	<b>3,96</b> 073501	<b>5,88</b> 073518
<b>IC</b> 3 Intense black RAL 9005	<b>3,48</b> 073679	<b>3,18</b> 073686	<b>3,30</b> 073693	<b>3,96</b> 073709	<b>5,88</b> 073716
<b>OC</b> 4 Steel red RAL 3009	<b>3,48</b> 073914	<b>3,18</b> 073921	<b>3,30</b> 073938	<b>3,96</b> 073945	<b>5,88</b> 073952
<b>MH</b> 5 Copper brown RAL 8004	<b>3,48</b> 073723	<b>3,18</b> 073730	<b>3,30</b> 073747	<b>3,96</b> 073754	<b>5,88</b> 073761
<b>SB</b> 6 Grey white RAL 9002	<b>3,48</b> 074010	<b>3,18</b> 074027	<b>3,30</b> 074034	<b>3,96</b> 074041	<b>5,88</b> 074058
<b>BH</b> 7 White aluminum RAL 9006	<b>3,48</b> 073570	<b>3,18</b> 073587	<b>3,30</b> 073594	<b>3,96</b> 073600	<b>5,88</b> 073617
<b>PS</b> 8 Dusty grey RAL 7037	<b>3,48</b> 073969	<b>3,18</b> 073976	<b>3,30</b> 073983	<b>3,96</b> 073990	<b>5,88</b> 074003
<b>MM</b> 9 Metallic copper RAL extra	<b>3,48</b> 073778	<b>3,18</b> 073785	<b>3,30</b> 073792	<b>3,96</b> 073808	<b>5,88</b> 077158
<b>BHT – P.20</b> 10 Grey aluminum RAL 9007	<b>3,48</b> 119711	<b>3,18</b> 094537	<b>3,30</b> 094544	<b>3,96</b> 094551	<b>5,88</b> 094674
<b>MZ</b> 11 Moss green RAL 6005	<b>3,48</b> 073860	<b>3,18</b> 073877	<b>3,30</b> 073884	<b>3,96</b> 073891	<b>5,88</b> 073907
<b>MOT</b> 12 Gentian blue RAL 5010	<b>3,48</b> 073815	<b>3,18</b> 073822	<b>3,30</b> 073839	<b>3,96</b> 073846	<b>5,88</b> 073853
<b>TZ</b> 13 Reseda green RAL 6011	<b>3,48</b> 074164 *	<b>3,18</b> 074171	<b>3,30</b> 074188	<b>3,96</b> 074195	<b>5,88</b> 074201 *
Package in pcs	<b>25</b>	<b>25</b>	<b>25</b>	<b>25</b>	<b>20</b>
Package in pcs	<b>3 000</b>	<b>3 000</b>	<b>3 000</b>	<b>3 000</b>	<b>2 400</b>

\* Custom production



# GALVANIZED STEEL POLYESTER

## PIPE BRACKET WITH THREAD M8

P-POB





Nominal dimension	60	80	100	120	150
<b>Price in €/pcs</b>	With VAT	With VAT	With VAT	With VAT	With VAT
<b>TM</b> 1 Testa di Moro RAL 8028	<b>3,48</b>	<b>3,18</b>	<b>3,30</b>	<b>3,96</b>	<b>5,88</b>
	074065	074072	074089	074096	074102
<b>AN</b> 2 Anthracite RAL 7016	<b>3,48</b>	<b>3,18</b>	<b>3,30</b>	<b>3,96</b>	<b>5,88</b>
	073426	073433	073440	073457	073464
<b>IC</b> 3 Intense black RAL 9005	<b>3,48</b>	<b>3,18</b>	<b>3,30</b>	<b>3,96</b>	<b>5,88</b>
	073624	073631	073648	073655	073662
<b>BH</b> 7 White aluminum RAL 9006	<b>3,48</b>	<b>3,18</b>	<b>3,30</b>	<b>3,96</b>	<b>5,88</b>
	073532	073525	073549	073556	073563
<b>Package in pcs</b>	<b>25</b>	<b>25</b>	<b>25</b>	<b>25</b>	<b>20</b>
<b>Package in pcs</b>	<b>3 000</b>	<b>3 000</b>	<b>3 000</b>	<b>3 000</b>	<b>2 400</b>



# GALVANIZED STEEL POLYESTER

## STAINLESS STEEL SCREW FOR DOWNPIPE BRACKET M6x20 P-POB-NSK





Nominal dimension	EAN product number	Packaging in pcs		Price with VAT [€/pcs]
				
M6 x 20 *	071675	1	–	0,18

\* Custom production



## SCREW FOR DOWNPIPE BRACKET WITH THREADED TORX M10 P-POB-HT



Nominal dimension	EAN product number	Packaging in pcs		Price with VAT [€/pcs]
				
80	002464	100	40 000	1,20
140	002471	100	28 000	1,50
200	002488	100	20 000	1,86
250	002495	100	16 000	2,04
300	002501	100	11 200	2,04



## DOWEL M10 P-POB-HN DB



Nominal dimension	EAN product number	Packaging in pcs		Price with VAT [€/pcs]
				
120	002426	100	25 000	0,48



## DOWEL WITH LAMELLA M10 P-POB-HN DB



Nominal dimension	EAN product number	Packaging in pcs		Price with VAT [€/pcs]
				
180	002433	100	12 000	0,50
240	002440	100	12 000	0,60
280	002457	100	12 000	0,64

## COMBISCREW TORX M10 P-POB-ZT/SZ



Nominal dimension	EAN product number	Packaging in pcs		Price with VAT [€/pcs]
				
140	002587	50	10 400	0,54
180	002594	50	10 400	0,66

# GALVANIZED STEEL POLYESTER

## DOWEL FOR DOWNPIPE BRACKET SQUARE PIM 7x7

P-POB-HN R1



Nominal dimension	EAN product number	Packaging in pcs		Price with VAT [€/pcs]
200/60	002600	250	15 000	0,22

## INSULATION DOWEL M10

P-POB-HN IZOL



Nominal dimension	EAN product number	Packaging in pcs		Price with VAT [€/pcs]
M10 x 96	001207	25	2 625	3,24

## INSULATING DOWEL TIP OF THE BRICK WITHOUT INSULATION

P-POB-HN WDVS140 M10



Nominal dimension	EAN product number	Packaging in pcs		Price with VAT [€/pcs]
140	144843	1/5	750	5,76

## INSULATING DOWEL TIP OF THE BRICK WITH INSULATION

P-POB-HN WDVS300 M10



Nominal dimension	EAN product number	Packaging in pcs		Price with VAT [€/pcs]
300	144850	1/5	500	9,36

## STAINLESS STEEL UNI PLATFORM TO ATTACH OB M10

P-POB-HN PLAT M10



Nominal dimension	EAN product number	Packaging in pcs		Price with VAT [€/pcs]
M10	144836	25/500	5 000	4,02

## THREADED ROD M10

P-POB-ZT



Nominal dimension	EAN product number	Packaging in pcs		Price with VAT [€/pcs]
60	002556	100	20 800	0,24
100	002563	100	15 600	0,36
150	002570	50	10 400	0,66

# GALVANIZED STEEL POLYESTER

## DOWNPIPE BRACKET MOUNTING PLATE M10

## P-POB-ZT MP



Nominal dimension	EAN product number	Packaging in pcs		Price with VAT [€/pcs]
80 x 30	002518	25	5 200	1,38

## SCREW FOR DOWNPIPE BRACKET WITH THREADED M8

## P-POB-HB



Nominal dimension	EAN product number	Packaging in pcs		Price with VAT [€/pcs]
150	071590	100	5 000	0,78
200	071606	100	5 000	1,10
250	071613	100	5 000	1,26
300	071620	100	5 000	1,32

## DOWEL M8

## P-POB-HBN-SS



Nominal dimension	EAN product number	Packaging in pcs		Price with VAT [€/pcs]
150	071637	100	5 000	0,24
200	071644	100	5 000	0,30
250	071651	100	5 000	0,30
300	071668	100	8 000	0,44

## RUBBER CAP FOR DOWNPIPE BRACKET SCREW

## P-POB-HT AKG



Nominal dimension	EAN product number	Packaging in pcs		Price with VAT [€/pcs]
29 x 13	002280	50	16 800	0,30
29 x 13	002211	50	16 800	0,30
29 x 13	002235	50	16 800	0,30
29 x 13	002266	50	16 800	0,30
29 x 13	002242	50	16 800	0,30
29 x 13	002228	50	16 800	0,30
29 x 13	002273	50	16 800	0,30
29 x 13	002259	50	16 800	0,30
29 x 13	002297	50	16 800	0,30

# GALVANIZED STEEL POLYESTER

## DOWNPIPE FLAP

P-PZV



Nominal dimension	80	100	120
Price in €/pcs	With VAT	With VAT	With VAT
<b>TM</b> 1 Testa di Moro RAL 8028	<b>15,06</b> 034533	<b>15,54</b> 034540	<b>22,80</b> 034557
<b>AN</b> 2 Anthracite RAL 7016	<b>15,06</b> 034410	<b>15,54</b> 034427	<b>22,80</b> 034434
<b>IC</b> 3 Intense black RAL 9005	<b>15,06</b> 034441	<b>15,54</b> 034458	<b>22,80</b> 034465
<b>OC</b> 4 Steel red RAL 3009	<b>15,06</b> 034502	<b>15,54</b> 034519	<b>22,80</b> 034526
<b>MH</b> 5 Copper brown RAL 8004	<b>15,06</b> 034472	<b>15,54</b> 034489	<b>22,80</b> 034496
<b>Package in pcs</b>	<b>6</b>	<b>5</b>	<b>3</b>
<b>Package in pcs</b>	<b>180</b>	<b>150</b>	<b>90</b>

GALV. STEEL  
POLYESTER

## DOWNPIPE FLAP WITH SIEVE

P-PZVS



Nominal dimension	80	100	120
Price in €/pcs	With VAT	With VAT	With VAT
<b>TM</b> 1 Testa di Moro RAL 8028	<b>15,06</b>	<b>15,54</b>	<b>22,80</b>
	034861	034878	034885
<b>AN</b> 2 Anthracite RAL 7016	<b>15,06</b>	<b>15,54</b>	<b>22,80</b>
	034564	034571	034588
<b>IC</b> 3 Intense black RAL 9005	<b>15,06</b>	<b>15,54</b>	<b>22,80</b>
	034625	034632	034649
<b>OC</b> 4 Steel red RAL 3009	<b>15,06</b>	<b>15,54</b>	<b>22,80</b>
	034779	034786	034793
<b>MH</b> 5 Copper brown RAL 8004	<b>15,06</b>	<b>15,54</b>	<b>22,80</b>
	034656	034663	034670
<b>SB</b> 6 Grey white RAL 9002	<b>15,06</b>	<b>15,54</b>	<b>22,80</b>
	034830	034847	034854
<b>BH</b> 7 White aluminum RAL 9006	<b>15,06</b>	<b>15,54</b>	<b>22,80</b>
	034595	034601	034618
<b>PS</b> 8 Dusty grey RAL 7037	<b>15,06</b>	<b>15,54</b>	<b>22,80</b>
	034809	034816	034823
<b>MM</b> 9 Metallic copper RAL extra	<b>15,06</b>	<b>15,54</b>	<b>22,80</b>
	034687	034694	034700
<b>BHT – P.20</b> 10 Grey aluminum RAL 9007	<b>15,06</b>	<b>15,54</b>	<b>22,80</b>
	095718	095725	095732
<b>MZ</b> 11 Moss green RAL 6005	<b>15,06</b>	<b>15,54</b>	<b>22,80</b>
	034748	034755	034762
<b>MOT</b> 12 Gentian blue RAL 5010	<b>15,06</b>	<b>15,54</b>	<b>22,80</b>
	034717	034724	034731
<b>TZ</b> 13 Reseda green RAL 6011	<b>15,06</b>	<b>15,54</b>	<b>22,80</b>
	034892 *	034908	034915
<b>Package in pcs</b>	<b>6</b>	<b>5</b>	<b>3</b>
<b>Package in pcs</b>	<b>180</b>	<b>150</b>	<b>90</b>

\* Custom production

# GALVANIZED STEEL POLYESTER

## ALUMINIUM WATER COLLECTOR+HOSE

P-PZVHA



GALV. STEEL  
POLYESTER

Nominal dimension	80	120
Price in €/pcs	With VAT	With VAT
<b>TM</b> 1 Testa di Moro RAL 8028	<b>78,00</b> 018793	<b>150,00</b> 018816
<b>AN</b> 2 Anthracite RAL 7016	<b>78,00</b> 018496	<b>150,00</b> 018519
<b>IC</b> 3 Intense black RAL 9005	<b>78,00</b> 018557	<b>150,00</b> 018571
<b>OC</b> 4 Steel red RAL 3009	<b>78,00</b> 018700	<b>150,00</b> 018724 *
<b>MH</b> 5 Copper brown RAL 8004	<b>78,00</b> 018588 *	<b>150,00</b> 018601 *
<b>SB</b> 6 Grey white RAL 9002	<b>78,00</b> 018762 *	<b>150,00</b> 018786
<b>BH</b> 7 White aluminum RAL 9006	<b>78,00</b> 018526	<b>150,00</b> 018540
<b>PS</b> 8 Dusty grey RAL 7037	<b>78,00</b> 018731 *	<b>150,00</b> 018755 *
<b>MM</b> 9 Metallic copper RAL extra	<b>78,00</b> 018618 *	<b>150,00</b> 018632 *
<b>BHT – P.20</b> 10 Grey aluminum RAL 9007	<b>78,00</b> 095527 *	<b>150,00</b> 095541 *
<b>MZ</b> 11 Moss green RAL 6005	<b>78,00</b> 018670 *	<b>150,00</b> 018694 *
<b>MOT</b> 12 Gentian blue RAL 5010	<b>78,00</b> 018649 *	<b>150,00</b> 018663 *
<b>TZ</b> 13 Reseda green RAL 6011	<b>78,00</b> 018823 *	<b>150,00</b> 018847 *
Package in pcs	1	1
Package in pcs	60	60

\* Custom production



# GALVANIZED STEEL POLYESTER

## ALUMINIUM WATER COLLECTOR WITH HOSE AND KNOB

P-PZVHAG





Nominal dimension	100
Price in €/pcs	With VAT
<b>TM</b> 1 Testa di Moro RAL 8028	<b>72,00</b> 018809
<b>AN</b> 2 Anthracite RAL 7016	<b>72,00</b> 018502
<b>IC</b> 3 Intense black RAL 9005	– –
<b>OC</b> 4 Steel red RAL 3009	<b>72,00</b> 018717
<b>MH</b> 5 Copper brown RAL 8004	<b>72,00</b> 018595
<b>SB</b> 6 Grey white RAL 9002	<b>72,00</b> 018779
<b>BH</b> 7 White aluminum RAL 9006	– –
<b>PS</b> 8 Dusty grey RAL 7037	<b>72,00</b> 018748
<b>MM</b> 9 Metallic copper RAL extra	<b>72,00</b> 018625 *
<b>BHT – P.20</b> 10 Grey aluminum RAL 9007	<b>72,00</b> 095534 *
<b>MZ</b> 11 Moss green RAL 6005	– –
<b>MOT</b> 12 Gentian blue RAL 5010	<b>72,00</b> 018656 *
<b>TZ</b> 13 Reseda green RAL 6011	<b>72,00</b> 018830 *
<b>Package in pcs</b>	1
<b>Package in pcs</b>	60

\* Custom production

# GALVANIZED STEEL POLYESTER

## PROTEC.GUTTER PIPE COL.

## P-POZR

Nominal dimension	80	100	100
Length in m	1,0	1,0	1,5
Price in €/m	With VAT	With VAT	With VAT
<b>TM</b> 1 Testa di Moro RAL 8028	<b>76,80</b>	<b>58,80</b>	<b>116,40</b>
	010254 *	010261	010278
<b>AN</b> 2 Anthracite RAL 7016	<b>76,80</b>	<b>58,80</b>	<b>116,40</b>
	009760 *	009777	009784 *
<b>IC</b> 3 Intense black RAL 9005	<b>76,80</b>	<b>58,80</b>	<b>116,40</b>
	009869 *	009876	009883 *
<b>OC</b> 4 Steel red RAL 3009	<b>76,80</b>	<b>58,80</b>	<b>116,40</b>
	010117 *	010124 *	010131 *
<b>MH</b> 5 Copper brown RAL 8004	<b>76,80</b>	<b>58,80</b>	<b>116,40</b>
	009913 *	009920 *	009937 *
<b>SB</b> 6 Grey white RAL 9002	<b>76,80</b>	<b>58,80</b>	<b>116,40</b>
	010209 *	010247 *	010216 *
<b>BH</b> 7 White aluminum RAL 9006	<b>76,80</b>	<b>58,80</b>	<b>116,40</b>
	009814 *	009821 *	009838 *
<b>PS</b> 8 Dusty grey RAL 7037	<b>76,80</b>	<b>58,80</b>	<b>116,40</b>
	010162 *	010179 *	010186 *
<b>MM</b> 9 Metallic copper RAL extra	<b>76,80</b>	<b>58,80</b>	<b>116,40</b>
	009968 *	009975 *	009982 *
<b>BHT – P.20</b> 10 Grey aluminum RAL 9007	<b>76,80</b>	<b>58,80</b>	
	096494 *	096500 *	
<b>MZ</b> 11 Moss green RAL 6005	<b>76,80</b>	<b>58,80</b>	<b>116,40</b>
	010063 *	010070 *	010087 *
<b>MOT</b> 12 Gentian blue RAL 5010	<b>76,80</b>	<b>58,80</b>	<b>116,40</b>
	010018 *	010025 *	010032 *
<b>TZ</b> 13 Reseda green RAL 6011	<b>76,80</b>	<b>58,80</b>	<b>116,40</b>
	010308 *	010315 *	010322 *
Package in pcs 	1	1	1
Package in pcs 	70	60	60

\* Custom production



GALV. STEEL  
POLYESTER

# GALVANIZED STEEL POLYESTER

## PROTEC.GUTTER PIPE COL.

## P-POZR



Nominal dimension	120	120
Length in m	1,0	1,5
Price in €/m	With VAT	With VAT
<b>TM</b> Testa di Moro RAL 8028	<b>138,00</b>	<b>198,00</b>
	010285	010292 *
<b>AN</b> Anthracite RAL 7016	<b>138,00</b>	<b>198,00</b>
	009791 *	009807 *
<b>IC</b> Intense black RAL 9005	<b>138,00</b>	<b>198,00</b>
	009890 *	009906 *
<b>OC</b> Steel red RAL 3009	<b>138,00</b>	<b>198,00</b>
	010148 *	010155 *
<b>MH</b> Copper brown RAL 8004	<b>138,00</b>	<b>198,00</b>
	009944 *	009951 *
<b>SB</b> Grey white RAL 9002	<b>138,00</b>	<b>198,00</b>
	010223 *	010230 *
<b>BH</b> White aluminum RAL 9006	<b>138,00</b>	<b>198,00</b>
	009845 *	009852 *
<b>PS</b> Dusty grey RAL 7037	<b>138,00</b>	<b>198,00</b>
	010193 *	009753 *
<b>MM</b> Metallic copper RAL extra	<b>138,00</b>	<b>198,00</b>
	009999 *	010001 *
<b>BHT – P.20</b> Grey aluminum RAL 9007	<b>138,00</b>	
	096517 *	
<b>MZ</b> Moss green RAL 6005	<b>138,00</b>	<b>198,00</b>
	010094 *	010100 *
<b>MOT</b> Gentian blue RAL 5010	<b>138,00</b>	<b>198,00</b>
	010049 *	010056 *
<b>TZ</b> Reseda green RAL 6011	<b>138,00</b>	<b>198,00</b>
	010339 *	010346 *
Package in pcs	1	1
Package in pcs	40	40

\* Custom production

GALV. STEEL  
POLYESTER

## PIPE CLAMP WITH GASKET M10

## P-POB-OZR



Nominal dimension	EAN product number	Packaging in pcs		Price with VAT [€/pcs]
80	002525	25	1 250	1,86
100	002532	25	1 250	2,40
120	002549	20	1 000	2,70

# GALVANIZED STEEL POLYESTER

GALV. STEEL  
POLYESTER

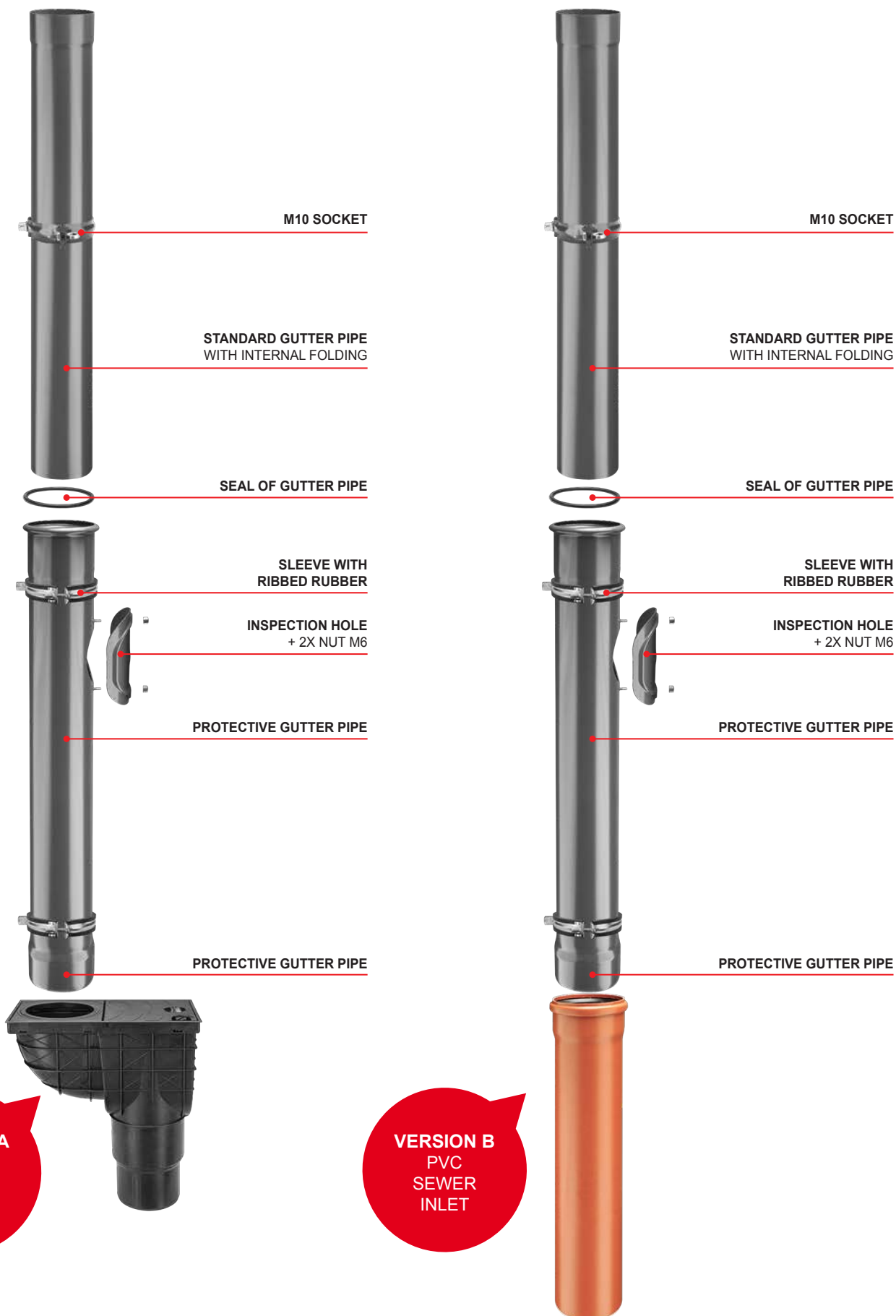

**VERSION A**  
PVC  
SEWER  
INLET

**VERSION B**  
PVC  
SEWER  
INLET

## I. BASIC PROVISIONS

- The company KJG a.s., with its registered office at Malinovského 800/131, 916 21 Čachtice, Company ID: 31 439 951 (hereinafter referred to as the „Seller“), issues the following General business terms and conditions that apply to the sale and supply of gutter roof system with accessories, light roofing, trapezoids, metallurgical materials, roofing accessories, tools, machinery and commercial goods related to the roof system (hereinafter referred to as the „goods“) performed by the Seller on the basis of a framework purchase contract (referred to as „FPC“) in relation to an entrepreneur in carrying out its business activities and to the state, state organization, self-governing territorial unit or to a legal entity established by law as a public institution in the provision of public needs or its own operation (hereinafter referred to as the „Buyer“).
- These General terms and conditions as an integrated part of FPC are an integral part of each individual purchase contract (hereinafter also „IPC“ or „contract“) concluded between the Seller and the Buyer on the basis of FPC.

## II. CONCLUSION OF PURCHASE CONTRACT

- The Buyer's written order is considered to be a proposal to conclude an IPC, whereby each Buyer's order should contain:
  - identification data of the Buyer necessary for issuing the invoice,
  - specification of the ordered goods (especially type, kind, quantity and dimensions),
  - delivery place, delivery time and method of delivery of goods,
  - date of issue of the order,
  - name, surname, position and signature of the person authorized to act on behalf of the Buyer.
- The IPC is considered closed at the moment of written confirmation of the Buyer's order by the Seller.

## III. PURCHASE PRICE AND PAYMENT TERMS

- The Buyer undertakes to pay the Seller the purchase price for the ordered goods properly and in due time. The purchase price is determined according to the Seller's price list (prices of goods are to be understood without VAT) valid on the day of submitting the order by the Buyer and its amount will be stated by the Seller in the Buyer's order confirmation including VAT (when delivering goods in Slovakia) according to valid legal regulations. In necessary cases, if the purchase price is determined on the basis of individual price calculation based on the valid price list, the Buyer shall be obliged to pay the purchase price up to the amount determined by price calculation on condition that the Seller shall determine the final purchase price according to costs incurred, but this shall not exceed the purchase price determined by calculation. The buyer is entitled to a discount on the price of the goods in the amount resulting from the FPC; if the Seller changes the amount of the Buyer's discount on the price of the goods during the FPC period, it shall immediately inform the Buyer in writing. When delivering the goods in the Slovak Republic, the Seller charges the Buyer, in addition to the price of the goods, VAT in accordance with the valid legal regulations.
- The Buyer shall have a set financial credit limit for the purchase of goods and the maturity of invoices in accordance with the FPC, while the Seller shall be entitled to invoice the purchase price to the Buyer on the day of delivery or shipping the goods to the Buyer, respectively. After overdrawing the credit limit specified in the FPC or in the case of non-payment of the invoice by the Buyer within the due date, the Seller is entitled to interrupt the delivery of goods to the Buyer on the basis of the contract and not to confirm another written order of the Buyer. The Seller shall continue with further deliveries of goods:
  - in the case of exceeded credit limit - after payment of the oldest invoices up to the amount of exceeding the credit limit and simultaneous payment of the value of the required purchase of goods,
  - in the case of non-payment of the invoice within the due date - after its full payment. The Seller shall be entitled to change the credit limit set for the Buyer at any time throughout the duration of the FPC.
- Payment shall be deemed to have been made in time if it has been credited to the Seller's account or paid in cash at the Seller's cash desk by the due date.
- If the Buyer does not pay the invoice within the due date, the Seller shall be entitled to charge the Buyer for interest on late payment in the amount of 0.05 % of the unpaid amount for each day of delay.

## IV. DELIVERY OF GOODS AND RETENTION OF TITLE

- The Seller shall be obliged to deliver the goods to the Buyer in the quantity agreed in the contract and in a quality and design that is suitable for the purpose for which the goods are used. The Buyer is obliged to take over the goods delivered by the Seller.
- Unless the contracting parties have agreed otherwise, the Seller is obliged to pack or arrange the goods for transport in the manner that is usual for such goods in business.
- Delivery of the goods shall take place within the period and in the manner agreed by the contracting parties in the contract.
- Upon delivery of the goods by the Seller, the Buyer's employee shall be obliged to prove the right to take over the goods.
- If the goods are to be made available not loaded on a means of transport at the Seller's registered office (or the relevant warehouse of the Seller, to which the Buyer has submitted an order) by the Buyer to the designated carrier, the latter is obliged to prove the right to take over the goods.
- In the event that the goods are to be delivered to the Buyer to the delivery point specified in the order using a Seller's vehicle, the Seller will charge the Buyer for transport costs according to the transport price list valid on the day of submitting the order by the Buyer. At the same time, the Seller reserves the right to unload the goods only in an available terrain at its sole discretion.
- In the case of goods to be sent to the Buyer, the Seller shall charge the Buyer for postage, unless agreed otherwise.
- The Buyer undertakes to withdraw the goods within the delivery period. If the Buyer fails to fulfil its obligation to take over the goods within the delivery period, the Seller shall invite the Buyer to fulfil the Seller's obligation within an additional reasonable period. Failure to take over the goods by the Buyer nor within an additional reasonable period gives rise to the Seller's right to withdraw from the contract.
- The buyer who does not pay the whole amount of the purchase price until the delivery of the goods will acquire ownership of the delivered goods only after full payment of the purchase price.

## V. PASSING OF RISK OF DAMAGE TO GOODS

- The risk of damage to the goods passes to the Buyer at the moment the Buyer takes over the goods from the Seller, or by the carrier designated by him, or if the Buyer fails to do so in time, at the time when the Seller or the Seller's designated carrier allows the Buyer to dispose of the goods, while the Buyer is being aware of this possibility and breaches the contract by not taking over the goods.
- If the Seller is to hand over the goods for transport by the carrier designated by the Buyer at its registered office in Čachtice (or the relevant warehouse of the Seller) from which the Buyer is to take over the goods, the risk of damage to the goods passes to the Buyer upon handing over the goods to this carrier.
- In the event that the Seller is to send the goods to the Buyer, the risk of damage to the goods passes to the Buyer at the time of delivery of the goods to the first carrier for transport to the destination.
- The buyer is obliged to inspect the goods without undue delay after the risk of damage to the goods has passed. If the goods are sent to the Buyer, the Buyer is obliged to inspect the goods without undue delay after their delivery to the destination. The company KJG a.s. reserves the right to change prices, packaging and printing.

## VI. LIABILITY FOR DEFECTS AND WARRANTY

- The Seller shall be responsible for the defect by which the goods have been affected at the moment when the risk of damage to the goods passes to the Buyer, even if the defect becomes apparent only after this time. The Seller is also responsible for any defect arising after the risk of damage to the goods has passed to the Buyer if caused by a breach of the Buyer's duties.
- If the Buyer does not inspect the goods or does not arrange to inspect them at the time of passing the risk of damage to the goods, the Buyer may claim for defects detectable during this inspection only if the Buyer proves that the goods were already affected by these defects at the time of passing the risk of damage to the goods.
- The Buyer shall be obliged to notify the Seller of defects in the goods without undue delay after:
  - The Buyer found the defects,
  - The Buyer, while exercising professional care, should have found defects during the inspection, which the Buyer is obliged to carry out after the risk of damage to the goods has passed, or
  - The defects could be found later with the exercise of professional care, but no later than within two years from the time of delivery of the goods, or from the arrival of the goods to the destination specified in the contract. For defects covered by the quality warranty, instead of this period of time the warranty period applies.
- If the Seller provides the Buyer with a warranty for the quality of the delivered goods, it shall do so by making a statement in a separate warranty card, which will also state the procedure for complaints.
- The warranty period begins to run from the date of delivery of the goods. If the Seller is obliged to send the goods, the warranty period runs from the day the goods arrive at its destination. The warranty period does not run for a period during which the Buyer cannot use the goods due to their defects, which is the Seller's responsibility.
- In the case of delivery of goods to the Buyer with defects, the use of prov. § 436, § 437, § 439 par. 2, 3, 4 and § 441 of the Commercial Code are explicitly excluded and the Seller in such a case shall provide the Buyer with a discount on the purchase price or shall remove the defects in the goods complained by the Buyer:
  - by delivery of missing goods,
  - by repair of goods or delivery of replacement goods in case of remediable defects
  - by delivery of replacement goods in the event of irreparable defects.
- The discount granted by the Seller on the purchase price shall correspond to the difference between the value of the goods without defects and the value of the goods delivered with defects, while the decisive time for determining the values is the time at which proper fulfillment should have taken place. The Buyer, to whom the Seller has been granted a discount on the purchase price, is not entitled to claim compensation for the loss of profit due to the lack of properties of the goods to which the discount applies.
- Upon delivery of replacement goods, the Seller shall be entitled to demand the exchanged goods to be returned to the Seller at the Buyer's expense in the condition in which they were delivered to the Buyer. This does not apply if the impossibility of returning the goods in the condition specified therein is not caused by the actions or omissions of the Buyer, or if the change in the condition of the goods occurred as a result of an inspection duly performed to detect defects in the goods. In the event that before the detection of defects the Buyer sold the goods or part thereof or consumed the goods in whole or in part or altered them in their normal use, the Buyer shall be obliged to return unsold or unconsumed goods or altered goods and provide the Seller with compensation to the extent to which the Seller has benefited from that use of the goods.
- The Seller's responsibility for defects not covered by the quality warranty does not arise if these defects were caused after the passing of the risk of damage to the goods by external events and were not caused by the Seller or the persons who helped to fulfil the Seller's obligation.

## VII. VIS MAJOR

- If, after the conclusion of the contract, unforeseeable and uncontrollable circumstances arise which create a permanent or temporary obstacle to the fulfillment of the obligations of the contracting parties of the concluded contract (refer to vis major), the non-fulfillment of obligations (in case of permanent obstacle) by a contracting party, or a delayed fulfillment of obligations (in case of temporary obstacle), shall not be considered a breach of this contract and the contracting party shall not be responsible for any damages that arise in connection with non-fulfillment of contractual obligations. If the obstacle incurred is only temporary for the fulfillment of obligations under the contract, the contracting parties undertake to start fulfilling their contractual obligations immediately after this obstacle disappears. Each contracting party shall be obliged to inform immediately the other contracting party of the occurrence of the above obstacles.
- The followings are mainly considered to be vis major: natural events, arbitrary acts of third parties, strikes, work lockouts, blockades, wars (declared or undeclared), a change in the political situation or any other similar event which precludes or unduly impedes the exercise of rights and obligations under the contract.

## VIII. PRIVACY POLICY

- The Buyer (for the purposes of this article also another person signed on the FPC and the order on behalf of the Buyer) expressly grants to the Seller, according to Act no. 428/2002 Coll. on personal data protection as amended (hereinafter referred to as the „Act“), consent to the processing of its personal data specified in the FPC and the Buyer's order.
- The Buyer expressly authorizes the Seller to process personal data for the purposes of:
  - exercise of the rights and obligations arising from the FPC and IPC,
  - keeping records, the obligation of which arises for the Seller by law or on the basis of the Act,
  - performing marketing activities.
- The Buyer expressly gives the Seller consent to provide the Buyer's personal data for the purposes stated in point 8.2 to a third party which has been entrusted by the Buyer with the activity in question.
- The Buyer expressly grants the Seller consent to the processing of personal data:
  - for the period in which the Seller is obliged to keep the records referred to in point 8.2. b /,
  - for the period in which it is necessary to protect the legal rights and legally protected interests of the Seller.
- The Buyer takes into account that it has the right to revoke its consent to the processing of personal data and require the liquidation of its personal data in the event that the Seller, or a third party to whom the Seller has provided personal data, respectively, breaches the obligations arising from the Act.

## IX. FINAL PROVISIONS

- The Buyer is not entitled to transfer or assign the rights resulting for the Buyer from the FPC or IPC to a third party without the express consent of the Seller.
- The FPC may be amended, unless otherwise provided in these General Terms and Conditions, only in the form of written amendments signed by representatives of both the contracting parties.
- The agreed deviating provisions in the IPC between the Seller and the Buyer take precedence over the provisions of the FPC and these General Terms and Conditions. Legal relations that are not regulated in the FPC, IPC or in these General Terms and Conditions are governed by the Commercial Code and other generally binding legal regulations in force in the Slovak Republic, excluding the use of conflicting rules of law and the application of the UN Convention on Contracts for the International Sale of Goods /CISG/ of April 11, 1980 and their possible amendments in the case the Buyer has its registered office (place of business) in another state or the goods are delivered to another state.
- All disputes arising from the implementation of the content of the FPC will be resolved by the contracting parties through an amicable settlement. Disputes that cannot be resolved by mutual agreement are entitled to be resolved (exclusively) by the competent court in the Slovak Republic.
- These General Terms and Conditions are issued by the Seller pursuant to § 273 of the Commercial Code, with effect from January 1, 2017.