



ACÉL

FES
TETT

ERESZCSATORNA RENDSZER FÉLKÖRÍVES



ÁRLISTA
2025

AJÁNLOTT FOGYASZTÓ ÁRAK



POWERFUL PARTNER FOR YOUR ROOF



Acél festett anyag | 3



Csatorna | 6



Dilatációs betét | 12



Csatorna tartozékok | 15



Csatornatartó | 19



Szeglet | 24



Véglemez | 26



Betorkollócsok | 28



Könyök | 40



Lefolyócső | 45



Lefolyócső tartozékok | 52



Bilincsfej | 55



Bilincsfej tartozékok | 58



Esőlopó | 61



Állványcső | 65

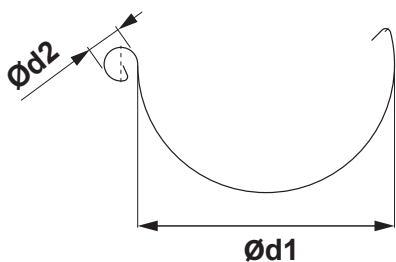

TETŐERESZ MÉRETEK

(méretek és méretbeli tűrések az EN 612 szerint)

Kiterített szélesség (mm)	200	250	280	333	400	500
Ød1	80	105	127	153	192	250
Ød2	16	18	18	20	22	22

BELSŐ FALC

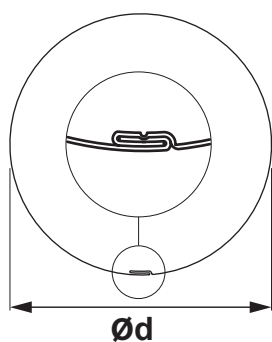

LEFOLYÓCSŐ MÉRETEK

(méretek és méretbeli tűrések az EN 612 szerint)

Méretek	60	80	100	120	150
Névleges méret Ød (mm)	60	80	100	120	150

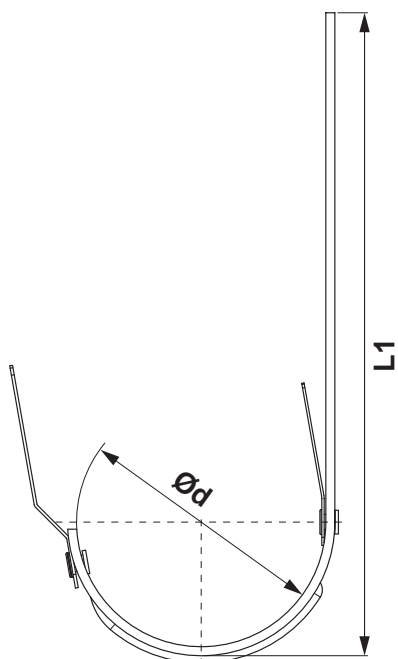

ERESZCSATORNA TARTÓ KAMPÓK MÉRETEI

(méretek és méretbeli tűrések az EN 612 szerint)

Méretek (mm)	L1	Ød
200	290	80
250	310	105
280	345	127
333 – 550	385	153
333 – 610	445	153
400	400	192

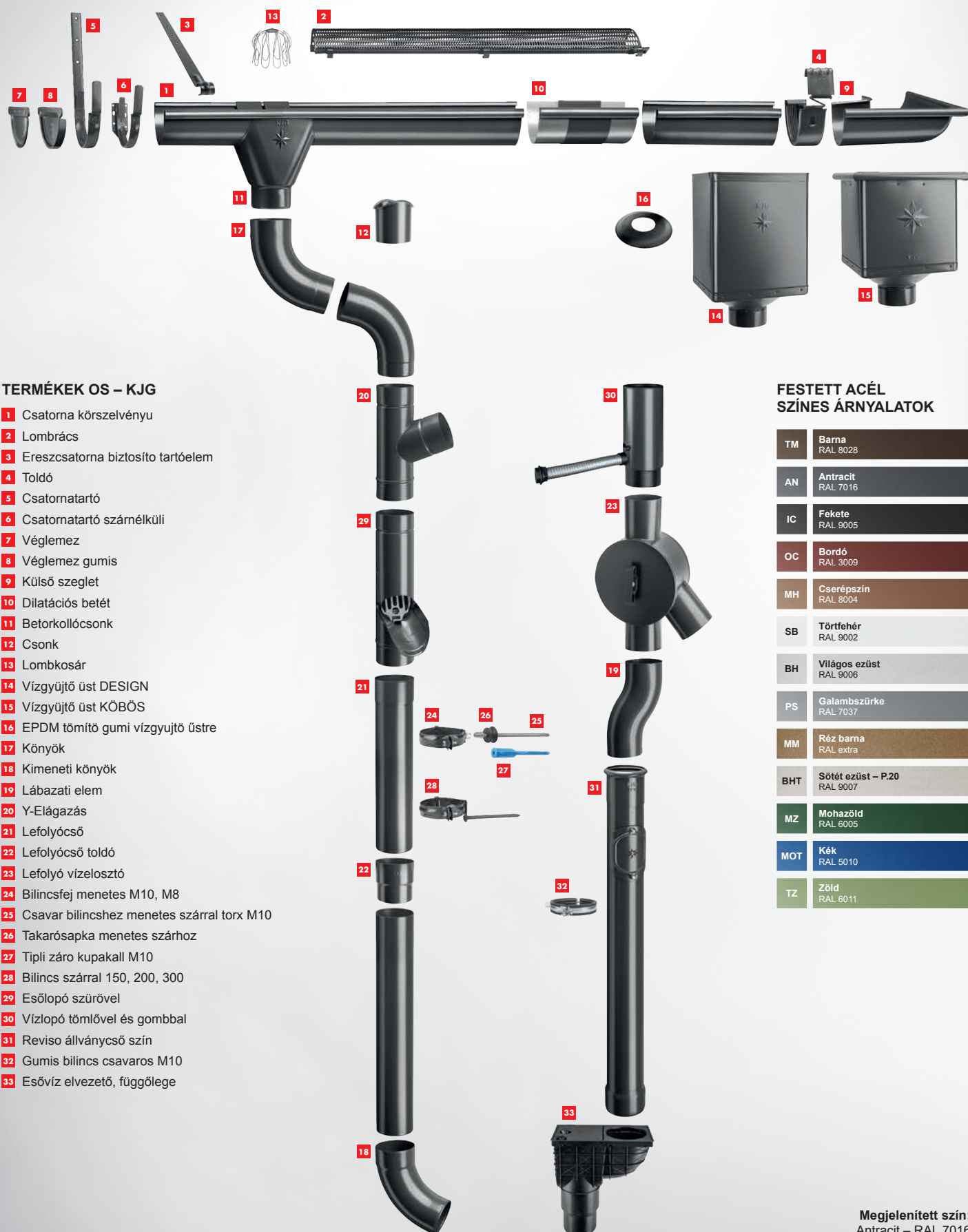

TERMÉKEK OS – KJG

- 1 Csatorna körszelvény
- 2 Lombrács
- 3 Ereszcsatorna biztosító tartóelem
- 4 Toldó
- 5 Csatornatartó
- 6 Csatornatartó szármélküli
- 7 Véglemez
- 8 Véglemez gumis
- 9 Külső szeglet
- 10 Dilatációs betét
- 11 Betorkollócsonk
- 12 Csonk
- 13 Lombkosár
- 14 Vízugyűjtő üst DESIGN
- 15 Vízugyűjtő üst KÖBÖS
- 16 EPDM tömítő gumi vízugyűjtő üstre
- 17 Könyök
- 18 Kimeneti könyök
- 19 Lábazati elem
- 20 Y-Elágazás
- 21 Lefolyócső
- 22 Lefolyócső toldó
- 23 Lefolyó vízelosztó
- 24 Bilincsfaj menetes M10, M8
- 25 Csavar bilincsfajhoz menetes szárral torx M10
- 26 Takarósapka menetes szárhoz
- 27 Tipti záro kupakall M10
- 28 Bilincsfaj szárral 150, 200, 300
- 29 Esőlopó szűrővel
- 30 Vízlöpő tömlővel és gombbal
- 31 Reviso állványcső szín
- 32 Gumis bilincsfaj csavaros M10
- 33 Esővíz elvezető, függőlege

FESTETT ACÉL SZÍNES ÁRNYALATOK

TM	Barna RAL 8028
AN	Antracit RAL 7016
IC	Fekete RAL 9005
OC	Bordó RAL 3009
MH	Cserépszín RAL 8004
SB	Törtfehér RAL 9002
BH	Világos ezüst RAL 9006
PS	Galambszürke RAL 7037
MM	Réz barna RAL extra
BHT	Sötét ezüst – P.20 RAL 9007
MZ	Mohazöld RAL 6005
MOT	Kék RAL 5010
TZ	Zöld RAL 6011

TATA STEEL





A Tata társaságot 1868-ban az indiai székhelyű Jamsetji Nusserwanji Tata társaság alapította. A csoport Földünk öt kontinensének több mint 100 országában működő globális üzleti konglomerátum. Az acélgártásban és az autópárban történő korai megjelenésétől a legújabb technológiákkal való lépéstartásig a Tata cégcsoport ma erős pozíciót foglal el különböző ágazatokban, mint például az agrokémia, az autópár, a vegyipar, az építőipar, a pénzügyek, a fogyasztási cikkek és a vendéglátás területén.

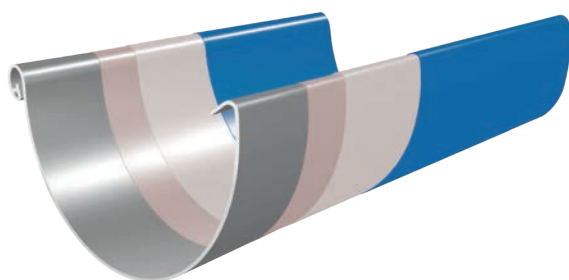

MARCEGAGLIA



A Marcegaglia Olaszország vezető ipari csoportja és az acélgártás legnagyobb független globális szereplője. A maga évente feldolgozott 5,6 millió tonnájával és a több mint 5 milliárd EUR forgalmával (2017) a Marcegaglia ipari csoport Európa és a világ egyik vezető szereplője az acélgártás területén. A megszerzett vezető szerep a hosszú, határozott és stabil növekedési pálya eredménye, amely Marcegagliát az acélgártás területén a legnagyobb független globális szereplővé teszi.



-  Felső lakkozott réteg (kb. 20 μm) poliészter alapon a kiváló optika és a legnagyobb sérülésállóság érdekében
-  Alapozó réteg (kb. 5 μm) a tökéletes tapadás és erős korrózióvédelem érdekében
-  Horganyzott réteg (225 g/m²) az állandó korrózióvédelem érdekében
-  Optimalizált acélszalag az ereszcatorna rendszerhez OS – KJG

CSATORNA KÖRSZELVÉNYU [s=0,55]

P-PZ

Névleges méret	200	200	200
Hossz m	2,0	3,0	4,0
Ár HUF/m	Áfával	Áfával	Áfával
TM 1 Barna RAL 8028	3 077,00 043610	3 077,00 043627	3 077,00 043634
AN 2 Antracit RAL 7016	3 077,00 042187	3 077,00 042194	3 077,00 042200
IC 3 Fekete RAL 9005	3 077,00 042545	3 077,00 042552	3 077,00 042569
OC 4 Bordó RAL 3009		3 077,00 043191	3 077,00 043207
MH 5 Cserépszín RAL 8004		3 122,00 042750	
SB 6 Törtfehér RAL 9002		3 122,00 043498	
BH 7 Világos ezüst RAL 9006		3 122,00 042392	3 122,00 042408
PS 8 Galambszürke RAL 7037		3 122,00 043375	3 122,00 043382
MM 9 Réz barna RAL extra		3 321,00 042927	
BHT – P.20 10 Sötét ezüst RAL 9007			
MZ 11 Mohazöld RAL 6005		3 321,00 043085	
MOT 12 Kék RAL 5010		3 321,00 043016 *	
TZ 13 Zöld RAL 6011		3 321,00 043825 *	
Csomagolás m 	10	15	20
Csomagolás m 	800	1 200	1 600

* Gyártás rendelésre

ACÉL
POLYESTER



CSATORNA KÖRSZELVÉNYU [s=0,55]

P-PZ

Névleges méret	250	250	250	250	250
Hossz m	2,0	3,0	4,0	5,0	6,0
Ár HUF/m	Áfával	Áfával	Áfával	Áfával	Áfával
TM 1 Barna RAL 8028	2 745,00	2 679,00	2 679,00	2 679,00	2 679,00
	043641	043658	043665	043672	043689
AN 2 Antracit RAL 7016	2 745,00	2 679,00	2 679,00	2 679,00	2 679,00
	042217	042224	042231	042248	042255
IC 3 Fekete RAL 9005	2 745,00	2 679,00	2 679,00	2 679,00	2 679,00
	042576	042583	042590	042606	042613
OC 4 Bordó RAL 3009	2 745,00	2 679,00	2 679,00	2 679,00	2 679,00
	043214	043221	043238	043245	043252
MH 5 Cserépszín RAL 8004	2 790,00	2 723,00	2 723,00	2 723,00	2 723,00
	042774	042781	042798	042804	042811
SB 6 Törtfehér RAL 9002		2 723,00	2 723,00		2 723,00
		043504	043511		043528
BH 7 Világos ezüst RAL 9006		2 723,00	2 723,00	2 723,00	2 723,00
		042415	042422	042439	042446
PS 8 Galambszürke RAL 7037			2 723,00		2 723,00
			043399		043405
MM 9 Réz barna RAL extra			2 878,00		2 878,00
			042934		042941
BHT – P.20 10 Sötét ezüst RAL 9007			3 321,00		
			095466		
MZ 11 Mohazöld RAL 6005			2 878,00		2 878,00
			043092		043108
MOT 12 Kék RAL 5010			2 878,00		
			043023		
TZ 13 Zöld RAL 6011			2 878,00		
			043832		
Csomagolás m 	10	15	20	25	30
Csomagolás m 	480	720	960	1 200	1 440



CSATORNA KÖRSZELVÉNYU [s=0,55]

P-PZ

Névleges méret	280	280	280	280	280
Hossz m	2,0	3,0	4,0	5,0	6,0
Ár HUF/m	Áfával	Áfával	Áfával	Áfával	Áfával
TM 1 Barna RAL 8028	3 100,00	3 033,00	3 033,00	3 033,00	3 033,00
	043696	043702	043719	043726	043733
AN 2 Antracit RAL 7016	3 100,00	3 033,00	3 033,00	3 033,00	3 033,00
	042262	042279	042286	042293	042309
IC 3 Fekete RAL 9005	3 100,00	3 033,00	3 033,00	3 033,00	3 033,00
	042620	042637	042644	042651	042668
OC 4 Bordó RAL 3009		3 033,00	3 033,00	3 033,00	3 033,00
		043269	043276	043283	043290
MH 5 Cserépszín RAL 8004		3 077,00	3 077,00		3 077,00
		042828	042835		042842
SB 6 Törtfehér RAL 9002			3 077,00		3 077,00
			043535		043542
BH 7 Világos ezüst RAL 9006		3 077,00	3 077,00		3 077,00
		042453	042460		042477
PS 8 Galambszürke RAL 7037			3 077,00		3 077,00
			043412		043429
MM 9 Réz barna RAL extra			3 299,00		3 299,00
			042958		042965
BHT – P.20 10 Sötét ezüst RAL 9007			3 720,00		
			095473		
MZ 11 Mohazöld RAL 6005			3 299,00		3 299,00
			043115		043122
MOT 12 Kék RAL 5010			3 299,00		
			043030		
TZ 13 Zöld RAL 6011			3 299,00		
			043849		
Csomagolás m 	10	15	20	25	30
Csomagolás m 	420	630	840	1 050	1 260

ACÉL
POLYESTER



CSATORNA KÖRSZELVÉNYU [s=0,55]

P-PZ

Névleges méret	333	333	333	333	333
Hossz m	2,0	3,0	4,0	5,0	6,0
Ár HUF/m	Áfával	Áfával	Áfával	Áfával	Áfával
TM 1 Barna RAL 8028	3 232,00	3 144,00	3 144,00	3 144,00	3 144,00
	043740	043757	043764	043771	043788
AN 2 Antracit RAL 7016	3 232,00	3 144,00	3 144,00	3 144,00	3 144,00
	042316	042323	042330	042347	042354
IC 3 Fekete RAL 9005	3 232,00	3 144,00	3 144,00	3 144,00	3 144,00
	042675	042682	042699	042705	042712
OC 4 Bordó RAL 3009	3 232,00	3 144,00	3 144,00	3 144,00	3 144,00
	043306	043313	043320	043337	043344
MH 5 Cserépszín RAL 8004	3 277,00	3 188,00	3 188,00	3 188,00	3 188,00
	042859	042866	042873	042880	042897
SB 6 Törtfehér RAL 9002		3 188,00	3 188,00	3 188,00	3 188,00
		043559	043566	043573	043580
BH 7 Világos ezüst RAL 9006		3 188,00	3 188,00	3 188,00	3 188,00
		042484	042491	042507	042514
PS 8 Galambszürke RAL 7037		3 188,00	3 188,00	3 188,00	3 188,00
		043436	043443	043450	043467
MM 9 Réz barna RAL extra			3 675,00	3 675,00	3 675,00
			042972	042989	042996
BHT – P.20 10 Sötét ezüst RAL 9007			3 764,00		3 764,00
			095480		095497
MZ 11 Mohazöld RAL 6005			3 675,00	3 675,00	3 675,00
			043139	043146	043153
MOT 12 Kék RAL 5010			3 675,00		3 675,00
			043047		043054
TZ 13 Zöld RAL 6011			3 675,00		
			043856		
Csomagolás m	10	15	20	25	30
Csomagolás m	330	495	660	825	990



CSATORNA KÖRSZELVÉNYU [s=0,55]

P-PZ

Névleges méret	400	400	500	500	333
Hossz m	4,0	6,0	4,0	6,0	7,0
Ár HUF/m	Áfával	Áfával	Áfával	Áfával	Áfával
TM 1 Barna RAL 8028	5 070,00	5 070,00			3 144,00
	043801	043818			043795 *
AN 2 Antracit RAL 7016	5 070,00	5 070,00	6 863,00	6 863,00	
	042361	042378	086730 *	086747 *	
IC 3 Fekete RAL 9005	5 070,00	5 070,00			
	042729	042736			
OC 4 Bordó RAL 3009	5 070,00	5 070,00			
	043351	043368			
MH 5 Cserépszín RAL 8004	5 114,00	5 114,00			
	042903	042910			
SB 6 Törtfehér RAL 9002	5 114,00	5 114,00	6 908,00	6 908,00	
	043597	043603	086778 *	086785 *	
BH 7 Világos ezüst RAL 9006	5 114,00	5 114,00	6 908,00	6 908,00	
	042521	042538	086754 *	086761 *	
PS 8 Galambszürke RAL 7037	5 114,00	5 114,00			
	043474	043481			
MM 9 Réz barna RAL extra	5 380,00				
	043009				
BHT – P.20 10 Sötét ezüst RAL 9007		5 668,00			
		095503			
MZ 11 Mohazöld RAL 6005	5 380,00	5 380,00			
	043160	043177 *			
MOT 12 Kék RAL 5010	5 380,00	5 380,00			
	043061	043078			
TZ 13 Zöld RAL 6011	5 380,00				
	043863 *				
Csomagolás m 	20	30	20	30	35
Csomagolás m 	540	810	–	–	1 155

* Gyártás rendelésre



ACÉL
POLYESTER

FEKVÖERESZ [s=0,55]
P-PZS

Névleges méret	650	650
Hossz m	4,0	6,0
Ár HUF/m	Áfával	Áfával
TM 1 Barna RAL 8028	9 742,00 049926	9 742,00 049933
AN 2 Antracit RAL 7016	9 742,00 049759	9 742,00 049766
IC 3 Fekete RAL 9005	9 742,00 049797	9 742,00 049803
OC 4 Bordó RAL 3009	9 742,00 049865	9 742,00 049872
MH 5 Cserépszín RAL 8004	10 096,00 049810	10 096,00 049827
SB 6 Törtfehér RAL 9002	10 096,00 049902	
BH 7 Világos ezüst RAL 9006	10 096,00 049773	10 096,00 049780
PS 8 Galambszürke RAL 7037	10 096,00 049889	
MM 9 Réz barna RAL extra	11 159,00 049834	
BHT – P.20 10 Sötét ezüst RAL 9007	12 952,00 095749 *	
MZ 11 Mohazöld RAL 6005	11 159,00 049858	
MOT 12 Kék RAL 5010	11 159,00 049841 *	
TZ 13 Zöld RAL 6011	11 159,00 049940 *	
Csomagolás m 	4	6
Csomagolás m 	200	300

* Gyártás rendelésre



DILATÁCIÓS BETÉT

P-PZDI

Névleges méret	250/260	280/260	333/260	400/260
Ár HUF/db	Áfával	Áfával	Áfával	Áfával
TM 1 Barna RAL 8028	6 465,00 013064	6 863,00 013071	7 483,00 013088	8 812,00 013095
AN 2 Antracit RAL 7016	6 465,00 012661	6 863,00 012678	7 483,00 012685	8 812,00 012692
IC 3 Fekete RAL 9005	6 465,00 012746 *	6 863,00 012753 *	7 483,00 012760	8 812,00 012777 *
OC 4 Bordó RAL 3009	6 465,00 012944 *	6 863,00 012951 *	7 483,00 012968 *	8 812,00 012975 *
MH 5 Cserépszín RAL 8004	6 465,00 012784 *	6 863,00 012791 *	7 483,00 012807 *	8 812,00 012814 *
SB 6 Törtfehér RAL 9002	6 465,00 013026 *	6 863,00 013033 *	7 483,00 013040 *	8 812,00 013057 *
BH 7 Világos ezüst RAL 9006	6 465,00 012708 *	6 863,00 012715 *	7 483,00 012722 *	8 812,00 012739 *
PS 8 Galambszürke RAL 7037	6 465,00 012982 *	6 863,00 012999 *	7 483,00 013002 *	8 812,00 013019 *
MM 9 Réz barna RAL extra	6 465,00 012821 *	6 863,00 012838 *	7 483,00 012845 *	8 812,00 012852 *
BHT – P.20 10 Sötét ezüst RAL 9007	6 465,00 096098 *	6 863,00 096104 *	7 483,00 096111 *	8 812,00 114044 *
MZ 11 Mohazöld RAL 6005	6 465,00 012906 *	6 863,00 012913 *	7 483,00 012920 *	8 812,00 012937 *
MOT 12 Kék RAL 5010	6 465,00 012869 *	6 863,00 012876 *	7 483,00 012883 *	8 812,00 012890 *
TZ 13 Zöld RAL 6011	6 465,00 013101 *	6 863,00 013118 *	7 483,00 013125 *	8 812,00 013132 *
Csomagolás db	3	3	5	5
Csomagolás db	360	360	200	200

* Gyártás rendelésre

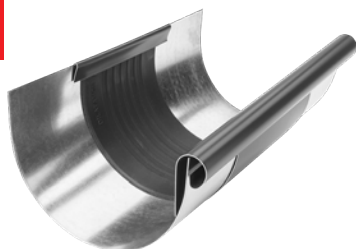

FEKVÖERESZ DILATÁCIO

P-PZSDI



Névleges méret	670/260
Ár HUF/db	Áfával
TM 1 Barna RAL 8028	13 948,00 013637 *
AN 2 Antracit RAL 7016	13 948,00 013545 *
IC 3 Fekete RAL 9005	13 948,00 013569 *
OC 4 Bordó RAL 3009	13 948,00 013606 *
MH 5 Cserépszín RAL 8004	13 948,00 013576 *
SB 6 Törtfehér RAL 9002	13 948,00 013620 *
BH 7 Világos ezüst RAL 9006	13 948,00 013552 *
PS 8 Galambszürke RAL 7037	13 948,00 013613 *
MM 9 Réz barna RAL extra	13 948,00 013583 *
BHT – P.20 10 Sötét ezüst RAL 9007	13 948,00 096067 *
MZ 11 Mohazöld RAL 6005	13 948,00 013651 *
MOT 12 Kék RAL 5010	13 948,00 013590 *
TZ 13 Zöld RAL 6011	13 948,00 013644 *
Csomagolás db	1
Csomagolás db	40

* Gyártás rendelésre

DILATÁCIO

P-PZDIP



Névleges méret	Hossz m	EAN szám	Csomagolás m		Ár áfával [HUF/m]
260	3,0	012470	3	120	14 878,00
260	6,0	012487	6	240	14 878,00

A DILATÁCIÓS ERESZCSATORNA ÉS SZALAG HASZNÁLATA

DILATÁCIÓS ERESZCSATORNA

Szerelési példa: Független, ereszcatorna 500 mm kiterített szélességig.
A dilatációs ereszcatornát 15 m-es közböben kell felszerelni. A külső szögletre és az ereszcatorna elejére elég a normál érték fele: legfeljebb 7,5 m. A belső szögletre a normál érték negyede felel meg: legfeljebb 3,75 m. Egyéb anyagokra és méretekre vonatkozóan: lásd az alábbi táblázatot. A szögletek mindig szilárd pontokként számítandók.

DILATÁCIÓS SZALAG

Belső beépítés: az alapra ragasztás nélkül rögzített ereszcatornák, nem szokványos profilú és lemezborítású falazattal ellátott tetők

ETŐERESZEK FÉLKÖRÍVES DILATÁCIÓS ERESZCSATORNÁK

Ereszcatorna kiterített szélessége	Alumínium	Acél, Titán-cink, Réz, Rozsdamentes acél
< 500	12	15
> 500	8	10

TETŐERESZ DILATÁCIÓS SZALAG

Ereszcatorna kiterített szélessége	Alumínium	Acél, Titán-cink, Réz, Rozsdamentes acél
< 500	8	10
> 500	6	8

A külső szögletre vagy az ereszcatorna elejére elég a normál érték fele. A belső szögletre a normál érték egynegyede érvényes.

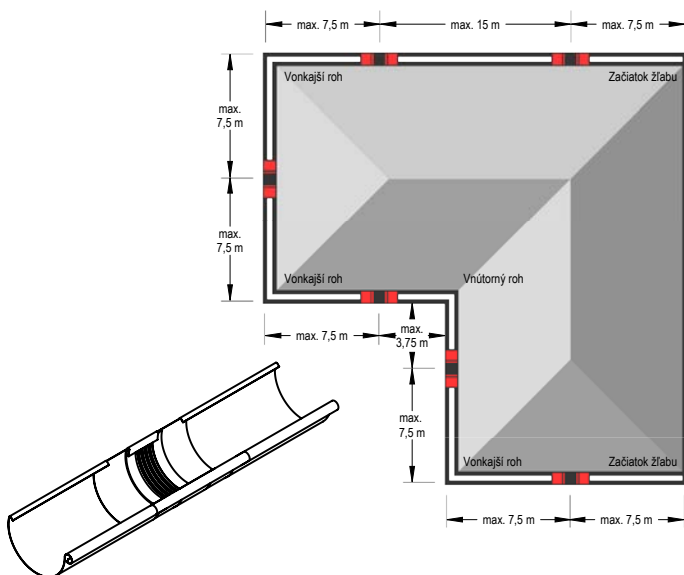

Megjegyzés a dilatációs ereszcatorna szereléséhez.

A forrasztás segítségével végzett szerelésnél először a középső gumi alkatrészt kell vizes ronggyal letakarni (hogy a meleg ne terjedjen át a középső gumi alkatrészbe). Be kell tartani a középső gumi alkatrésztől mért 6 cm legkisebb távolságot. Minden esetben kerülni kell a gumi nyílt lánggal való érintkezését.

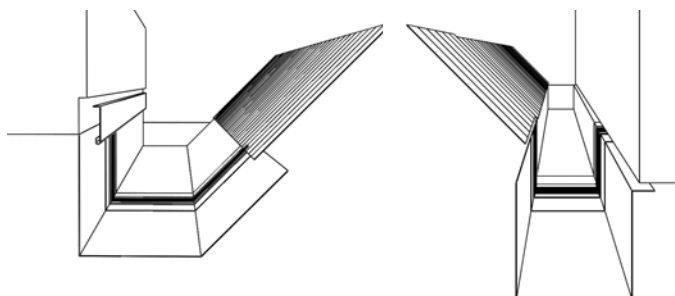

Megjegyzés a dilatációs szalag alkalmazásához.

A dilatációs szalag hajlításánál, szerelésénél győződjön meg arról, hogy:

- A hajlító-pofák rádiusza legalább 2 mm.
- A bádoglemez 1 mm vastagságától be kell tartani a hajlítási sugár 5 mm-es legkisebb értékét.
- A hajlító pofákat a hajlítás során a nyíróhatás - a gumi megrongálásának a megelőzése - céljából a középső gumi alkatrész 3 - 4 mm-es vastagságára kell beállítani.
- A középső gumi elem a hajlítás során nem lehet összenyomva, vagy megrongálva. Ezért egy 2-5 mm (vastag), úgy meghajlított alumínium bádoglemezt kellene alkalmazni, hogy az a hajlító pofák védőelemeként lehessen rögzítve. Így nagyobb hajlítási sugár érhető el megakadályozva a középső gumirész sérülését.

ALUMÍNIUM LOMBRÁCS

P-PZNLMM

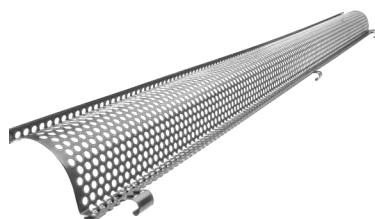





Névleges méret		333
Hossz m		2,0
Ár HUF/db		Áfával
TM Barna RAL 8028	1	11 734,00 064943
AN Antracit RAL 7016	2	11 734,00 064912
IC Fekete RAL 9005	3	11 734,00 064929 *
OC Bordó RAL 3009	4	11 734,00 064936 *
MH Cserépszín RAL 8004	5	11 734,00 119766 *
SB Törtfehér RAL 9002	6	11 734,00 117762 *
BH Világos ezüst RAL 9006	7	11 734,00 117717 *
PS Galambszürke RAL 7037	8	11 734,00 117755 *
MM Réz barna RAL extra	9	11 734,00 117724 *
BHT – P.20 Sötét ezüst RAL 9007	10	11 734,00 097156 *
MZ Mohazöld RAL 6005	11	11 734,00 117748 *
MOT Kék RAL 5010	12	11 734,00 117731 *
TZ Zöld RAL 6011	13	11 734,00 117779 *
Csomagolás db		15
Csomagolás db		120

* Gyártás rendelésre

ACÉL POLYESTER



PVC LOMBRÁCS

SD-ZNL MREZKA

Névleges méret	Hossz m	EAN szám	Csomagolás db		Ár áfával [HUF/db]
					
 171	1,0	008473	30	450	1 990,00
 171	1,0	008466	30	450	1 990,00

PVC LOMBRÁCS

SD-ZNL N

Névleges méret	Hossz m	EAN szám	Csomagolás db		Ár áfával [HUF/db]
					
250	3,0	008480	10	400	10 580,00
280-333	3,0	008497	10	400	10 630,00

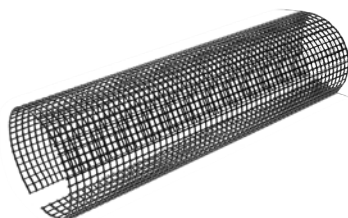
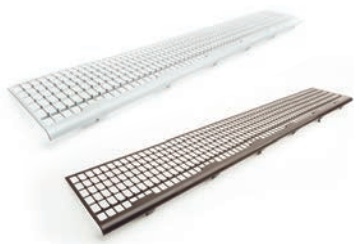

ERESZCSATORNA BIZTOSÍTÓ TARTÓELEM

P-PDZNV

Névleges méret	250-280	333	400
Rozmer v mm	18	20	22
Ár HUF/db	Áfával	Áfával	Áfával
TM 1 Barna RAL 8028	708,00 085665	708,00 085672	708,00 085689 *
AN 2 Antracit RAL 7016	708,00 085290	708,00 085306	708,00 085313
IC 3 Fekete RAL 9005	708,00 085351	708,00 085368	708,00 085375 *
OC 4 Bordó RAL 3009	708,00 085504	708,00 085573	708,00 085597 *
MH 5 Cserépszín RAL 8004	708,00 085382	708,00 085399	708,00 085405 *
SB 6 Törtfehér RAL 9002	708,00 085634 *	708,00 085641	708,00 085658 *
BH 7 Világos ezüst RAL 9006	708,00 085320	708,00 085337	708,00 085344 *
PS 8 Galambszürke RAL 7037	708,00 085603	708,00 085610	708,00 085627 *
MM 9 Réz barna RAL extra	708,00 085412 *	708,00 085429	708,00 085436 *
BHT – P.20 10 Sötét ezüst RAL 9007	708,00 094636 *	708,00 094643 *	708,00 094650 *
MZ 11 Mohazöld RAL 6005	708,00 085474 *	708,00 085481 *	708,00 085498 *
MOT 12 Kék RAL 5010	708,00 085443 *	708,00 085450 *	708,00 085467 *
TZ 13 Zöld RAL 6011	708,00 085696 *	708,00 085702 *	708,00 085719 *
Csomagolás db	25	25	25
Csomagolás db	3 000	3 000	3 000

* Gyártás rendelésre



TOLDÓ

P-PSPZ

Névleges méret	250	280	333
Ár HUF/db	Áfával	Áfával	Áfával
TM 1 Barna RAL 8028	1 683,00 083852	1 683,00 083869	1 771,00 083876
AN 2 Antracit RAL 7016	1 683,00 083456	1 683,00 083463	1 771,00 083470
IC 3 Fekete RAL 9005	1 683,00 083531	1 683,00 083548	1 771,00 083555
OC 4 Bordó RAL 3009	1 683,00 083739	1 683,00 083746	1 771,00 083753
MH 5 Cserépszín RAL 8004	1 683,00 083579	1 683,00 083586	1 771,00 083593
SB 6 Törtfehér RAL 9002	1 683,00 083814	1 683,00 083821	1 771,00 083838
BH 7 Világos ezüst RAL 9006	1 683,00 083494	1 683,00 083500	1 771,00 083517
PS 8 Galambszürke RAL 7037	1 683,00 083777	1 683,00 083784	1 771,00 083791
MM 9 Réz barna RAL extra	1 683,00 083616	1 683,00 083623	1 771,00 083630
BHT – P.20 10 Sötét ezüst RAL 9007	1 683,00 094681	1 683,00 094698 *	1 771,00 094704
MZ 11 Mohazöld RAL 6005	1 683,00 083692	1 683,00 083708	1 771,00 083715
MOT 12 Kék RAL 5010	1 683,00 083654	1 683,00 083661	1 771,00 083678
TZ 13 Zöld RAL 6011	1 683,00 083890 *	1 683,00 083906 *	1 771,00 083913
Csomagolás db	5	5	5
Csomagolás db	600	600	600

* Gyártás rendelésre



CSATORNATARTÓ RÉGI TÍPUS

P-PHP

Névleges méret	200/380	250/430	280/480	280/480
Anyag	25/4	25/5	25/5	30/5
Ár HUF/db	Áfával	Áfával	Áfával	Áfával
TM 1 Barna RAL 8028	1 461,00 045362	1 306,00 045379	1 395,00 045386	1 528,00 045393
AN 2 Antracit RAL 7016	1 461,00 044648	1 306,00 044655	1 395,00 044662	1 528,00 044679
IC 3 Fekete RAL 9005	1 461,00 044808	1 306,00 044815	1 395,00 044822	1 528,00 044839
OC 4 Bordó RAL 3009	1 461,00 045140	1 306,00 045157	1 395,00 045164	1 528,00 045171
MH 5 Cserépszín RAL 8004	1 461,00 044884	1 306,00 044891	1 395,00 044907	1 528,00 044914
SB 6 Törtfehér RAL 9002	1 461,00 045287	1 306,00 045294	1 395,00 045300	1 528,00 045317
BH 7 Világos ezüst RAL 9006	1 461,00 044723	1 306,00 044730	1 395,00 044747	1 528,00 044754
PS 8 Galambszürke RAL 7037	1 461,00 045225	1 306,00 045232		1 528,00 045249
MM 9 Réz barna RAL extra	1 461,00 044969	1 306,00 044976		1 528,00 044983
BHT – P.20 10 Sötét ezüst RAL 9007		1 306,00 095961		1 528,00 095978
MZ 11 Mohazöld RAL 6005	1 461,00 045089	1 306,00 045096		1 528,00 045102
MOT 12 Kék RAL 5010	1 461,00 045027	1 306,00 045034		1 528,00 045041
TZ 13 Zöld RAL 6011	1 461,00 045454 *	1 306,00 045461		1 528,00 045478
Csomagolás db 	25	25	25	25
Csomagolás db 	1 000	1 000	1 000	1 000

* Gyártás rendelésre



CSATORNATARTÓ RÉGI TÍPUS

P-PHP



Névleges méret	333/550	333/550	333/550	333/610	400/610
Anyag	25/5	30/4	30/5	30/5	30/6
Ár HUF/db	Áfával	Áfával	Áfával	Áfával	Áfával
TM 1 Barna RAL 8028	1 395,00	1 461,00	1 550,00	1 815,00	2 613,00
	045409	045416 *	045423	045430	045447
AN 2 Antracit RAL 7016	1 395,00	1 461,00	1 550,00	1 815,00	2 613,00
	044686	080127 *	044693	044709	044716
IC 3 Fekete RAL 9005	1 395,00		1 550,00	1 815,00	2 613,00
	044846		044853	044860	044877
OC 4 Bordó RAL 3009	1 395,00		1 550,00	1 815,00	2 613,00
	045188		045195	045201	045218
MH 5 Cserépszín RAL 8004	1 395,00		1 550,00	1 815,00	2 613,00
	044921		044938	044945	044952
SB 6 Törtfehér RAL 9002	1 395,00		1 550,00	1 815,00	2 613,00
	045324		045331	045348	045355
BH 7 Világos ezüst RAL 9006	1 395,00		1 550,00	1 815,00	2 613,00
	044761		044778	044785	044792
PS 8 Galambszürke RAL 7037			1 550,00	1 815,00	2 613,00
			045256	045263	045270
MM 9 Réz barna RAL extra			1 550,00	1 815,00	2 613,00
			044990	045003	045010
BHT – P.20 10 Sötét ezüst RAL 9007			1 550,00		2 613,00
			095985		095992
MZ 11 Mohazöld RAL 6005			1 550,00	1 815,00	2 613,00
			045119	045126	045133
MOT 12 Kék RAL 5010			1 550,00	1 815,00	2 613,00
			045058	045065	045072
TZ 13 Zöld RAL 6011			1 550,00	1 815,00	2 613,00
			045485	045492	045508 *
Csomagolás db	25	25	25	25	25
Csomagolás db	1 000	1 000	1 000	1 000	500

* Gyártás rendelésre



CSATORNATARTÓ ORRAL MEREVÍTÉSSEL

P-PHPN

Névleges méret	250/430	280/480	333/550
Anyag	25/5	25/5	25/5
Ár HUF/db	Áfával	Áfával	Áfával
TM 1 Bama RAL 8028	1 284,00 095930	1 284,00 095947	1 417,00 095954
AN 2 Antracit RAL 7016	1 284,00 095824	1 284,00 095831	1 417,00 095848
IC 3 Fekete RAL 9005		1 284,00 095879	1 417,00 095886 *
MH 5 Cserépszín RAL 8004		1 284,00 095893	1 417,00 095909
SB 6 Törtfehér RAL 9002		1 284,00 095916	1 417,00 095923 *
BH 7 Világos ezüst RAL 9006		1 284,00 095855	1 417,00 095862
PS 8 Galambszürke RAL 7037			1 417,00 117496 *
Csomagolás db 	25	25	25
Csomagolás db 	1 000	1 000	1 000

* Gyártás rendelésre

CSATORNATARTÓ SZÁRNÉLKÜLI ORRAL

P-PHPNK

Névleges méret	250	280	333
Anyag	25/4	25/4	25/5
Ár HUF/db	Áfával	Áfával	Áfával
TM 1 Bama RAL 8028	1 395,00 095435	1 483,00 095442	1 572,00 095459
AN 2 Antracit RAL 7016	1 395,00 095312	1 483,00 095329	1 572,00 095336
IC 3 Fekete RAL 9005	1 395,00 095374	1 483,00 095381	1 572,00 095398
MH 5 Cserépszín RAL 8004	1 395,00 095404	1 483,00 095411	1 572,00 095428
BH 7 Világos ezüst RAL 9006	1 395,00 095343 *	1 483,00 095350	1 572,00 095367
Csomagolás db 	25	25	25
Csomagolás db 	1 000	1 000	1 000

* Gyártás rendelésre



CSATORNATARTÓ FEKVÓERESZ

P-PHSSN

Névleges méret	4
Anyag	20/6
Ár HUF/db	Áfával
TM 1 Barna RAL 8028	3 808,00 033567
AN 2 Antracit RAL 7016	3 808,00 033468
IC 3 Fekete RAL 9005	3 808,00 033482
OC 4 Bordó RAL 3009	3 808,00 033536
MH 5 Cserépszín RAL 8004	3 808,00 033499
SB 6 Törtfehér RAL 9002	3 808,00 033550
BH 7 Világos ezüst RAL 9006	3 808,00 033475
PS 8 Galambszürke RAL 7037	3 808,00 033543
MM 9 Réz barna RAL extra	3 808,00 033505
BHT – P.20 10 Sötét ezüst RAL 9007	3 808,00 095510 *
MZ 11 Mohazöld RAL 6005	3 808,00 033529
MOT 12 Kék RAL 5010	3 808,00 033512 *
TZ 13 Zöld RAL 6011	3 808,00 033574
Csomagolás db	25
Csomagolás db	1 000

* Gyártás rendelésre

ACÉL
POLYESTER



CSATORNATARTÓ SZÁRNÉLKÜLI

P-PHPK



Névleges méret	200	250	280	333	400
Anyag	25/4	25/4	25/4	25/5	30/5
Ár HUF/db	Áfával	Áfával	Áfával	Áfával	Áfával
TM 1 Barna RAL 8028	1 594,00	1 506,00	1 616,00	1 749,00	2 435,00
	065551	065568	065575	065582	065599
AN 2 Antracit RAL 7016	1 594,00	1 506,00	1 616,00	1 749,00	2 435,00
	065056	065063	065070	065087	065094
IC 3 Fekete RAL 9005	1 594,00	1 506,00	1 616,00	1 749,00	2 435,00
	065155	065162	065179	065186	065193 *
OC 4 Bordó RAL 3009	1 594,00	1 506,00	1 616,00	1 749,00	2 435,00
	065407	065414	065421	065438	065445
MH 5 Cserépszín RAL 8004	1 594,00	1 506,00	1 616,00	1 749,00	2 435,00
	065209	065216	065223	065230	065247 *
SB 6 Törtfehér RAL 9002	1 594,00	1 506,00	1 616,00	1 749,00	2 435,00
	065506	065513	065520	065537	065544
BH 7 Világos ezüst RAL 9006	1 594,00	1 506,00	1 616,00	1 749,00	2 435,00
	065100	065117	065124	065131	065148
PS 8 Galambszürke RAL 7037	1 594,00	1 506,00	1 616,00	1 749,00	2 435,00
	065452	065469	065476	065483	065490
MM 9 Réz barna RAL extra	1 594,00	1 506,00	1 616,00	1 749,00	2 435,00
	065254	065261	065278	065285	065292 *
BHT – P.20 10 Sötét ezüst RAL 9007		1 506,00	1 616,00	1 749,00	
		095251	095268	095275	
MZ 11 Mohazöld RAL 6005	1 594,00	1 506,00	1 616,00	1 749,00	2 435,00
	065353	065360	065377	065384	065391 *
MOT 12 Kék RAL 5010	1 594,00	1 506,00	1 616,00	1 749,00	2 435,00
	065308 *	065315	065322	065339	065346
TZ 13 Zöld RAL 6011	1 594,00	1 506,00	1 616,00	1 749,00	2 435,00
	065605 *	065612 *	065629 *	065636 *	065643 *
Csomagolás db	25	25	25	25	20
Csomagolás db	1 000	1 000	1 000	1 000	800

* Gyártás rendelésre

KÜLSŐ SZEGLET

P-PRA

Névleges méret	200	250	280	333	400
Ár HUF/db	Áfával	Áfával	Áfával	Áfával	Áfával
TM 1 Barna RAL 8028	5 269,00 075673	5 181,00 075680	5 225,00 075697	5 269,00 075703	13 240,00 075710
AN 2 Antracit RAL 7016	5 269,00 075178	5 181,00 075185	5 225,00 075192	5 269,00 075208	13 240,00 075215
IC 3 Fekete RAL 9005	5 269,00 075260	5 181,00 075284	5 225,00 075291	5 269,00 075307	13 240,00 075314
OC 4 Bordó RAL 3009	5 269,00 075529	5 181,00 075536	5 225,00 075543	5 269,00 075567	13 240,00 075550
MH 5 Cserépszín RAL 8004	5 269,00 075321	5 181,00 075338	5 225,00 075345	5 269,00 075352	13 240,00 075369
SB 6 Törtfehér RAL 9002	5 269,00 075635	5 181,00 075628	5 225,00 075642	5 269,00 075659	13 240,00 075666
BH 7 Világos ezüst RAL 9006	5 269,00 075222	5 181,00 075239	5 225,00 075246	5 269,00 075253	13 240,00 075277
PS 8 Galambszürke RAL 7037	5 269,00 075574	5 181,00 075581	5 225,00 075598	5 269,00 075604	13 240,00 075611
MM 9 Réz barna RAL extra	5 269,00 075376	5 181,00 075383	5 225,00 075390	5 269,00 075406	13 240,00 075413
BHT – P.20 10 Sötét ezüst RAL 9007		5 181,00 094384	5 225,00 094391 *	5 269,00 094407	13 240,00 110695
MZ 11 Mohazöld RAL 6005	5 269,00 075475	5 181,00 075482	5 225,00 075499	5 269,00 075505	13 240,00 075512
MOT 12 Kék RAL 5010	5 269,00 075420	5 181,00 075437	5 225,00 075444	5 269,00 075451	13 240,00 075468
TZ 13 Zöld RAL 6011	5 269,00 075727 *	5 181,00 075734	5 225,00 075741	5 269,00 075758	13 240,00 075765 *
Csomagolás db 📦	5	5	5	5	5
Csomagolás db 🚚	150	150	150	150	150

* Gyártás rendelésre



BELSŐ SZEGLET

P-PRI

Névleges méret	200	250	280	333	400
Ár HUF/db	Áfával	Áfával	Áfával	Áfával	Áfával
TM 1 Barna RAL 8028	5 269,00 076281	5 181,00 076274	5 225,00 076298	5 269,00 076304	13 240,00 076311
AN 2 Antracit RAL 7016	5 269,00 075772	5 181,00 075789	5 225,00 075796	5 269,00 075802	13 240,00 075819
IC 3 Fekete RAL 9005	5 269,00 075871	5 181,00 075888	5 225,00 075895	5 269,00 075901	13 240,00 075918
OC 4 Bordó RAL 3009	5 269,00 076120	5 181,00 076137	5 225,00 076144	5 269,00 076168	13 240,00 076151
MH 5 Cserépszín RAL 8004	5 269,00 075925	5 181,00 075932	5 225,00 075949	5 269,00 075956	13 240,00 075963
SB 6 Törtfehér RAL 9002	5 269,00 076229	5 181,00 076236	5 225,00 076243	5 269,00 076250	13 240,00 076267
BH 7 Világos ezüst RAL 9006	5 269,00 075826	5 181,00 075833	5 225,00 075840	5 269,00 075857	13 240,00 075864
PS 8 Galambszürke RAL 7037	5 269,00 076175	5 181,00 076199	5 225,00 076182	5 269,00 076205	13 240,00 076212
MM 9 Réz barna RAL extra	5 269,00 075970	5 181,00 075987	5 225,00 075994	5 269,00 076007	13 240,00 076014
BHT – P.20 10 Sötét ezüst RAL 9007		5 181,00 094414	5 225,00 094421 *	5 269,00 094438	13 240,00 110688
MZ 11 Mohazöld RAL 6005	5 269,00 076076	5 181,00 076083	5 225,00 076090	5 269,00 076106	13 240,00 076113
MOT 12 Kék RAL 5010	5 269,00 076021 *	5 181,00 076038	5 225,00 076045	5 269,00 076052	13 240,00 076069
TZ 13 Zöld RAL 6011	5 269,00 076335 *	5 181,00 076328	5 225,00 076342	5 269,00 076359	13 240,00 076366 *
Csomagolás db 	5	5	5	5	5
Csomagolás db 	150	150	150	150	150

* Gyártás rendelésre



VÉGLEMEZ

P-PCL

Névleges méret	200	250	280	333	400
Ár HUF/db	Áfával	Áfával	Áfával	Áfával	Áfával
TM 1 Barna RAL 8028	642,00 003164	576,00 003171	620,00 003188	642,00 003195	996,00 003201
AN 2 Antracit RAL 7016	642,00 002662	576,00 002679	620,00 002686	642,00 002693	996,00 002709
IC 3 Fekete RAL 9005	642,00 002761	576,00 002778	620,00 002785	642,00 002792	996,00 002808
OC 4 Bordó RAL 3009	642,00 003010	576,00 003027	620,00 003034	642,00 003041	996,00 003058
MH 5 Cserépszín RAL 8004	642,00 002815	576,00 002822	620,00 002839	642,00 002846	996,00 002853
SB 6 Törtfehér RAL 9002	642,00 003119	576,00 003126	620,00 003133	642,00 003140	996,00 003157
BH 7 Világos ezüst RAL 9006	642,00 002716	576,00 002723	620,00 002730	642,00 002747	996,00 002754
PS 8 Galambszürke RAL 7037	642,00 003065	576,00 003072	620,00 003089	642,00 003096	996,00 003102
MM 9 Réz barna RAL extra	642,00 002860	576,00 002877	620,00 002884	642,00 002891	996,00 002907
BHT – P.20 10 Sötét ezüst RAL 9007		576,00 094568	620,00 094575 *	642,00 094582	996,00 094599
MZ 11 Mohazöld RAL 6005	642,00 002969	576,00 002976	620,00 002983	642,00 002990	996,00 003003
MOT 12 Kék RAL 5010	642,00 002914	576,00 002921	620,00 002938	642,00 002945	996,00 002952
TZ 13 Zöld RAL 6011	642,00 003218 *	576,00 003225	620,00 003232	642,00 003249	996,00 003256
Csomagolás db	6/60	6/60	6/60	6/60	4/40
Csomagolás db	1 440	1 440	1 440	1 440	960

* Gyártás rendelésre



VÉGLEMEZ GUMIS

P-PCLG

Névleges méret	250	280	333
Ár HUF/db	Áfával	Áfával	Áfával
TM 1 Barna RAL 8028	1 173,00 004338	1 284,00 004345	1 328,00 004352
AN 2 Antracit RAL 7016	1 173,00 004031	1 284,00 004048	1 328,00 004055
IC 3 Fekete RAL 9005	1 173,00 004093	1 284,00 004109	1 328,00 004116
OC 4 Bordó RAL 3009	1 173,00 004246	1 284,00 004253	1 328,00 004260
MH 5 Cserépszín RAL 8004	1 173,00 004123	1 284,00 004130	1 328,00 004147
SB 6 Törtfehér RAL 9002	1 173,00 004307	1 284,00 004314	1 328,00 004321
BH 7 Világos ezüst RAL 9006	1 173,00 004062	1 284,00 004079	1 328,00 004086
PS 8 Galambszürke RAL 7037	1 173,00 004277	1 284,00 004284	1 328,00 004291
MM 9 Réz barna RAL extra	1 173,00 004154	1 284,00 004161	1 328,00 004178
BHT – P.20 10 Sötét ezüst RAL 9007	1 173,00 094605	1 284,00 094612 *	1 328,00 094629
MZ 11 Mohazöld RAL 6005	1 173,00 004215	1 284,00 004222	1 328,00 004239
MOT 12 Kék RAL 5010	1 173,00 004185	1 284,00 004192	1 328,00 004208
TZ 13 Zöld RAL 6011	1 173,00 004369 *	1 284,00 004376 *	1 328,00 004383 *
Csomagolás db 	4/40	4/40	4/40
Csomagolás db 	960	960	960

* Gyártás rendelésre



BETORKOLLÓCSONK

P-PKL

Névleges méret	200/60	250/60	250/80	280/80	280/100
Ár HUF/db	Áfával	Áfával	Áfával	Áfával	Áfával
TM 1 Barna RAL 8028	3 277,00 067357	3 985,00 067364	2 922,00 067371	2 922,00 067371	3 188,00 067395
AN 2 Antracit RAL 7016	3 277,00 066251	3 985,00 066268	2 922,00 066275	2 922,00 066275	3 188,00 066299
IC 3 Fekete RAL 9005	3 277,00 066473	3 985,00 066480	2 922,00 066497	2 922,00 066497	3 188,00 066510
OC 4 Bordó RAL 3009	3 277,00 067029	3 985,00 067036	2 922,00 067043	2 922,00 067043	3 188,00 067067
MH 5 Cserépszín RAL 8004	3 277,00 066589	3 985,00 066596	2 922,00 066602	2 922,00 066602	3 188,00 066626
SB 6 Törtfehér RAL 9002	3 277,00 067241	3 985,00 067258	2 922,00 067265	2 922,00 067265	3 188,00 067289
BH 7 Világos ezüst RAL 9006	3 277,00 066367	3 985,00 066374	2 922,00 066381	2 922,00 066381	3 188,00 066404
PS 8 Galambszürke RAL 7037	3 277,00 067135	3 985,00 067142 *	2 922,00 067159	2 922,00 067159	3 188,00 067173
MM 9 Réz barna RAL extra	3 277,00 066695	3 985,00 066701 *	2 922,00 066718	2 922,00 066718	3 188,00 066732
BHT – P.20 10 Sötét ezüst RAL 9007	3 277,00 119728 *	3 985,00 119735 *	2 922,00 094469	2 922,00 094469	3 188,00 094483
MZ 11 Mohazöld RAL 6005	3 277,00 066916	3 985,00 066923	2 922,00 066930	2 922,00 066930	3 188,00 066954
MOT 12 Kék RAL 5010	3 277,00 066800 *	3 985,00 066817 *	2 922,00 066824	2 922,00 066824	3 188,00 066848
TZ 13 Zöld RAL 6011	3 277,00 067463 *	3 985,00 067470 *	2 922,00 067487	2 922,00 067487	3 188,00 067500
Csomagolás db 📦	20	20	20	20	20
Csomagolás db 🚚	600	600	600	600	600

* Gyártás rendelésre



ACÉL
POLYESTER

BETORKOLLÓCSONK

P-PKL



Névleges méret	333/80	333/100	333/120
Ár HUF/db	Áfával	Áfával	Áfával
TM 1 Barna RAL 8028	3 720,00 067401	3 520,00 067418	4 207,00 067425
AN 2 Antracit RAL 7016	3 720,00 066305	3 520,00 066312	4 207,00 066329
IC 3 Fekete RAL 9005	3 720,00 066527	3 520,00 066534	4 207,00 066541
OC 4 Bordó RAL 3009	3 720,00 067074	3 520,00 067081	4 207,00 067098
MH 5 Cserépszín RAL 8004	3 720,00 066633	3 520,00 066640	4 207,00 066657
SB 6 Törtfehér RAL 9002	3 720,00 067296	3 520,00 067302	4 207,00 067326
BH 7 Világos ezüst RAL 9006	3 720,00 066411	3 520,00 066428	4 207,00 066435
PS 8 Galambszürke RAL 7037	3 720,00 067180	3 520,00 067197	4 207,00 067203
MM 9 Réz barna RAL extra	3 720,00 066749	3 520,00 066756	4 207,00 066763
BHT – P.20 10 Sötét ezüst RAL 9007	3 720,00 094490 *	3 520,00 094506	4 207,00 094513
MZ 11 Mohazöld RAL 6005	3 720,00 066961	3 520,00 066978	4 207,00 066985
MOT 12 Kék RAL 5010	3 720,00 066855 *	3 520,00 066862	4 207,00 066879
TZ 13 Zöld RAL 6011	3 720,00 067517 *	3 520,00 067524	4 207,00 067531
Csomagolás db 📦	20	20	15
Csomagolás db 🚚	600	600	300

* Gyártás rendelésre

BETORKOLLÓCSONK

P-PKL

Névleges méret	400/100	400/120	400/150
Ár HUF/db	Áfával	Áfával	Áfával
TM 1 Barna RAL 8028	8 413,00 067432	8 413,00 067449	9 520,00 067456
AN 2 Antracit RAL 7016	8 413,00 066336	8 413,00 066343	9 520,00 066350
IC 3 Fekete RAL 9005	8 413,00 066558	8 413,00 066565	9 520,00 066572
OC 4 Bordó RAL 3009	8 413,00 067104 *	8 413,00 067111	9 520,00 067128
MH 5 Cserépszín RAL 8004	8 413,00 066664 *	8 413,00 066671	9 520,00 066688
SB 6 Törtfehér RAL 9002	8 413,00 067319	8 413,00 067333	9 520,00 067340
BH 7 Világos ezüst RAL 9006	8 413,00 066442	8 413,00 066459	9 520,00 066466
PS 8 Galambszürke RAL 7037	8 413,00 067210	8 413,00 067227	9 520,00 067234
MM 9 Réz barna RAL extra	8 413,00 066770 *	8 413,00 066787 *	9 520,00 066794 *
BHT – P.20 10 Sötét ezüst RAL 9007	8 413,00 119742 *	8 413,00 094520	9 520,00 094667
MZ 11 Mohazöld RAL 6005	8 413,00 066992 *	8 413,00 067005	9 520,00 067012
MOT 12 Kék RAL 5010	8 413,00 066886 *	8 413,00 066893	9 520,00 066909
TZ 13 Zöld RAL 6011	8 413,00 067548 *	8 413,00 067555	9 520,00 067562 *
Csomagolás db	15	15	15
Csomagolás db	300	300	300

* Gyártás rendelésre



ACÉL
POLYESTER

KÍNÁLATUNKBAN SZEREPEL EGY ÚJ, FÉDER RÖGZÍTŐ RENDSZERREL RENDELKEZŐ PREMIUM ŐST, AMELY LEHETŐVÉ TESZI A KÖNYÖK IGÉNYELT IRÁNYBA TÖRTÉNŐ KÖNNYŰ ELFORDÍTÁSÁT, ES MINDEN HELYZETBEN MEGBÍZHATÓAN TARTJA HELYZETÉT. BÁRMILYEN KÖNYÖKRE SZEGECSELÉS NÉLKÜL FELSZERELHETŐ.

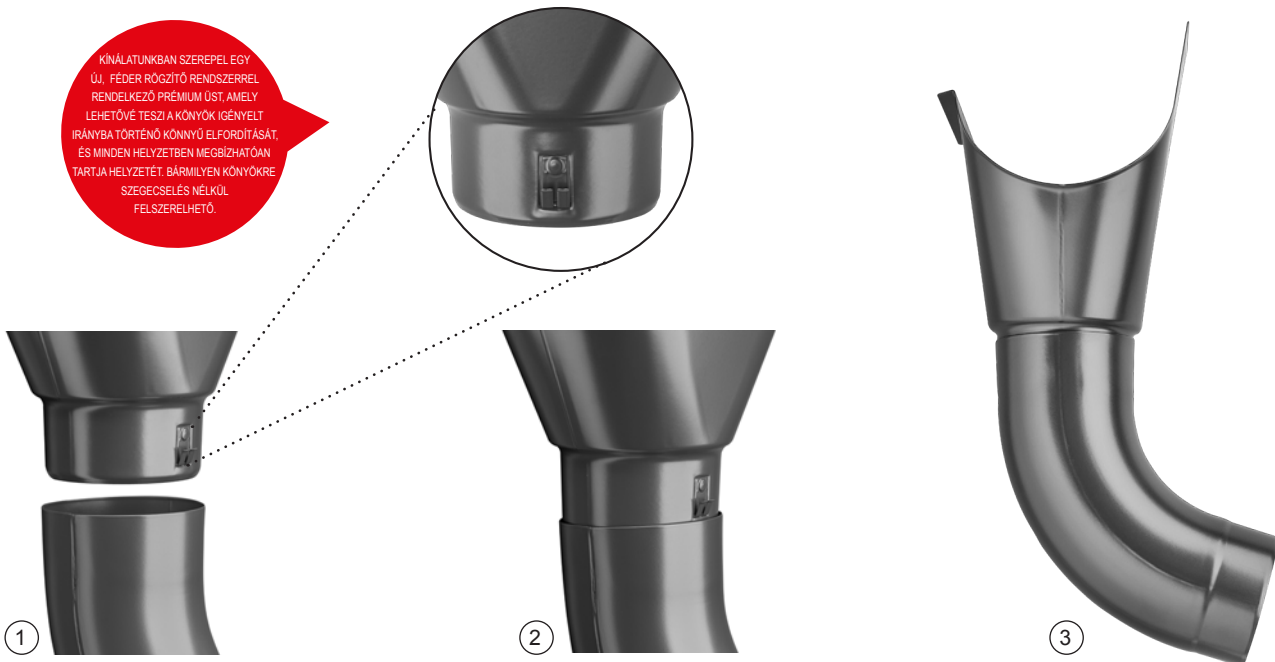

CSONK

P-PHRD

Névleges méret	80	100	120
Ár HUF/db	Áfával	Áfával	Áfával
TM 1 Barna RAL 8028	797,00 066015	841,00 066022	1 018,00 066039
AN 2 Antracit RAL 7016	797,00 065711	841,00 065728	1 018,00 065735 *
IC 3 Fekete RAL 9005	797,00 065773 *	841,00 065780	1 018,00 065797 *
OC 4 Bordó RAL 3009	797,00 065926 *	841,00 065933	1 018,00 065940 *
MH 5 Cserépszín RAL 8004	797,00 065803 *	841,00 065810	1 018,00 065827 *
SB 6 Törtfehér RAL 9002	797,00 065988 *	841,00 065995 *	1 018,00 066008 *
BH 7 Világos ezüst RAL 9006	797,00 065742 *	841,00 065759 *	1 018,00 065766 *
PS 8 Galambszürke RAL 7037	797,00 065957 *	841,00 065964 *	1 018,00 065971 *
MM 9 Réz barna RAL extra	797,00 065834 *	841,00 065841 *	1 018,00 065858 *
BHT – P.20 10 Sötét ezüst RAL 9007			
MZ 11 Mohazöld RAL 6005	797,00 065896 *	841,00 065902 *	1 018,00 065919 *
MOT 12 Kék RAL 5010	797,00 065865 *	841,00 065872 *	1 018,00 065889 *
TZ 13 Zöld RAL 6011	797,00 066046 *	841,00 066053 *	1 018,00 066060 *
Csomagolás db 📦	25	25	15
Csomagolás db 🚚	1 000	1 000	750



* Gyártás rendelésre



ROZSDAMENTES ACÉL LOMBKOSÁR

N-NZN



Névleges méret	EAN szám	Csomagolás db		Ár áfával [HUF/db]
				
60	001153	30	2 160	2 460,00
80	001160	20	1 440	2 480,00
100	001177	15	1 080	2 520,00
120	001184	10	720	2 750,00
150	001191	5	360	4 340,00



VÍZGYÜJTŐ ÜST DESIGN

P-PKLZ DE



Névleges méret	80	100	120
Ár HUF/db	Áfával	Áfával	Áfával
TM 1 Barna RAL 8028	25 682,00 027702	25 682,00 027726	28 339,00 027740
AN 2 Antracit RAL 7016	25 682,00 026200	25 682,00 026224	28 339,00 026248
IC 3 Fekete RAL 9005	25 682,00 026507	25 682,00 026521	28 339,00 026545
OC 4 Bordó RAL 3009	25 682,00 027252 *	25 682,00 027276	28 339,00 027290
MH 5 Cserépszín RAL 8004	25 682,00 026651	25 682,00 026675	28 339,00 026699
SB 6 Törtfehér RAL 9002	25 682,00 027559 *	25 682,00 027573	28 339,00 027597
BH 7 Világos ezüst RAL 9006	25 682,00 026354	25 682,00 026378	28 339,00 026392
PS 8 Galambszürke RAL 7037	25 682,00 027405	25 682,00 027429	28 339,00 027443
MM 9 Réz barna RAL extra	25 682,00 026804 *	25 682,00 026828	28 339,00 026842
BHT – P.20 10 Sötét ezüst RAL 9007	25 682,00 096210	25 682,00 096265	28 339,00 096319
MZ 11 Mohazöld RAL 6005	25 682,00 027108 *	25 682,00 027122	28 339,00 027146 *
MOT 12 Kék RAL 5010	25 682,00 026958 *	25 682,00 026972	28 339,00 027009 *
TZ 13 Zöld RAL 6011	25 682,00 027856 *	25 682,00 027870 *	28 339,00 027894 *
Csomagolás db	2	2	2
Csomagolás db	36	36	36

* Gyártás rendelésre

VÍZGYÜJTŐ ÜST DESIGN EXCENTRIKUS

P-PKLZ DX



Névleges méret	80	100	120
Ár HUF/db	Áfával	Áfával	Áfával
TM 1 Barna RAL 8028	31 882,00 027764	31 882,00 027795	32 767,00 027825
AN 2 Antracit RAL 7016	31 882,00 026262	31 882,00 026293	32 767,00 026323
IC 3 Fekete RAL 9005	31 882,00 026569	31 882,00 026590	32 767,00 026620 *
OC 4 Bordó RAL 3009	31 882,00 027313	31 882,00 027344	32 767,00 027375 *
MH 5 Cserépszín RAL 8004	31 882,00 026712 *	31 882,00 026743 *	32 767,00 026774 *
SB 6 Törtfehér RAL 9002	31 882,00 027610 *	31 882,00 027641	32 767,00 027672
BH 7 Világos ezüst RAL 9006	31 882,00 026415 *	31 882,00 026446	32 767,00 026477
PS 8 Galambszürke RAL 7037	31 882,00 027467 *	31 882,00 027498	32 767,00 027528
MM 9 Réz barna RAL extra	31 882,00 026866 *	31 882,00 026897	32 767,00 026927 *
BHT – P.20 10 Sötét ezüst RAL 9007	31 882,00 096203 *	31 882,00 096258	32 767,00 096302
MZ 11 Mohazöld RAL 6005	31 882,00 027160 *	31 882,00 027191 *	32 767,00 027221 *
MOT 12 Kék RAL 5010	31 882,00 027016 *	31 882,00 027047 *	32 767,00 027078 *
TZ 13 Zöld RAL 6011	31 882,00 027917 *	31 882,00 027948 *	32 767,00 027979 *
Csomagolás db 	2	2	2
Csomagolás db 	36	36	36

* Gyártás rendelésre

VÍZGYÜJTŐ ÜST KÖBÖS

P-PKLZ KU



Névleges méret	80	100	120
Ár HUF/db	Áfával	Áfával	Áfával
TM 1 Barna RAL 8028	38 966,00 027719 *	38 966,00 027733	41 623,00 027757
AN 2 Antracit RAL 7016	38 966,00 026217	38 966,00 026231	41 623,00 026255
IC 3 Fekete RAL 9005	38 966,00 026514	38 966,00 026538	41 623,00 026552
OC 4 Bordó RAL 3009	38 966,00 027269 *	38 966,00 027283 *	41 623,00 027306
MH 5 Cserépszín RAL 8004	38 966,00 026668 *	38 966,00 026682 *	41 623,00 026705 *
SB 6 Törtfehér RAL 9002	38 966,00 027566 *	38 966,00 027580 *	41 623,00 027603 *
BH 7 Világos ezüst RAL 9006	38 966,00 026361 *	38 966,00 026385	41 623,00 026408
PS 8 Galambszürke RAL 7037	38 966,00 027412 *	38 966,00 027436 *	41 623,00 027450
MM 9 Réz barna RAL extra	38 966,00 026811 *	38 966,00 026835 *	41 623,00 026859 *
BHT – P.20 10 Sötét ezüst RAL 9007	38 966,00 096241 *	38 966,00 096296 *	41 623,00 096340 *
MZ 11 Mohazöld RAL 6005	38 966,00 027115 *	38 966,00 027139 *	41 623,00 027153 *
MOT 12 Kék RAL 5010	38 966,00 026965 *	38 966,00 026989 *	41 623,00 026996 *
TZ 13 Zöld RAL 6011	38 966,00 027863 *	38 966,00 027887 *	41 623,00 027900 *
Csomagolás db 	2	2	2
Csomagolás db 	36	36	36

* Gyártás rendelésre

VÍZGYÜJTŐ ÜST KÖBÖS EXCENTRIKUS

P-PKLZ KX



Névleges méret	80	100	120
Ár HUF/db	Áfával	Áfával	Áfával
TM 1 Barna RAL 8028	38 966,00 027788	38 966,00 027818	41 623,00 027849
AN 2 Antracit RAL 7016	38 966,00 026286	38 966,00 026316	41 623,00 026347
IC 3 Fekete RAL 9005	38 966,00 026583	38 966,00 026613	41 623,00 026644 *
OC 4 Bordó RAL 3009	38 966,00 027337 *	38 966,00 027368	41 623,00 027399
MH 5 Cserépszín RAL 8004	38 966,00 026736	38 966,00 026767	41 623,00 026798 *
SB 6 Törtfehér RAL 9002	38 966,00 027634 *	38 966,00 027665	41 623,00 027696
BH 7 Világos ezüst RAL 9006	38 966,00 026439 *	38 966,00 026460	41 623,00 026491
PS 8 Galambszürke RAL 7037	38 966,00 027481 *	38 966,00 027511	41 623,00 027542
MM 9 Réz barna RAL extra	38 966,00 026880 *	38 966,00 026910	41 623,00 026941 *
BHT – P.20 10 Sötét ezüst RAL 9007	38 966,00 096227	38 966,00 096272	41 623,00 096326
MZ 11 Mohazöld RAL 6005	38 966,00 027184 *	38 966,00 027214	41 623,00 027245 *
MOT 12 Kék RAL 5010	38 966,00 027030 *	38 966,00 027061 *	41 623,00 027092 *
TZ 13 Zöld RAL 6011	38 966,00 027931 *	38 966,00 027962	41 623,00 027993 *
Csomagolás db 	2	2	2
Csomagolás db 	36	36	36

* Gyártás rendelésre

VÍZGYÜJTŐ ÜST KÖBÖS KIFOLYÁSSAL EXCENTRIKUS P-PKLZ KXV



Névleges méret	80	100	120
Ár HUF/db	Áfával	Áfával	Áfával
TM 1 Barna RAL 8028	50 922,00 027771 *	50 922,00 027801 *	50 922,00 027832 *
AN 2 Antracit RAL 7016	50 922,00 026279 *	50 922,00 026309 *	50 922,00 026330 *
IC 3 Fekete RAL 9005	50 922,00 026576 *	50 922,00 026606	50 922,00 026637 *
OC 4 Bordó RAL 3009	50 922,00 027320 *	50 922,00 027351 *	50 922,00 027382 *
MH 5 Cserépszín RAL 8004	50 922,00 026729 *	50 922,00 026750 *	50 922,00 026781 *
SB 6 Törtfehér RAL 9002	50 922,00 027627 *	50 922,00 027658 *	50 922,00 027689 *
BH 7 Világos ezüst RAL 9006	50 922,00 026422 *	50 922,00 026453 *	50 922,00 026484 *
PS 8 Galambszürke RAL 7037	50 922,00 027474 *	50 922,00 027504 *	50 922,00 027535 *
MM 9 Réz barna RAL extra	50 922,00 026873 *	50 922,00 026903 *	50 922,00 026934 *
BHT – P.20 10 Sötét ezüst RAL 9007	50 922,00 096234 *	50 922,00 096289 *	50 922,00 096333 *
MZ 11 Mohazöld RAL 6005	50 922,00 027177 *	50 922,00 027207 *	50 922,00 027238 *
MOT 12 Kék RAL 5010	50 922,00 027023 *	50 922,00 027054 *	50 922,00 027085 *
TZ 13 Zöld RAL 6011	50 922,00 027924 *	50 922,00 027955 *	50 922,00 027986 *
Csomagolás db 	2	2	2
Csomagolás db 	36	36	36

* Gyártás rendelésre

TÖMÍTŐ GUMI VÍZGYUJTÓ ŰSTRE

P-PKLZ T



Névleges méret	EAN szám	Csomagolás db		Ár áfával [HUF/db]
IC 70-85	077103	5	600	1 770,00
IC 100-110	077110	5	600	1 820,00
IC 110-125	077097	5	600	1 860,00
PS 70-85	077134	5	600	1 990,00
PS 100-110	077141	5	600	2 170,00
PS 110-125	077127	5	600	2 210,00

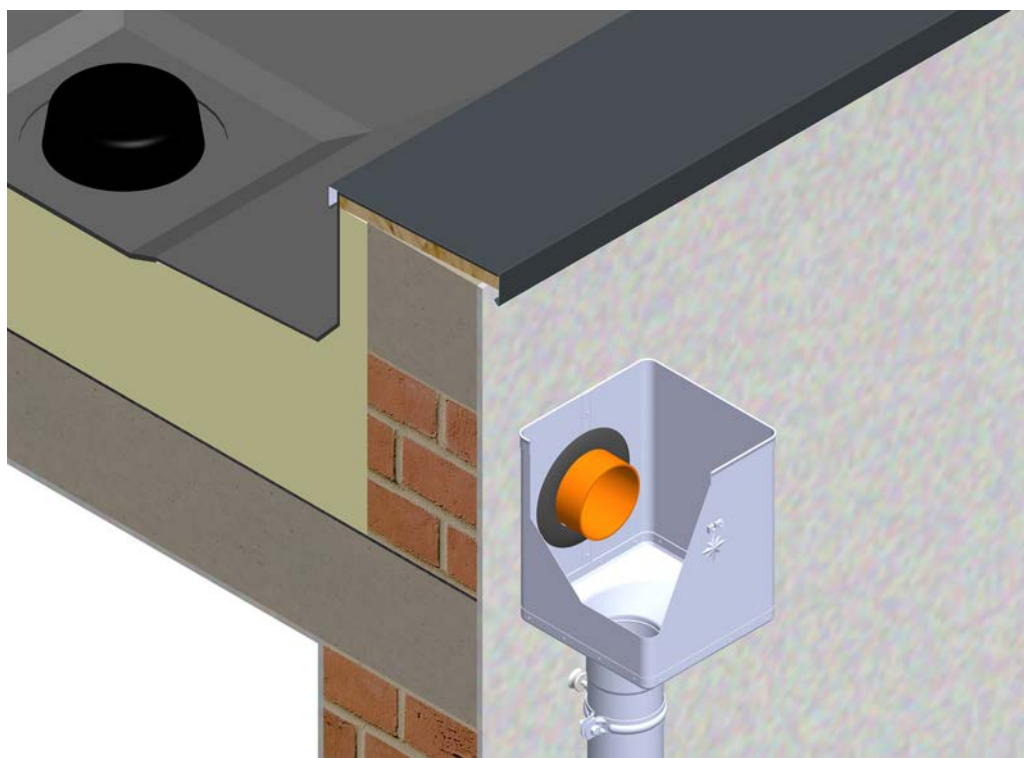

KÖNYÖK 72°

P-PK

Névleges méret	60	80	100	120	150
Ár HUF/db	Áfával	Áfával	Áfával	Áfával	Áfával
TM 1 Barna RAL 8028	2 657,00 072542	2 435,00 072559	2 657,00 072573	3 764,00 072597	8 834,00 033697
AN 2 Antracit RAL 7016	2 657,00 071842	2 435,00 071859	2 657,00 071873	3 764,00 071897	8 834,00 033598
IC 3 Fekete RAL 9005	2 657,00 071989	2 435,00 072023	2 657,00 072009	3 764,00 072030	8 834,00 033611
OC 4 Bordó RAL 3009	2 657,00 072337	2 435,00 072344	2 657,00 072368	3 764,00 072382	8 834,00 033666
MH 5 Cserépszín RAL 8004	2 657,00 072054	2 435,00 072061	2 657,00 072085	3 764,00 072108	8 834,00 033628
SB 6 Törtfehér RAL 9002	2 657,00 072474	2 435,00 072481	2 657,00 072504	3 764,00 072528	8 834,00 033680
BH 7 Világos ezüst RAL 9006	2 657,00 071910	2 435,00 071927	2 657,00 071941	3 764,00 071965	8 834,00 033604
PS 8 Galamszürke RAL 7037	2 657,00 072405	2 435,00 072412	2 657,00 072429	3 764,00 072443	8 834,00 033673
MM 9 Réz barna RAL extra	2 657,00 072122	2 435,00 072139	2 657,00 072153	3 764,00 072160	8 834,00 033635
BHT – P.20 10 Sötét ezüst RAL 9007	2 657,00 118691 *	2 435,00 095183	2 657,00 095206	3 764,00 095220	8 834,00 095244
MZ 11 Mohazöld RAL 6005	2 657,00 072269	2 435,00 072276	2 657,00 072290	3 764,00 072313	8 834,00 033659
MOT 12 Kék RAL 5010	2 657,00 072191	2 435,00 072207	2 657,00 072221	3 764,00 072245	8 834,00 033642
TZ 13 Zöld RAL 6011	2 657,00 072610 *	2 435,00 072627	2 657,00 072641	3 764,00 072665	8 834,00 033703 *
Csomagolás db 📦	25	25	25	15	5
Csomagolás db 🚚	600	400	300	180	90



ACÉL
POLYESTER

* Gyártás rendelésre

KÖNYÖK 85°

P-PKR



Névleges méret	80	100	120
Ár HUF/db	Áfával	Áfával	Áfával
TM 1 Barna RAL 8028	3 055,00 072566	3 454,00 072580	5 491,00 072603
AN 2 Antracit RAL 7016	3 055,00 071866	3 454,00 071880	5 491,00 071903
IC 3 Fekete RAL 9005	3 055,00 071996	3 454,00 072016	5 491,00 072047
OC 4 Bordó RAL 3009	3 055,00 072351	3 454,00 072375	5 491,00 072399
MH 5 Cserépszín RAL 8004	3 055,00 072078	3 454,00 072092	5 491,00 072115
SB 6 Törtfehér RAL 9002	3 055,00 072498	3 454,00 072511	5 491,00 072535
BH 7 Világos ezüst RAL 9006	3 055,00 071934	3 454,00 071958	5 491,00 071972
PS 8 Galambszürke RAL 7037	3 055,00 072467	3 454,00 072436	5 491,00 072450
MM 9 Réz barna RAL extra	3 055,00 072146	3 454,00 072184	5 491,00 072177
BHT – P.20 10 Sötét ezüst RAL 9007	3 055,00 095190	3 454,00 095213	5 491,00 095237 *
MZ 11 Mohazöld RAL 6005	3 055,00 072283	3 454,00 072306	5 491,00 072320
MOT 12 Kék RAL 5010	3 055,00 072214 *	3 454,00 072238 *	5 491,00 072252 *
TZ 13 Zöld RAL 6011	3 321,00 072634 *	3 764,00 072658 *	6 155,00 072672 *
Csomagolás db 	25	25	15
Csomagolás db 	400	300	180

* Gyártás rendelésre

KÖNYÖK 40°

P-PKT

Névleges méret	80	100	120
Ár HUF/db	Áfával	Áfával	Áfával
TM 1 Barna RAL 8028	2 878,00 072993	3 144,00 073006	4 428,00 073013
AN 2 Antracit RAL 7016	2 878,00 072696	3 144,00 072702	4 428,00 072719
IC 3 Fekete RAL 9005	2 878,00 072757	3 144,00 072764	4 428,00 072771
OC 4 Bordó RAL 3009	2 878,00 072900	3 144,00 072917	4 428,00 072924
MH 5 Cserépszín RAL 8004	2 878,00 072795	3 144,00 072788	4 428,00 072801
SB 6 Törtfehér RAL 9002	2 878,00 072962	3 144,00 072979	4 428,00 072986
BH 7 Világos ezüst RAL 9006	2 878,00 072726	3 144,00 072733	4 428,00 072740
PS 8 Galamszürke RAL 7037	2 878,00 072931	3 144,00 072948	4 428,00 072955
MM 9 Réz barna RAL extra	2 878,00 072818	3 144,00 072825	4 428,00 072832 *
BHT – P.20 10 Sötét ezüst RAL 9007	2 878,00 094711	3 144,00 094728	4 428,00 094735
MZ 11 Mohazöld RAL 6005	2 878,00 072870 *	3 144,00 072887	4 428,00 072894
MOT 12 Kék RAL 5010	2 878,00 072849	3 144,00 072856	4 428,00 072863
TZ 13 Zöld RAL 6011	2 878,00 073020 *	3 144,00 073037 *	4 428,00 073044 *
Csomagolás db 	25	25	15
Csomagolás db 	400	300	240

* Gyártás rendelésre



KIMENETI KÖNYÖK 72°

P-PKV



Névleges méret	80	100	120
Ár HUF/db	Áfával	Áfával	Áfával
TM 1 Barna RAL 8028	2 878,00 095046	3 100,00 095053	4 207,00 095060
AN 2 Antracit RAL 7016	2 878,00 094742	3 100,00 094759	4 207,00 094766
IC 3 Fekete RAL 9005	2 878,00 094803	3 100,00 094810	4 207,00 094827 *
OC 4 Bordó RAL 3009	2 878,00 094957 *	3 100,00 094964	4 207,00 094971 *
MH 5 Cserépszín RAL 8004	2 878,00 094834	3 100,00 094841	4 207,00 094858
SB 6 Törtfehér RAL 9002	2 878,00 095015 *	3 100,00 095022	4 207,00 095039
BH 7 Világos ezüst RAL 9006	2 878,00 094773 *	3 100,00 094780	4 207,00 094797
PS 8 Galambszürke RAL 7037	2 878,00 094988 *	3 100,00 094995 *	4 207,00 095008 *
MM 9 Réz barna RAL extra	2 878,00 094865 *	3 100,00 094872 *	4 207,00 094889 *
BHT – P.20 10 Sötét ezüst RAL 9007	2 878,00 124739 *	3 100,00 124746 *	4 207,00 124753 *
MZ 11 Mohazöld RAL 6005	2 878,00 094926 *	3 100,00 094933 *	4 207,00 094940 *
MOT 12 Kék RAL 5010	2 878,00 094896 *	3 100,00 094902 *	4 207,00 094919 *
TZ 13 Zöld RAL 6011	2 878,00 095077 *	3 100,00 095084 *	4 207,00 095091 *
Csomagolás db	25	25	15
Csomagolás db	400	300	180

* Gyártás rendelésre

KONYOK FALCOLT 72°

P-PKF2



Névleges méret	60	80	100	120
Ár HUF/db	Áfával	Áfával	Áfával	Áfával
TM 1	1 904,00	1 506,00	1 948,00	2 790,00
Barna RAL 8028	071781	071798	071811	071828
Csomagolás db	10	10	10	8
Csomagolás db	3 000	1 200	800	576

KONYOK FALCOLT 85°

P-PKF3



Névleges méret	80	100
Ár HUF/db	Áfával	Áfával
TM 1	1 948,00	2 790,00
Barna RAL 8028	071804	071835
Csomagolás db	10	10
Csomagolás db	1 200	800



IDEIGLENES FÓLIACSŐ

SD-ZR FOLIA KJG

Névleges méret	Hossz m	EAN szám	Csomagolás m		Ár áfával [HUF/m]
60-150	100,0	139726	100	6 000	170,00

LEFOLYÓCSŐ [s=0,55]

P-PZR



Névleges méret	60	60	80	80	80
Hossz m	2,0	3,0	1,0	2,0	3,0
Ár HUF/m	Áfával	Áfával	Áfával	Áfával	Áfával
TM 1 Barna RAL 8028	3 542,00	3 542,00	3 188,00	3 188,00	3 100,00
	071309	071316	071323	071330	071347
AN 2 Antracit RAL 7016	3 542,00	3 542,00	3 188,00	3 188,00	3 100,00
	069467	069474	069481	069498	069504
IC 3 Fekete RAL 9005	3 542,00	3 542,00	3 188,00	3 188,00	3 100,00
	069900	069917	069924	069931	069948
OC 4 Bordó RAL 3009	3 542,00	3 542,00	3 188,00	3 188,00	3 100,00
	070661	070678	070685	070692	070708
MH 5 Cserépszín RAL 8004	3 587,00		3 232,00	3 232,00	3 144,00
	070128		070142	070159	070166
SB 6 Törtfehér RAL 9002	3 587,00	3 587,00	3 232,00	3 232,00	3 144,00
	071088	071095	071101	071118	071125
BH 7 Világos ezüst RAL 9006	3 587,00	3 587,00	3 232,00	3 232,00	3 144,00
	069689	069696	069702	069719	069726
PS 8 Galambszürke RAL 7037	3 587,00	3 587,00	3 232,00	3 232,00	3 144,00
	070883	070890	070906	070913	070920
MM 9 Réz barna RAL extra	3 764,00		3 432,00	3 432,00	3 343,00
	070340		070364	070371	070388
BHT – P.20 10 Sötét ezüst RAL 9007					3 786,00
					096128
MZ 11 Mohazöld RAL 6005	3 764,00				3 343,00
	070586				070593
MOT 12 Kék RAL 5010	3 764,00				3 343,00
	070494				070500
TZ 13 Zöld RAL 6011	3 764,00			3 432,00	
	071521 *			071538	
Csomagolás m	10	15	10	10	15
Csomagolás m	490	735	100	250	375

* Gyártás rendelésre

LEFOLYÓCSŐ [s=0,55]

P-PZR

Névleges méret	80	80	80	100	100
Hossz m	4,0	5,0	6,0	1,0	2,0
Ár HUF/m	Áfával	Áfával	Áfával	Áfával	Áfával
TM 1 Barna RAL 8028	3 100,00	3 100,00	3 100,00	3 277,00	3 277,00
	071354	071361 *	071378 *	071385	071392
AN 2 Antracit RAL 7016	3 100,00	3 100,00	3 100,00	3 277,00	3 277,00
	069511	069528 *	069535 *	069542	069559
IC 3 Fekete RAL 9005	3 100,00	3 100,00	3 100,00	3 277,00	3 277,00
	069955	069962 *	069979 *	069986	069993
OC 4 Bordó RAL 3009	3 100,00	3 100,00	3 100,00	3 277,00	3 277,00
	070715	070722 *	070739 *	070746	070753
MH 5 Cserépszín RAL 8004	3 144,00	3 144,00	3 144,00	3 321,00	3 321,00
	070173	070180 *	070197 *	070203	070210
SB 6 Törtfehér RAL 9002	3 144,00	3 144,00	3 144,00	3 321,00	3 321,00
	071132	071149 *	071156 *	071163	071170
BH 7 Világos ezüst RAL 9006	3 144,00	3 144,00	3 144,00	3 321,00	3 321,00
	069733	069740 *	069757 *	069764	069771
PS 8 Galambszürke RAL 7037	3 144,00	3 144,00	3 144,00	3 321,00	3 321,00
	070937	070944 *	070951 *	070968	070975
MM 9 Réz barna RAL extra	3 343,00		3 720,00	3 720,00	4 118,00
	070395		070401	070418	070418
BHT – P.20 10 Sötét ezüst RAL 9007					
MZ 11 Mohazöld RAL 6005	3 343,00				
	070609				
MOT 12 Kék RAL 5010					
TZ 13 Zöld RAL 6011					
Csomagolás m 	20	5	6	10	10
Csomagolás m 	500	625	750	70	160

* Gyártás rendelésre



LEFOLYÓCSŐ [s=0,55]
P-PZR

Névleges méret	100	100	100	100	120
Hossz m	3,0	4,0	5,0	6,0	1,0
Ár HUF/m	Áfával	Áfával	Áfával	Áfával	Áfával
TM 1 Barna RAL 8028	3 188,00 071408	3 188,00 071415	3 188,00 071422	3 188,00 071439 *	4 760,00 071446
AN 2 Antracit RAL 7016	3 188,00 069566	3 188,00 069573	3 188,00 069580	3 188,00 069597 *	4 760,00 069603
IC 3 Fekete RAL 9005	3 188,00 070005	3 188,00 070012	3 188,00 070029	3 188,00 070036 *	4 760,00 070043
OC 4 Bordó RAL 3009	3 188,00 070760	3 188,00 070777	3 188,00 070784 *	3 188,00 070791 *	4 760,00 070807
MH 5 Cserépszín RAL 8004	3 232,00 070227	3 232,00 070234	3 232,00 070241 *	3 232,00 070258 *	4 804,00 070265
SB 6 Törtfehér RAL 9002	3 232,00 071187	3 232,00 071194	3 232,00 071200 *	3 232,00 071217 *	4 804,00 071224
BH 7 Világos ezüst RAL 9006	3 232,00 069788	3 232,00 069795	3 232,00 069801 *	3 232,00 069818 *	4 804,00 069825
PS 8 Galambszürke RAL 7037	3 232,00 070982	3 232,00 070999	3 232,00 071002 *	3 232,00 071019 *	4 804,00 071026
MM 9 Réz barna RAL extra	3 631,00 070425	3 631,00 070432			5 092,00 070449
BHT – P.20 10 Sötét ezüst RAL 9007	3 897,00 096135	3 897,00 096142			
MZ 11 Mohazöld RAL 6005	3 631,00 070616	3 631,00 070623			
MOT 12 Kék RAL 5010	3 631,00 070524	3 631,00 070531			
TZ 13 Zöld RAL 6011	3 631,00 071545	3 631,00 071552			
Csomagolás m	15	20	5	6	8
Csomagolás m	240	320	400	480	480

* Gyártás rendelésre



LEFOLYÓCSŐ [s=0,55]

P-PZR



Névleges méret	120	120	120	120	120
Hossz m	2,0	3,0	4,0	5,0	6,0
Ár HUF/m	Áfával	Áfával	Áfával	Áfával	Áfával
TM 1 Barna RAL 8028	4 760,00	4 672,00	4 672,00	4 672,00	4 672,00
	071453	071460	071477	071484 *	071491 *
AN 2 Antracit RAL 7016	4 760,00	4 672,00	4 672,00	4 672,00	4 672,00
	069610	069627	069634	069641 *	069658 *
IC 3 Fekete RAL 9005	4 760,00	4 672,00	4 672,00	4 672,00	4 672,00
	070050	070067	070074	070081 *	070098 *
OC 4 Bordó RAL 3009	4 760,00	4 672,00	4 672,00	4 672,00	4 672,00
	070814	070821	070838	070845 *	070852 *
MH 5 Cserépszín RAL 8004	4 804,00	4 716,00	4 716,00	4 716,00	4 716,00
	070272	070289	070296	070302 *	070319 *
SB 6 Törtfehér RAL 9002	4 804,00	4 716,00	4 716,00	4 716,00	4 716,00
	071231	071248	071255	071262	071279 *
BH 7 Világos ezüst RAL 9006	4 804,00	4 716,00	4 716,00	4 716,00	4 716,00
	069832	069849	069856	069863	069870 *
PS 8 Galambszürke RAL 7037	4 804,00	4 716,00	4 716,00		
	071033	071040	071057		
MM 9 Réz barna RAL extra	5 092,00	5 026,00	5 026,00		
	070456	070463	070470		
BHT – P.20 10 Sötét ezüst RAL 9007		5 336,00			
		096159			
MZ 11 Mohazöld RAL 6005		5 026,00	5 026,00		
		070630	070647		
MOT 12 Kék RAL 5010		5 026,00	5 026,00		
		070548	070555		
TZ 13 Zöld RAL 6011		5 026,00	5 026,00		
		071569	071576		
Csomagolás m 	10	15	20	5	8
Csomagolás m 	120	180	240	300	48

* Gyártás rendelésre



ACÉL
POLYESTER

LEFOLYÓCSŐ [s=0,55]
P-PZR

Névleges méret	150	150
Hossz m	3,0	4,0
Ár HUF/m	Áfával	Áfával
TM 1 Barna RAL 8028	9 122,00 071507	9 122,00 071514
AN 2 Antracit RAL 7016	9 122,00 069665	9 122,00 069672
IC 3 Fekete RAL 9005		9 122,00 070111
OC 4 Bordó RAL 3009		9 122,00 070876
MH 5 Cserépszín RAL 8004	9 166,00 070326	
SB 6 Törtfehér RAL 9002	9 166,00 071286	9 166,00 071293
BH 7 Világos ezüst RAL 9006	9 166,00 069887	9 166,00 069894
PS 8 Galambszürke RAL 7037	9 166,00 071064	9 166,00 071071
MM 9 Réz barna RAL extra	9 653,00 070487	
BHT – P.20 10 Sötét ezüst RAL 9007	9 852,00 096166	
MZ 11 Mohazöld RAL 6005	9 653,00 070654	
MOT 12 Kék RAL 5010		9 653,00 070579
TZ 13 Zöld RAL 6011	9 653,00 071583 *	
Csomagolás m 	3	4
Csomagolás m 	84	112

* Gyártás rendelésre

LEFOLYÓCSŐ TOLDÓ

P-PSRU

Névleges méret	80	100	120
Ár HUF/db	Áfával	Áfával	Áfával
TM 1 Barna RAL 8028	1 882,00 017581	1 948,00 017598	2 170,00 017604
AN 2 Antracit RAL 7016	1 882,00 017284	1 948,00 017291	2 170,00 017307
IC 3 Fekete RAL 9005	1 882,00 017345	1 948,00 017352	2 170,00 017369
OC 4 Bordó RAL 3009	1 882,00 017499	1 948,00 017505	2 170,00 017512
MH 5 Cserépszín RAL 8004	1 882,00 017376	1 948,00 017383	2 170,00 017390
SB 6 Törtfehér RAL 9002	1 882,00 017550	1 948,00 017567	2 170,00 017574
BH 7 Világos ezüst RAL 9006	1 882,00 017314	1 948,00 017321	2 170,00 017338
PS 8 Galambszürke RAL 7037	1 882,00 017529	1 948,00 017536	2 170,00 017543
MM 9 Réz barna RAL extra	1 882,00 017406	1 948,00 017413	2 170,00 017420
BHT – P.20 10 Sötét ezüst RAL 9007	1 882,00 095657 *	1 948,00 095664	2 170,00 095671 *
MZ 11 Mohazöld RAL 6005	1 882,00 017468 *	1 948,00 017475	2 170,00 017482
MOT 12 Kék RAL 5010	1 882,00 017437 *	1 948,00 017444	2 170,00 017451
TZ 13 Zöld RAL 6011	1 882,00 017611 *	1 948,00 017628	2 170,00 017635 *
Csomagolás db	10	10	8
Csomagolás db	900	900	720

* Gyártás rendelésre



LÁBAZATI ELEM

P-PKO



Névleges méret	80	100	120
Ár HUF/db	Áfával	Áfával	Áfával
TM 1 Barna RAL 8028	4 162,00 034045	4 295,00 034052	6 177,00 034069
AN 2 Antracit RAL 7016	4 162,00 033741	4 295,00 033758	6 177,00 033765
IC 3 Fekete RAL 9005	4 162,00 033802	4 295,00 033819	6 177,00 033826
OC 4 Bordó RAL 3009	4 162,00 033956	4 295,00 033963	6 177,00 033970
MH 5 Cserépszín RAL 8004	4 162,00 033833	4 295,00 033840	6 177,00 033857
SB 6 Törtfehér RAL 9002	4 162,00 034014	4 295,00 034021	6 177,00 034038
BH 7 Világos ezüst RAL 9006	4 162,00 033772	4 295,00 033789	6 177,00 033796
PS 8 Galambszürke RAL 7037	4 162,00 033987	4 295,00 033994	6 177,00 034007
MM 9 Réz barna RAL extra	4 162,00 033864	4 295,00 033871	6 177,00 033888
BHT – P.20 10 Sötét ezüst RAL 9007	4 162,00 095688	4 295,00 095695	6 177,00 095701
MZ 11 Mohazöld RAL 6005	4 162,00 033925	4 295,00 033932	6 177,00 033949
MOT 12 Kék RAL 5010	4 162,00 033895	4 295,00 033901	6 177,00 033918
TZ 13 Zöld RAL 6011	4 162,00 034076	4 295,00 034083	6 177,00 034090
Csomagolás db 📦	20	20	15
Csomagolás db 🚚	320	240	180

Y-ELÁGAZÁS 72°

P-PZO

Névleges méret	80/80	100/60	100/80	100/100
Ár HUF/db	Áfával	Áfával	Áfával	Áfával
TM 1 Barna RAL 8028	6 930,00 016157	7 705,00 016164	7 705,00 016171	7 970,00 016188
AN 2 Antracit RAL 7016	6 930,00 015259	7 705,00 015266	7 705,00 015273	7 970,00 015280
IC 3 Fekete RAL 9005	6 930,00 015433	7 705,00 015440	7 705,00 015457	7 970,00 015464
OC 4 Bordó RAL 3009	6 930,00 015884	7 705,00 015891	7 705,00 015907	7 970,00 015914
MH 5 Cserépszín RAL 8004	6 930,00 015525	7 705,00 015532 *	7 705,00 015549	7 970,00 015556
SB 6 Törtfehér RAL 9002	6 930,00 016065	7 705,00 016072 *	7 705,00 016089	7 970,00 016096
BH 7 Világos ezüst RAL 9006	6 930,00 015341	7 705,00 015358 *	7 705,00 015365	7 970,00 015372
PS 8 Galambszürke RAL 7037	6 930,00 015976 *	7 705,00 015983 *	7 705,00 015990	7 970,00 016003
MM 9 Réz barna RAL extra	6 930,00 015617	7 705,00 015624 *	7 705,00 015631	7 970,00 015648
BHT – P.20 10 Sötét ezüst RAL 9007	6 930,00 096005 *		7 705,00 096012 *	7 970,00 096029 *
MZ 11 Mohazöld RAL 6005	6 930,00 015792	7 705,00 015808 *	7 705,00 015815	7 970,00 015822
MOT 12 Kék RAL 5010	6 930,00 015709 *	7 705,00 015716 *	7 705,00 015723 *	7 970,00 015730
TZ 13 Zöld RAL 6011	6 930,00 016249 *	7 705,00 016256 *	7 705,00 016263 *	7 970,00 016270 *
Csomagolás db	4	4	4	4
Csomagolás db	120	120	120	120

* Gyártás rendelésre



Y-ELÁGAZÁS 72°

P-PZO



Névleges méret	120/80	120/100	120/120	150/120	150/150
Ár HUF/db	Áfával	Áfával	Áfával	Áfával	Áfával
TM 1 Barna RAL 8028	8 767,00	8 767,00	8 767,00	12 753,00	12 753,00
	016195	016201	016218	016225 *	016232 *
AN 2 Antracit RAL 7016	8 767,00	8 767,00	8 767,00	12 753,00	12 753,00
	015297	015303	015310	015327 *	015334 *
IC 3 Fekete RAL 9005	8 767,00	8 767,00	8 767,00	12 753,00	12 753,00
	015471	015488	015495	015501 *	015518 *
OC 4 Bordó RAL 3009	8 767,00	8 767,00	8 767,00	12 753,00	12 753,00
	015921	015938	015945	015952 *	015969 *
MH 5 Cserépszín RAL 8004	8 767,00	8 767,00	8 767,00	12 753,00	12 753,00
	015563	015570	015587	015594 *	015600 *
SB 6 Törtfehér RAL 9002	8 767,00	8 767,00	8 767,00	12 753,00	12 753,00
	016102	016119	016126	016133 *	016140 *
BH 7 Világos ezüst RAL 9006	8 767,00	8 767,00	8 767,00	12 753,00	12 753,00
	015389	015396	015402	015419 *	015426 *
PS 8 Galambszürke RAL 7037	8 767,00	8 767,00	8 767,00	12 753,00	12 753,00
	016010 *	016027	016034	016041 *	016058 *
MM 9 Réz barna RAL extra	8 767,00	8 767,00	8 767,00	12 753,00	12 753,00
	015655 *	015662	015679	015686 *	015693 *
BHT – P.20 10 Sötét ezüst RAL 9007	8 767,00	8 767,00	8 767,00		
	096036 *	096043 *	096050 *		
MZ 11 Mohazöld RAL 6005	8 767,00	8 767,00	8 767,00	12 753,00	12 753,00
	015839 *	015846 *	015853 *	015860 *	015877 *
MOT 12 Kék RAL 5010	8 767,00	8 767,00	8 767,00	12 753,00	12 753,00
	015747 *	015754 *	015761 *	015778 *	015785 *
TZ 13 Zöld RAL 6011	8 767,00	8 767,00	8 767,00	12 753,00	12 753,00
	016287 *	016294 *	016300 *	016317 *	016324 *
Csomagolás db 	3	3	3	2	2
Csomagolás db 	90	90	90	36	36

* Gyártás rendelésre

LEFOLYÓ VÍZELOSZTÓ

P-PRV



ACÉL
POLYESTER





Névleges méret	80	100	120
Ár HUF/db	Áfával	Áfával	Áfával
TM 1 Barna RAL 8028	86 346,00 088413 *	88 516,00 088420	114 685,00 088437 *
AN 2 Antracit RAL 7016	86 346,00 088116 *	88 516,00 088123	114 685,00 088130 *
IC 3 Fekete RAL 9005	86 346,00 088178 *	88 516,00 088185 *	114 685,00 088192 *
OC 4 Bordó RAL 3009	86 346,00 088321 *	88 516,00 088338 *	114 685,00 088345 *
MH 5 Cserépszín RAL 8004	86 346,00 088208 *	88 516,00 088215 *	114 685,00 088222 *
SB 6 Törtfehér RAL 9002	86 346,00 088383 *	88 516,00 088390 *	114 685,00 088406 *
BH 7 Világos ezüst RAL 9006	86 346,00 088147 *	88 516,00 088154 *	114 685,00 088161 *
PS 8 Galambszürke RAL 7037	86 346,00 088352 *	88 516,00 088369 *	114 685,00 088376 *
MM 9 Réz barna RAL extra	86 346,00 088239 *	88 516,00 088246 *	114 685,00 088253 *
BHT – P.20 10 Sötét ezüst RAL 9007	86 346,00 095756 *	88 516,00 095763 *	114 685,00 095770 *
MZ 11 Mohazöld RAL 6005	86 346,00 088291 *	88 516,00 088307 *	114 685,00 088314 *
MOT 12 Kék RAL 5010	86 346,00 088260 *	88 516,00 088277 *	114 685,00 088284 *
TZ 13 Zöld RAL 6011	86 346,00 088444 *	88 516,00 088451 *	114 685,00 088468 *
Csomagolás db	1	1	1
Csomagolás db	–	–	–

* Gyártás rendelésre

BILINCS SZÁRRAL 150 mm

P-PO





Névleges méret	80	100	120
Ár HUF/db	Áfával	Áfával	Áfával
TM 1 Barna RAL 8028	1 461,00 002136	1 483,00 002143	1 771,00 002150
AN 2 Antracit RAL 7016	1 461,00 001986	1 483,00 001993	1 771,00 002006
Csomagolás db 	25	25	25
Csomagolás db 	1 000	1 000	1 000

BILINCS SZÁRRAL 200 mm

P-POD





Névleges méret	80	100	120
Ár HUF/db	Áfával	Áfával	Áfával
TM 1 Barna RAL 8028	1 550,00 001955	1 550,00 001962	1 793,00 001979
AN 2 Antracit RAL 7016	1 550,00 001801	1 550,00 001818	1 793,00 001825
Csomagolás db 	25	25	25
Csomagolás db 	1 000	1 000	1 000

BILINCS SZÁRRAL 300 mm

P-PODD



Névleges méret	100	120
Ár HUF/db	Áfával	Áfával
TM 1 Barna RAL 8028	2 015,00 002402	2 192,00 002419
AN 2 Antracit RAL 7016	2 015,00 002303	2 192,00 002310
Csomagolás db 	20	20
Csomagolás db 	800	800



BILINCSFEJ MENETES M10

P-POB

Névleges méret	60	80	100	120	150
Ár HUF/db	Áfával	Áfával	Áfával	Áfával	Áfával
TM 1 Barna RAL 8028	1 284,00 074119	1 173,00 074126	1 218,00 074133	1 461,00 074140	2 170,00 074157
AN 2 Antracit RAL 7016	1 284,00 073471	1 173,00 073488	1 218,00 073495	1 461,00 073501	2 170,00 073518
IC 3 Fekete RAL 9005	1 284,00 073679	1 173,00 073686	1 218,00 073693	1 461,00 073709	2 170,00 073716
OC 4 Bordó RAL 3009	1 284,00 073914	1 173,00 073921	1 218,00 073938	1 461,00 073945	2 170,00 073952
MH 5 Cserépszín RAL 8004	1 284,00 073723	1 173,00 073730	1 218,00 073747	1 461,00 073754	2 170,00 073761
SB 6 Törtfehér RAL 9002	1 284,00 074010	1 173,00 074027	1 218,00 074034	1 461,00 074041	2 170,00 074058
BH 7 Világos ezüst RAL 9006	1 284,00 073570	1 173,00 073587	1 218,00 073594	1 461,00 073600	2 170,00 073617
PS 8 Galambszürke RAL 7037	1 284,00 073969	1 173,00 073976	1 218,00 073983	1 461,00 073990	2 170,00 074003
MM 9 Réz barna RAL extra	1 284,00 073778	1 173,00 073785	1 218,00 073792	1 461,00 073808	2 170,00 077158
BHT – P.20 10 Sötét ezüst RAL 9007	1 284,00 119711	1 173,00 094537	1 218,00 094544	1 461,00 094551	2 170,00 094674
MZ 11 Mohazöld RAL 6005	1 284,00 073860	1 173,00 073877	1 218,00 073884	1 461,00 073891	2 170,00 073907
MOT 12 Kék RAL 5010	1 284,00 073815	1 173,00 073822	1 218,00 073839	1 461,00 073846	2 170,00 073853
TZ 13 Zöld RAL 6011	1 284,00 074164 *	1 173,00 074171	1 218,00 074188	1 461,00 074195	2 170,00 074201 *
Csomagolás db	25	25	25	25	20
Csomagolás db	3 000	3 000	3 000	3 000	2 400



* Gyártás rendelésre

BILINCSFEJ MENETES M8

P-POB





Névleges méret	60	80	100	120	150
Ár HUF/db	Áfával	Áfával	Áfával	Áfával	Áfával
TM 1 Barna RAL 8028	1 284,00	1 173,00	1 218,00	1 461,00	2 170,00
	074065	074072	074089	074096	074102
AN 2 Antracit RAL 7016	1 284,00	1 173,00	1 218,00	1 461,00	2 170,00
	073426	073433	073440	073457	073464
IC 3 Fekete RAL 9005	1 284,00	1 173,00	1 218,00	1 461,00	2 170,00
	073624	073631	073648	073655	073662
BH 7 Világos ezüst RAL 9006	1 284,00	1 173,00	1 218,00	1 461,00	2 170,00
	073532	073525	073549	073556	073563
Csomagolás db	25	25	25	25	20
Csomagolás db	3 000	3 000	3 000	3 000	2 400



ROZSDAMENTES ÁCEL CSAVAR BILINCSHEZ M6x20

P-POB-NSK



Névleges méret	EAN szám	Csomagolás db		Ár áfával [HUF/db]
				
M6 x 20 *	071675	1	–	70,00



* Gyártás rendelésre

CSAVAR BILINCSHEZ MENETES SZÁRRAL TORX M10

P-POB-HT





ACÉL
POLYESTER

Névleges méret	EAN szám	Csomagolás db		Ár áfával [HUF/db]
				
80	002464	100	40 000	440,00
140	002471	100	28 000	550,00
200	002488	100	20 000	690,00
250	002495	100	16 000	750,00
300	002501	100	11 200	750,00

TIPLI M10

P-POB-HN DB





Névleges méret	EAN szám	Csomagolás db		Ár áfával [HUF/db]
				
120	002426	100	25 000	180,00

TIPLI ZÁRO KUPAKALL M10

P-POB-HN DB





Névleges méret	EAN szám	Csomagolás db		Ár áfával [HUF/db]
				
180	002433	100	12 000	190,00
240	002440	100	12 000	220,00
280	002457	100	12 000	230,00

TŐCSAVAR TORX M10

P-POB-ZT/SZ



Névleges méret	EAN szám	Csomagolás db		Ár áfával [HUF/db]
				
140	002587	50	10 400	200,00
180	002594	50	10 400	240,00

TIPLI NÉGYSZÖGLETES MENETHEZ 7x7

P-POB-HN R1



Névleges méret	EAN szám	Csomagolás db		Ár áfával [HUF/db]
200/60	002600	250	15 000	80,00

HUNGAROCELL TIPLI M10

P-POB-HN IZOL



Névleges méret	EAN szám	Csomagolás db		Ár áfával [HUF/db]
M10 x 96	001207	25	2 625	1 200,00

SZIGETELŐ DÜBEL CSAVARHEGY TÉGLA SZIGETELÉS NÉLKÜL P-POB-HN WDVS140 M10



Névleges méret	EAN szám	Csomagolás db		Ár áfával [HUF/db]
140	144843	1/5	750	2 130,00

SZIGETELŐ DÜBEL CSAVARHEGY SZIGETELÉSSSEL ELLÁTOTT TÉGLA P-POB-HN WDVS300 M10



Névleges méret	EAN szám	Csomagolás db		Ár áfával [HUF/db]
300	144850	1/5	500	3 450,00

ROZSDAMENTES ACÉL UNI PLATFORM OB M10 MÉRETŰ BILINCS RÖGZÍTÉSÉHEZ P-POB-HN PLAT M10



Névleges méret	EAN szám	Csomagolás db		Ár áfával [HUF/db]
M10	144836	25/500	5 000	1 480,00

MENETES RÚD M10

P-POB-ZT



Névleges méret	EAN szám	Csomagolás db		Ár áfával [HUF/db]
60	002556	100	20 800	90,00
100	002563	100	15 600	130,00
150	002570	50	10 400	240,00



FALRA ROGZÍTHETŐ CSÖBILINCS TALP M10

P-POB-ZT MP

Névleges méret	EAN szám	Csomagolás db		Ár áfával [HUF/db]
80 x 30	002518	25	5 200	510,00

CSAVAR BILINCSHEZ MENETES SZÁRRAL M8

P-POB-HB

Névleges méret	EAN szám	Csomagolás db		Ár áfával [HUF/db]
150	071590	100	5 000	290,00
200	071606	100	5 000	410,00
250	071613	100	5 000	460,00
300	071620	100	5 000	490,00

TIPLI M8

P-POB-HBN-SS

Névleges méret	EAN szám	Csomagolás db		Ár áfával [HUF/db]
150	071637	100	5 000	90,00
200	071644	100	5 000	110,00
250	071651	100	5 000	110,00
300	071668	100	8 000	160,00

TAKARÓSAPKA MENETES SZÁRHOZ

P-POB-HT AKG

Névleges méret	EAN szám	Csomagolás db		Ár áfával [HUF/db]
29 x 13	002280	50	16 800	110,00
29 x 13	002211	50	16 800	110,00
29 x 13	002235	50	16 800	110,00
29 x 13	002266	50	16 800	110,00
29 x 13	002242	50	16 800	110,00
29 x 13	002228	50	16 800	110,00
29 x 13	002273	50	16 800	110,00
29 x 13	002259	50	16 800	110,00
29 x 13	002297	50	16 800	110,00



ESŐLOPÓ

P-PZV



Névleges méret	80	100	120
Ár HUF/db	Áfával	Áfával	Áfával
TM 1 Barna RAL 8028	5 557,00 034533	5 734,00 034540	8 413,00 034557
AN 2 Antracit RAL 7016	5 557,00 034410	5 734,00 034427	8 413,00 034434
IC 3 Fekete RAL 9005	5 557,00 034441	5 734,00 034458	8 413,00 034465
OC 4 Bordó RAL 3009	5 557,00 034502	5 734,00 034519	8 413,00 034526
MH 5 Cserépszín RAL 8004	5 557,00 034472	5 734,00 034489	8 413,00 034496
Csomagolás db	6	5	3
Csomagolás db	180	150	90

ESŐLOPÓ SZÜRÖVEL

P-PZVS

Névleges méret	80	100	120
Ár HUF/db	Áfával	Áfával	Áfával
TM 1 Barna RAL 8028	5 557,00 034861	5 734,00 034878	8 413,00 034885
AN 2 Antracit RAL 7016	5 557,00 034564	5 734,00 034571	8 413,00 034588
IC 3 Fekete RAL 9005	5 557,00 034625	5 734,00 034632	8 413,00 034649
OC 4 Bordó RAL 3009	5 557,00 034779	5 734,00 034786	8 413,00 034793
MH 5 Cserépszín RAL 8004	5 557,00 034656	5 734,00 034663	8 413,00 034670
SB 6 Törtfehér RAL 9002	5 557,00 034830	5 734,00 034847	8 413,00 034854
BH 7 Világos ezüst RAL 9006	5 557,00 034595	5 734,00 034601	8 413,00 034618
PS 8 Galambszürke RAL 7037	5 557,00 034809	5 734,00 034816	8 413,00 034823
MM 9 Réz barna RAL extra	5 557,00 034687	5 734,00 034694	8 413,00 034700
BHT – P.20 10 Sötét ezüst RAL 9007	5 557,00 095718	5 734,00 095725	8 413,00 095732
MZ 11 Mohazöld RAL 6005	5 557,00 034748	5 734,00 034755	8 413,00 034762
MOT 12 Kék RAL 5010	5 557,00 034717	5 734,00 034724	8 413,00 034731
TZ 13 Zöld RAL 6011	5 557,00 034892 *	5 734,00 034908	8 413,00 034915
Csomagolás db	6	5	3
Csomagolás db	180	150	90

* Gyártás rendelésre



ACÉL
POLYESTER

ESŐLOPÓ TÖMLÖVEL

P-PZVHA



Névleges méret	80	120
Ár HUF/db	Áfával	Áfával
TM 1 Barna RAL 8028	28 782,00 018793	55 350,00 018816
AN 2 Antracit RAL 7016	28 782,00 018496	55 350,00 018519
IC 3 Fekete RAL 9005		
OC 4 Bordó RAL 3009	28 782,00 018700	55 350,00 018724 *
MH 5 Cserépszín RAL 8004	28 782,00 018588 *	55 350,00 018601 *
SB 6 Törtfehér RAL 9002	28 782,00 018762 *	55 350,00 018786
BH 7 Világos ezüst RAL 9006		
PS 8 Galambszürke RAL 7037	28 782,00 018731 *	55 350,00 018755 *
MM 9 Réz barna RAL extra	28 782,00 018618 *	55 350,00 018632 *
BHT – P.20 10 Sötét ezüst RAL 9007	28 782,00 095527 *	55 350,00 095541 *
MZ 11 Mohazöld RAL 6005		
MOT 12 Kék RAL 5010	28 782,00 018649 *	55 350,00 018663 *
TZ 13 Zöld RAL 6011	28 782,00 018823 *	55 350,00 018847 *
Csomagolás db	1	1
Csomagolás db	60	60

* Gyártás rendelésre

VÍZLOPÓ TÖMLŐVEL ÉS GOMBBAL

P-PZVHAG

Névleges méret	100
Ár HUF/db	Áfával
TM 1 Barna RAL 8028	26 568,00 018809
AN 2 Antracit RAL 7016	26 568,00 018502
IC 3 Fekete RAL 9005	
OC 4 Bordó RAL 3009	26 568,00 018717
MH 5 Cserépszín RAL 8004	26 568,00 018595
SB 6 Törtfehér RAL 9002	26 568,00 018779
BH 7 Világos ezüst RAL 9006	
PS 8 Galambszürke RAL 7037	26 568,00 018748
MM 9 Réz barna RAL extra	26 568,00 018625 *
BHT – P.20 10 Sötét ezüst RAL 9007	26 568,00 095534 *
MZ 11 Mohazöld RAL 6005	
MOT 12 Kék RAL 5010	26 568,00 018656 *
TZ 13 Zöld RAL 6011	26 568,00 018830 *
Csomagolás db	1
Csomagolás db	60

* Gyártás rendelésre

ACÉL
POLYESTER



REVISO ÁLLVÁNYCSŐ SZÍN

P-POZR





Névleges méret	80	100	100
Hossz m	1,0	1,0	1,5
Ár HUF/m	Áfával	Áfával	Áfával
TM Barna RAL 8028	28 339,00 010254 *	21 697,00 010261	42 952,00 010278
AN Antracit RAL 7016	28 339,00 009760 *	21 697,00 009777	42 952,00 009784 *
IC Fekete RAL 9005	28 339,00 009869 *	21 697,00 009876	42 952,00 009883 *
OC Bordó RAL 3009	28 339,00 010117 *	21 697,00 010124 *	42 952,00 010131 *
MH Cserépszín RAL 8004	28 339,00 009913 *	21 697,00 009920 *	42 952,00 009937 *
SB Törtfehér RAL 9002	28 339,00 010209 *	21 697,00 010247 *	42 952,00 010216 *
BH Világos ezüst RAL 9006	28 339,00 009814 *	21 697,00 009821 *	42 952,00 009838 *
PS Galambszürke RAL 7037	28 339,00 010162 *	21 697,00 010179 *	42 952,00 010186 *
MM Réz barna RAL extra	28 339,00 009968 *	21 697,00 009975 *	42 952,00 009982 *
BHT – P.20 Sötét ezüst RAL 9007	28 339,00 096494 *	21 697,00 096500 *	
MZ Mohazöld RAL 6005	28 339,00 010063 *	21 697,00 010070 *	42 952,00 010087 *
MOT Kék RAL 5010	28 339,00 010018 *	21 697,00 010025 *	42 952,00 010032 *
TZ Zöld RAL 6011	28 339,00 010308 *	21 697,00 010315 *	42 952,00 010322 *
Csomagolás db	1	1	1
Csomagolás db	70	60	60

* Gyártás rendelésre

ACÉL POLYESTER

REVISO ÁLLVÁNYCSŐ SZÍN



P-POZR

Névleges méret	120	120
Hossz m	1,0	1,5
Ár HUF/m	Áfával	Áfával
TM 1 Barna RAL 8028	50 922,00	73 062,00
	010285	010292 *
AN 2 Antracit RAL 7016	50 922,00	73 062,00
	009791 *	009807 *
IC 3 Fekete RAL 9005	50 922,00	73 062,00
	009890 *	009906 *
OC 4 Bordó RAL 3009	50 922,00	73 062,00
	010148 *	010155 *
MH 5 Cserépszín RAL 8004	50 922,00	73 062,00
	009944 *	009951 *
SB 6 Törtfehér RAL 9002	50 922,00	73 062,00
	010223 *	010230 *
BH 7 Világos ezüst RAL 9006	50 922,00	73 062,00
	009845 *	009852 *
PS 8 Galambszürke RAL 7037	50 922,00	73 062,00
	010193 *	009753 *
MM 9 Réz barna RAL extra	50 922,00	73 062,00
	009999 *	010001 *
BHT – P.20 10 Sötét ezüst RAL 9007	50 922,00	73 062,00
	096517 *	
MZ 11 Mohazöld RAL 6005	50 922,00	73 062,00
	010094 *	010100 *
MOT 12 Kék RAL 5010	50 922,00	73 062,00
	010049 *	010056 *
TZ 13 Zöld RAL 6011	50 922,00	73 062,00
	010339 *	010346 *
Csomagolás db 	1	1
Csomagolás db 	40	40

* Gyártás rendelésre

GUMIS BILINCS CSAVAROS M10

P-POB-OZR

Névleges méret	EAN szám	Csomagolás db		Ár áfával [HUF/db]
				
80	002525	25	1 250	690,00
100	002532	25	1 250	890,00
120	002549	20	1 000	1 000,00



ACÉL
POLYESTER



