



# SYSTEM RYNNOWY PÓŁOKRĄGLY



**CENNIK**  
**2024**

ZAŁECANE CENY DETALICZNE



POWERFUL PARTNER FOR YOUR ROOF

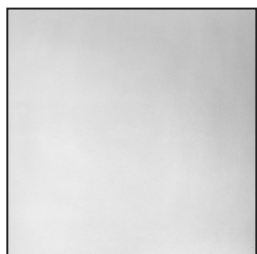

Material tytan-cynkowy | 3



Rynna | 6



Rynna dylatacyjna | 7



Rynna wyposażenie | 9



Hak połączeniowy | 10



Narożnik | 11



Denko rynny | 11



Wylot | 12



Kolano | 16



Rura spustowa | 17

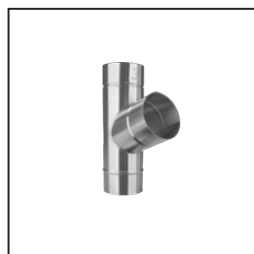

Rura spustowa wyposażenie | 18



Obejma rury | 19

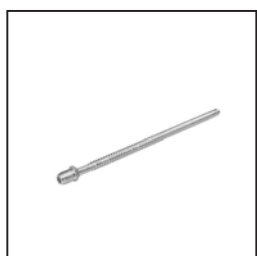

Obejma rury wyposażenie | 20



Rewizja rury spustowej | 23



Rura ochronna | 24

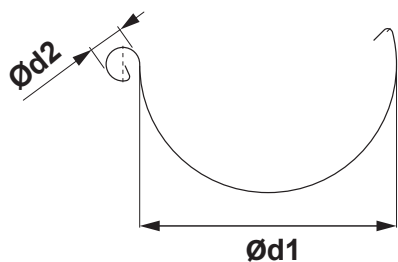

### WYMIARY RYNIEN DACHOWYCH

(wymiary i tolerancje wymiarów według normy EN 612)

Szerokość w rozwinięciu (mm)	200	250	280	333	400	500
Ød1	80	105	127	153	192	250
Ød2	16	18	18	20	22	22

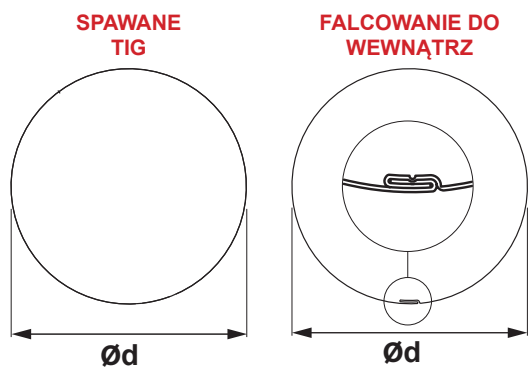

### WYMIARY RYNIEN DACHOWYCH

(wymiary i tolerancje wymiarów według normy EN 612)

Wymiary	60	80	100	120	FALCOWANIE 150
Wielkość nominalna Ød (mm)	60	80	100	120	150

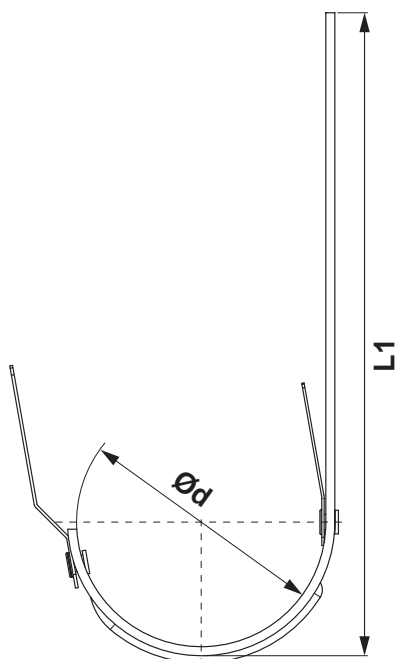

### WYMIARY HAKÓW DACHOWYCH

(wymiary i tolerancje wymiarów według normy EN 612)

Wymiary (mm)	L1	Ød
200	290	80
250	310	105
280	345	127
333 – 550	385	153
333 – 610	445	153
400	400	192

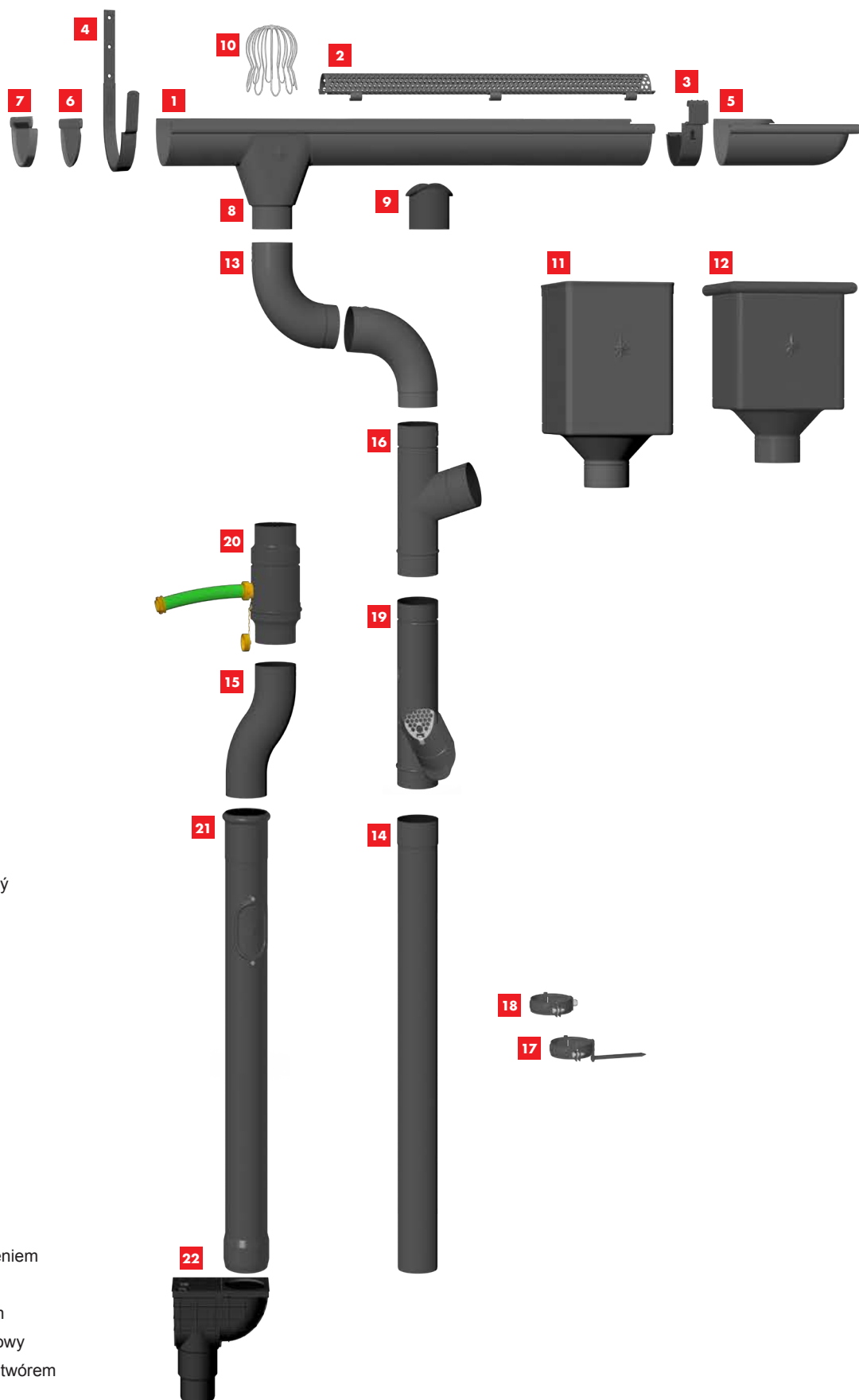

- 1** Rynna półokrągła
- 2** Kratka ochronna przed liśćmi
- 3** Łącznik rynny
- 4** Strešný žľabový hák obaľovaný
- 5** Narožník zewnętrzny
- 6** Denko rynny
- 7** Denko rynny z gumą
- 8** Wylot
- 9** Sztucer
- 10** Sito-łapacz liści
- 11** Kosz zlewowy DESIGN
- 12** Kosz zlewowy KUBICZNY
- 13** Kolano
- 14** Rura spustowa
- 15** Odsadzka
- 16** Trójnik
- 17** Obejma rury spustowej z trzpieniem
- 18** Obejma rury z gwintem M10
- 19** Rewizja rury spustowej z sitem
- 20** Zbiornik na wodę+wąż plastikowy
- 21** Rura ochronna z rewizyjnym otworem
- 22** Wyjście kanalizacyjne





# TYTAN-CYNK



## RYNNA PÓŁOKRĄGŁA [s=0,65 mm]

TZ-TZZ



Rozmiar nominalny	Długość w m	EAN numer produktu	Pakowanie w m		Cena z VAT [ZŁ/m]
					
200	3,0	047939	15	1 200	52,90
250	2,0	047946	10	480	50,40
250	3,0	047960	15	720	47,40
250	4,0	047984	20	960	47,40
250	5,0	047991	25	1 200	47,40
250	6,0	048004	30	1 440	47,40
280	2,0	048028	10	420	56,00
280	3,0	048042	15	630	52,90
280	4,0	048066	20	840	52,90
280	5,0	048080	25	1 050	52,90
280	6,0	048097	30	1 260	52,90
333	2,0	048103	10	330	62,10
333	3,0	048127	15	495	59,70
333	4,0	048141	20	660	59,70
333	5,0	048165	25	825	59,70
333	6,0	048196	30	990	59,70
400	4,0	048219	20	540	81,80
400	6,0	048233	30	810	81,80



TYTAN-CYNK

## RYNNA PÓŁOKRĄGŁA [s=0,70 mm]

TZ-TZZ



Rozmiar nominalny	Długość w m	EAN numer produktu	Pakowanie w m		Cena z VAT [ZŁ/m]
					
500 *	4,0	048257	20	–	156,50

\* Produkcja na zamówienie



## RYNNA LEŻĄCA

TZ-TZZS

Rozmiar nominalny	Długość w m	EAN numer produktu	Pakowanie w m		Cena z VAT [ZŁ/m]
					
650 *	4,0	000439	4	200	212,20

\* Produkcja na zamówienie



## RYNNA DYLATACYJNA

TZ-TZZDI

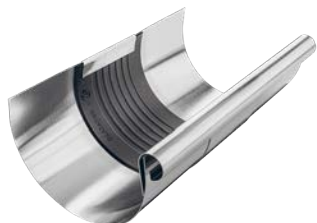

Rozmiar nominalny	EAN numer produktu	Pakowanie w szt.		Cena z VAT [ZŁ/szt.]
<b>250/260</b>	082688	3	360	<b>83,00</b>
<b>280/260</b>	082695	3	360	<b>84,30</b>
<b>333/260</b>	082701	5	200	<b>84,30</b>
<b>400/260</b>	082718	5	200	<b>108,20</b>



## DYLATACJA RYNNY LEŻĄCEJ

TZ-TZZSDI

Rozmiar nominalny	EAN numer produktu	Pakowanie w szt.		Cena z VAT [ZŁ/szt.]
<b>670/260</b>	082725	1	40	<b>224,50</b>

TYTAN-CYNK



## PAS DYLATACYJNY

TZ-TZZDIP

Rozmiar nominalny	Długość w m	EAN numer produktu	Pakowanie w m		Cena z VAT [ZŁ/m]
<b>260</b>	3,0	028020	3	120	<b>276,80</b>
<b>260</b>	6,0	028037	6	240	<b>276,80</b>

## ZASTOSOWANIE RYNNY DYLATACYJNEJ I DYLATACJI TAŚMOWEJ

### RYNNA DYLATACYJNA

**Przykładowy montaż: Rynna podokapowa o szerokości w rozwinięciu do 500 mm.** Rynnę dylatacyjną należy montować w odstępach co 15 m. Dla naroża zewnętrznego i początku rynny obowiązuje połowiczna wartość wartości standardowej: maksymalnie 7,5 m. Dla naroża zewnętrznego obowiązuje jedna czwarta wartości standardowej: maksymalnie 3,75 m. Dla pozostałych materiałów i wymiarów: patrz tabela poniżej. Naroża uwzględnianie są zawsze jako stałe punkty odniesienia.

### DACHOWE: RYNNY DYLATACYJNE PÓŁOKRĄGŁE

Szerokość w rozwinięciu rynny	Aluminium	Ocynkowane, Tytan-cynk, Miedź, Stal nierdzewna
< 500	12	15
> 500	8	10

### DYLATACJA TAŚMOWA

**Instalacja wewnętrzna:** dla rynien przymocowanych bez klejenia do podkładu, dachy o profilu niestandardowym i obudową muru blachami metalowymi.

### DACHOWA: DYLATACJA TAŚMOWA

Szerokość w rozwinięciu rynny	Aluminium	Ocynkowane, Tytan-cynk, Miedź, Stal nierdzewna
< 500	8	10
> 500	6	8

Dla naroża zewnętrznego obowiązuje połowa wartości standardowej. Dla naroża wewnętrznego obowiązuje jedna czwarta wartości standardowej.

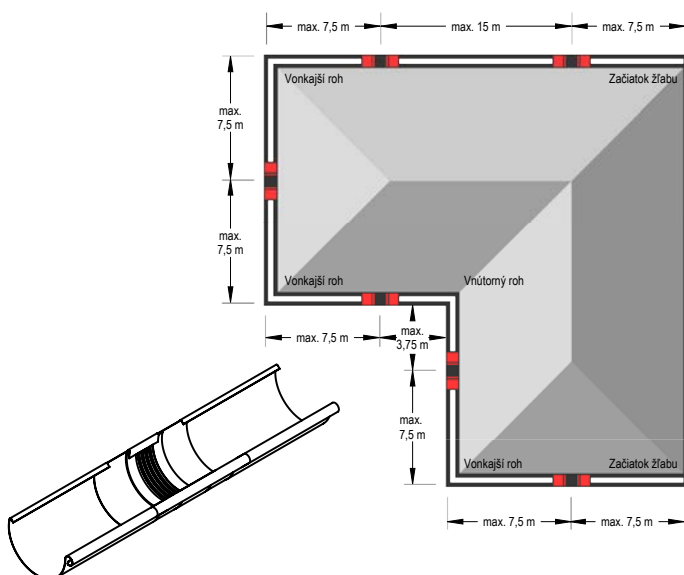

#### Uwaga dotycząca montażu rynny dylatacyjnej.

W trakcie montażu za pomocą lutowania środkowy element gumowy najpierw należy przykryć mokrą szmatką (aby nie doszło do przeniesienia energii cieplnej do środkowego elementu gumowego). Wymagane jest dotrzymanie minimalnej odległości 6 cm od środkowego elementu gumowego. W każdym przypadku trzeba uniknąć kontaktu gumy z otwartym ogniem (płomieniem).

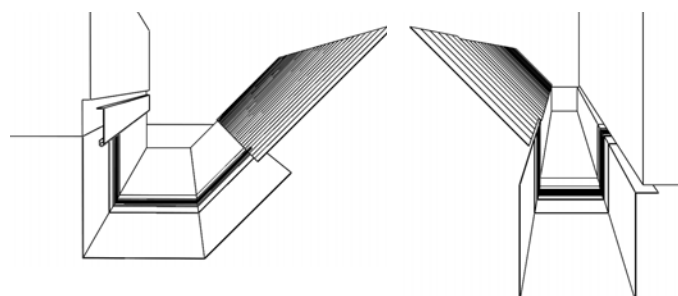

#### Uwaga dotycząca montażu taśmy dylatacyjnej Przed wykonaniem procesu gięcia i montażu elementów dylatacyjnych należy upewnić się, czy:

- Szczęki gięcia mają minimalny promień wartości 2 mm.
- Dla blach grubości powyżej 1 mm należy dotrzymywać minimalny promień gięcia wartości 5 mm.
- Szczęki gięcia należy ustawić na grubość środkowej części gumowej o wartości od 3 do 4 mm, aby zapobiec efektowi strzyżenia – uszkodzeniu gumy.
- Środkowa część gumowa przeznaczona do gięcia nie może być pofalowana lub uszkodzona. Z tego względu powinno się stosować taśmę aluminiową grubości od 2 mm do 5 mm wygiętą tak, aby można ją przymocować jako ochronę szczęk służących do gięcia. W ten sposób można zwiększyć promień gięcia i zapobiec przesunięciu się środkowej części gumowej.





## ALUMINIUM KRATKA OCHRONNA PRZED LIŚĆMI

W-WZNLM

Rozmiar nominalny	Dłżka v m	EAN numer produktu	Pakowanie w szt.		Cena z VAT [ZŁ/szt.]
333	2,0	064905	25	300	156,80

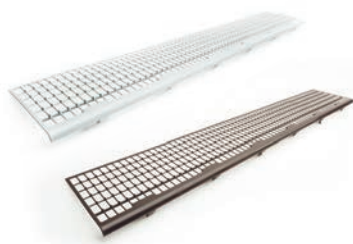

## PVC LAPAĆ LIŚĆIA

SD-ZNL MRIEZKA

Rozmiar nominalny	Dłżugość w m	EAN numer produktu	Pakowanie w szt.		Cena z VAT [ZŁ/szt.]
171	1,0	008473	30	450	27,70
171	1,0	008466	30	450	27,70

TYTAN-CYNK

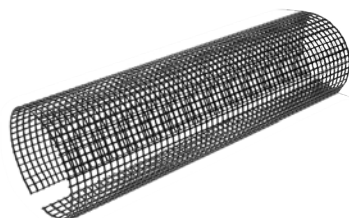

## PVC LAPAĆ LIŚĆIA

SD-ZNL N



Rozmiar nominalny	Dłżugość w m	EAN numer produktu	Pakowanie w szt.		Cena z VAT [ZŁ/szt.]
250	3,0	008480	10	400	147,00
280-333	3,0	008497	10	400	147,60





## ŁĄCZNIK RYNNY



## TZ-TZSPZ

Rozmiar nominalny	EAN numer produktu	Pakowanie w szt.		Cena z VAT [ZŁ/szt.]
				
<b>250 *</b>	102454	5	600	<b>W PROCESIE TESTÓW</b>
<b>280 *</b>	102461	5	600	<b>W PROCESIE TESTÓW</b>
<b>333 *</b>	102478	5	600	<b>W PROCESIE TESTÓW</b>

\* Produkcja na zamówienie

## ŽŁABOVÝ HÁK OBALOVANÝ



## TZ-TZHOB

Rozmiar nominalny	Materiál	EAN numer produktu	Pakowanie w szt.		Cena z VAT [ZŁ/szt.]
					
<b>200/380</b>	25/6	032805	10	1 000	<b>27,10</b>
<b>250/430</b>	25/6	032812	10	1 000	<b>21,50</b>
<b>280/480</b>	25/6	032829	10	1 000	<b>23,40</b>
<b>333/550</b>	25/6	032836	10	1 000	<b>24,60</b>
<b>333/610</b>	25/6	032843	10	1 000	<b>29,20</b>
<b>400/650</b>	25/6	032850	10	500	<b>39,10</b>



## HÁK DO RYNNY LEŽÁCEJ Z PODPACIEM

## TZ-TZHOBSSN



Rozmiar nominalny	Materiál	EAN numer produktu	Pakowanie w szt.		Cena z VAT [ZŁ/szt.]
					
<b>4</b>	25/6	000910	15	300	<b>106,40</b>



## NAROŻNIK ZEWNĘTRZNY

## TZ-TZRA





Rozmiar nominalny	EAN numer produktu	Pakowanie w szt.		Cena z VAT [ZŁ/szt.]
				
200	000811	5	150	92,30
250	000828	5	150	92,30
280	000835	5	150	102,10
333	000842	5	150	102,10
400	000859	5	150	202,30

## NAROŻNIK WEWNĘTRZNY

## TZ-TZRI





Rozmiar nominalny	EAN numer produktu	Pakowanie w szt.		Cena z VAT [ZŁ/szt.]
				
200	000866	5	150	92,30
250	000873	5	150	92,30
280	000880	5	150	102,10
333	000897	5	150	102,10
400	000903	5	150	202,30

## DENKO RYNNY

## TZ-TZCL





Rozmiar nominalny	EAN numer produktu	Pakowanie w szt.		Cena z VAT [ZŁ/szt.]
				
200	001665	6/60	1 440	4,90
250	001672	50	4 500	4,30
280	001689	50	4 500	4,90
333	001696	50	4 500	5,80
400	001702	4/40	960	9,50

## DENKO RYNNY Z GUMĄ

## TZ-TZCLG





Rozmiar nominalny	EAN numer produktu	Pakowanie w szt.		Cena z VAT [ZŁ/szt.]
				
250 *	004390	25	2 250	W PROCESIE TESTÓW
280 *	004406	25	2 250	W PROCESIE TESTÓW
333 *	004413	25	2 250	W PROCESIE TESTÓW

\* Produkcja na zamówienie

## WYLOT

## TZ-TZKL



Rozmiar nominalny	EAN numer produktu	Pakowanie w szt.		Cena z VAT [ZŁ/szt.]
				
<b>200/60</b>	003775	20	600	<b>53,50</b>
<b>250/60</b>	003782	20	600	<b>49,80</b>
<b>250/80</b>	003799	20	600	<b>40,00</b>
<b>280/80</b>	003805	20	600	<b>50,10</b>
<b>280/100</b>	003812	20	600	<b>46,10</b>
<b>333/80</b>	003829	20	600	<b>61,50</b>
<b>333/100</b>	003836	20	600	<b>50,40</b>
<b>333/120</b>	003843	15	300	<b>70,70</b>
<b>400/100</b>	003850	15	300	<b>98,40</b>
<b>400/120</b>	003867	15	300	<b>108,90</b>
<b>400/150</b>	003874	15	300	<b>129,20</b>

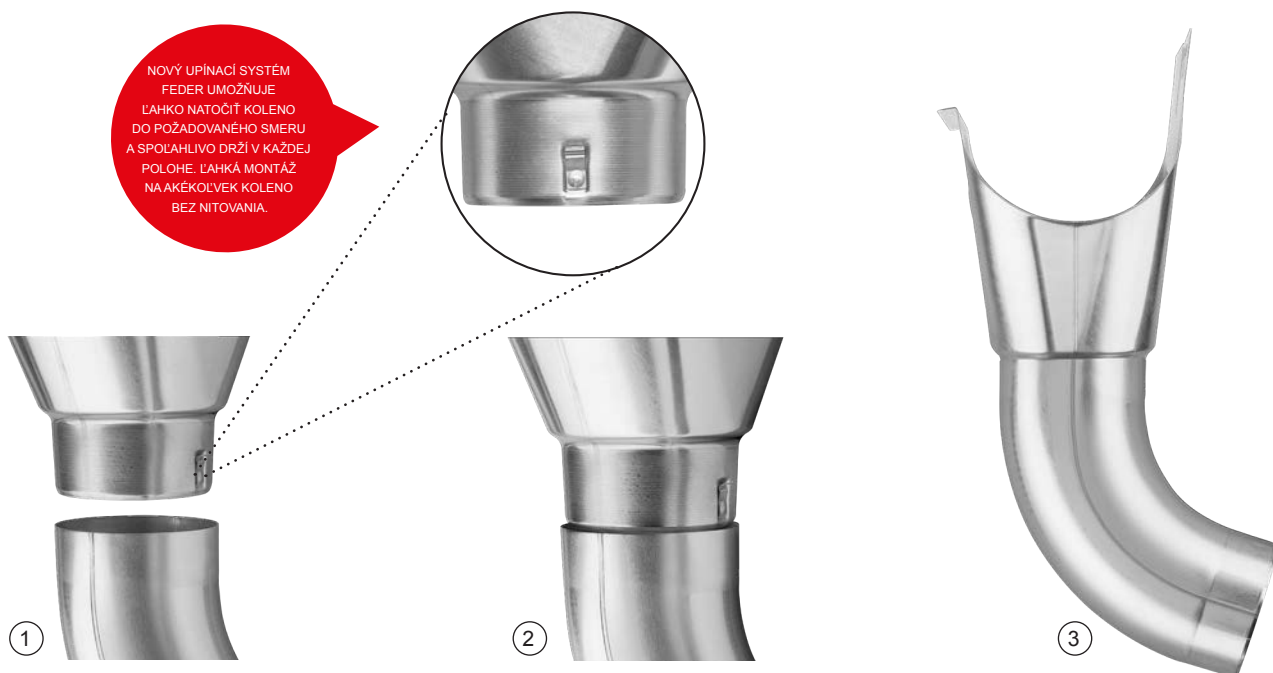

## SZTUCER

## TZ-TZHRD



Rozmiar nominalny	EAN numer produktu	Pakowanie w szt.		Cena z VAT [ZŁ/szt.]
80	102539	40	1 000	14,10
100	102546	25	1 000	16,00
120	102553	15	750	21,50

## SITO-ŁAPACZ LIŚCI STAL NIERDZEWNA

## N-NZN





Rozmiar nominalny	EAN numer produktu	Pakowanie w szt.		Cena z VAT [ZŁ/szt.]
60	001153	30	2 160	34,10
80	001160	20	1 440	34,40
100	001177	15	1 080	35,10
120	001184	10	720	38,10
150	001191	5	360	60,30



## KOSZ ZLEWOWY DESIGN

TZ-TZKLZ DE





Rozmiar nominalny	EAN numer produktu	Pakowanie w szt.		Cena z VAT [ZŁ/szt.]
				
80	007834	2	36	399,80
100	007858	2	36	399,80
120	007872	2	36	405,90

## KOSZ ZLEWOWY DESIGN EKSCENTRYCZNY

TZ-TZKLZ DX





Rozmiar nominalny	EAN numer produktu	Pakowanie w szt.		Cena z VAT [ZŁ/szt.]
				
80 *	007896	2	36	461,30
100	007926	2	36	461,30
120	007957	2	36	470,50

\* Produkcja na zamówienie

## KOSZ ZLEWOWY KUBICZNY

TZ-TZKLZ KU





Rozmiar nominalny	EAN numer produktu	Pakowanie w szt.		Cena z VAT [ZŁ/szt.]
				
80 *	007841	2	36	597,80
100	007865	2	36	597,80
120	007889	2	36	597,80

\* Produkcja na zamówienie

## KOSZ ZLEWOWY KUBICZNY EXZENTRYCKÝ

TZ-TZKLZ KX





Rozmiar nominalny	EAN numer produktu	Pakowanie w szt.		Cena z VAT [ZŁ/szt.]
				
80	007902	2	36	602,70
100	007933	2	36	602,70
120	007964	2	36	615,00

## KOSZ ZLEWOWY KUBICZNY EKSCENTRYCZNY Z RURĄ

TZ-TZKLZ KXV





Rozmiar nominalny	EAN numer produktu	Pakowanie w szt.		Cena z VAT [ZŁ/szt.]
				
80	007919	2	36	842,60
100	007940	2	36	842,60
120	007971	2	36	848,70

## USZCZELKA GUMOWA DO KOSZA ZLEWOWEGO

P-PKLZ T



Rozmiar nominalny	EAN numer produktu	Pakowanie w szt.		Cena z VAT [ZŁ/szt.]
				
<b>IC 70-85</b>	077103	5	600	<b>24,60</b>
<b>IC 100-110</b>	077110	5	600	<b>25,20</b>
<b>IC 110-125</b>	077097	5	600	<b>25,80</b>
<b>PS 70-85</b>	077134	5	600	<b>27,70</b>
<b>PS 100-110</b>	077141	5	600	<b>30,10</b>
<b>PS 110-125</b>	077127	5	600	<b>30,80</b>

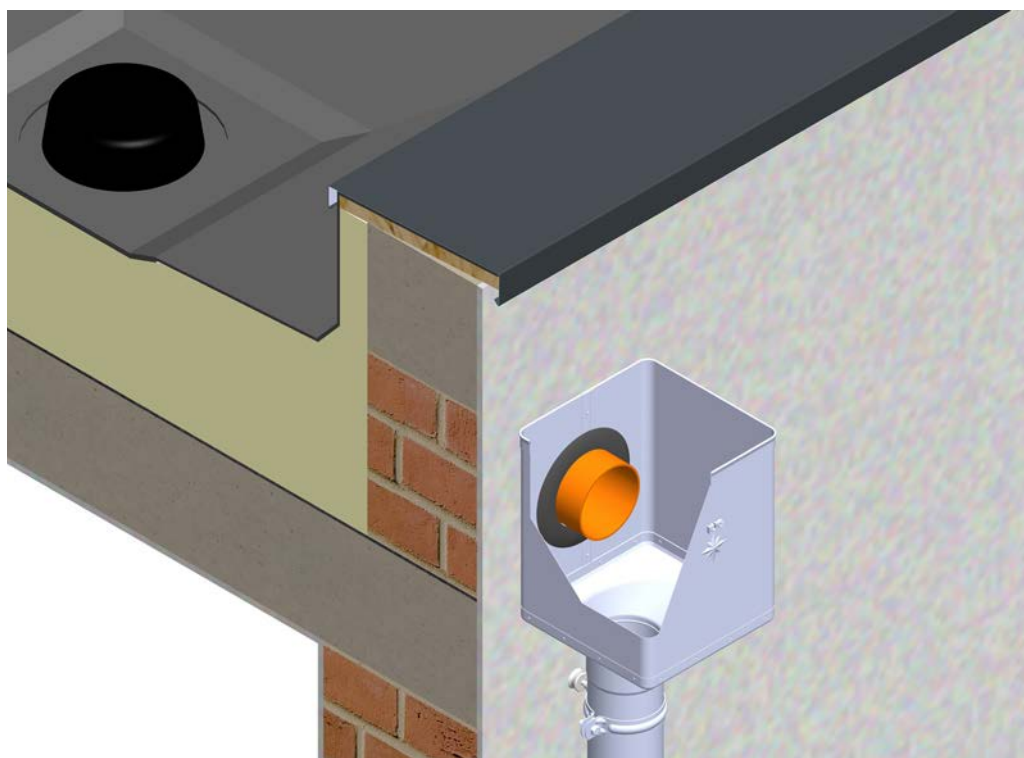

## KOLANO 72°

TZ-TZK



Rozmiar nominalny	EAN numer produktu	Pakowanie w szt.		Cena z VAT [ZŁ/szt.]
60	083081	25	600	37,50
80	083098	25	400	27,40
100	083111	25	300	32,00
120	083135	15	180	68,90
150	083159	5	90	239,90

## KOLANO PROMIEN 85°

TZ-TZKR



Rozmiar nominalny	EAN numer produktu	Pakowanie w szt.		Cena z VAT [ZŁ/szt.]
80	083104	25	400	48,00
100	083128	25	300	51,00
120	083142	15	180	112,50

## KOLANO TĘPE 40°

TZ-TZKT





Rozmiar nominalny	EAN numer produktu	Pakowanie w szt.		Cena z VAT [ZŁ/szt.]
80	083166	25	400	33,20
100	083173	25	300	42,40
120	083180	15	240	83,00



## RURA SPUSTOWA [s=0,65 mm]

TZ-TZZR



Rozmiar nominalny	Długość w m	EAN numer produktu	Pakowanie w m		Cena z VAT [ZŁ/m]
					
60	2,0	047618	2	490	47,00
60	3,0	047625	3	735	47,00
80	1,0	047649	10	100	52,00
80	2,0	047663	2	250	49,80
80	3,0	047687	3	375	49,80
80	4,0	047694	4	500	49,80
80 *	5,0	047700	5	625	49,80
80 *	6,0	047717	6	750	49,80
100	1,0	047731	10	70	62,70
100	2,0	047755	2	160	60,90
100	3,0	047779	3	240	60,90
100	4,0	047793	4	320	60,90
100 *	5,0	047816	5	400	60,90
100 *	6,0	047823	6	480	60,90
120	1,0	047830	8	48	80,30
120	2,0	047847	2	120	77,20
120	3,0	047854	3	180	77,20
120	4,0	047878	4	240	77,20
120 *	5,0	047892	5	300	77,20
120 *	6,0	047908	6	360	77,20



\* Produkcja na zamówienie

## RURA SPUSTOWA [s=0,70 mm]

TZ-TZZR



Rozmiar nominalny	Długość w m	EAN numer produktu	Pakowanie w m		Cena z VAT [ZŁ/m]
					
150 <sup>1</sup>	4,0	047922	4	112	169,40



<sup>1</sup> Falcowanie do wewnątrz

## PLASTIKOWY RĘKAW RURY SPUSTOWEJ

SD-ZR FOLIA KJG



Rozmiar nominalny	Długość w m	EAN numer produktu	Pakowanie w m		Cena z VAT [ZŁ/m]
					
60-150	100,0	139726	100	6 000	2,30







## ODSADZKA

## TZ-TZKO

Rozmiar nominalny	EAN numer produktu	Pakowanie w szt.		Cena z VAT [Zł/szt.]
				
<b>80</b>	047380	20	320	<b>56,60</b>
<b>100</b>	047397	20	240	<b>68,90</b>
<b>120</b>	047403	15	180	<b>129,20</b>

## TRÓJNIK 72°

## TZ-TZZO

Rozmiar nominalny	EAN numer produktu	Pakowanie w szt.		Cena z VAT [Zł/szt.]
				
<b>80/80</b>	102560	4	90	<b>103,30</b>
<b>100/60</b>	102577	4	120	<b>110,70</b>
<b>100/80</b>	102584	4	120	<b>110,70</b>
<b>100/100</b>	102591	4	120	<b>110,70</b>
<b>120/80</b>	102607	3	90	<b>137,80</b>
<b>120/100</b>	102614	3	90	<b>137,80</b>
<b>120/120</b>	102621	3	90	<b>137,80</b>
<b>150/120 *</b>	102638	2	36	<b>223,90</b>
<b>150/150 *</b>	102645	2	36	<b>242,90</b>

\* Produkcja na zamówienie

## OBEJMA RURY SPUSTOVEJ Z TRZPIENIEM 150 mm

TZ-TZO



Rozmiar nominalny	EAN numer produktu	Pakowanie w szt.		Cena z VAT [ZŁ/szt.]
80	008503	25	1 000	18,50
100	008510	25	1 000	20,30
120	008527	25	1 000	21,50

## OBEJMA RURY SPUSTOVEJ Z TRZPIENIEM 200 mm

TZ-TZOD



Rozmiar nominalny	EAN numer produktu	Pakowanie w szt.		Cena z VAT [ZŁ/szt.]
80	008534	25	1 000	19,70
100	008541	25	1 000	21,20
120	008558	25	1 000	22,40

## OBEJMA RURY SPUSTOVEJ Z TRZPIENIEM 300 mm

TZ-TZODD



Rozmiar nominalny	EAN numer produktu	Pakowanie w szt.		Cena z VAT [ZŁ/szt.]
100	008572	20	800	22,80
120	008589	20	800	25,20

## OBEJMA RURY SPUSTOVEJ Z GWINETEM M10



TZ-TZOB



Rozmiar nominalny	EAN numer produktu	Pakowanie w szt.		Cena z VAT [ZŁ/szt.]
60	000132	25	3 000	24,30
80	000149	25	3 000	18,50
100	000156	25	3 000	19,70
120	000163	25	3 000	22,80
150	000170	20	2 400	30,80





## STAL NIEREDZAWNA ŚRUBA DO OBEJMY RURY M6x20 P-POB-NSK

Rozmiar nominalny	EAN numer produktu	Pakowanie w szt.		Cena z VAT [ZŁ/szt.]
				
<b>M6 x 20 *</b>	071675	1	–	<b>0,90</b>

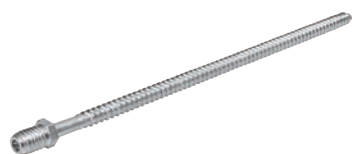
\* Produkcja na zamówienie





## SZTYFT DO OBEJMY Z NAKRĘTKĄ GWINTOWANĄ TORX M10 P-POB-HT

Rozmiar nominalny	EAN numer produktu	Pakowanie w szt.		Cena z VAT [ZŁ/szt.]
				
<b>80</b>	002464	100	40 000	<b>6,20</b>
<b>140</b>	002471	100	28 000	<b>7,70</b>
<b>200</b>	002488	100	20 000	<b>9,50</b>
<b>250</b>	002495	100	16 000	<b>10,50</b>
<b>300</b>	002501	100	11 200	<b>10,50</b>

TYTAN-CYNK





## KOŁEK M10 P-POB-HN DB

Rozmiar nominalny	EAN numer produktu	Pakowanie w szt.		Cena z VAT [ZŁ/szt.]
				
<b>120</b>	002426	100	25 000	<b>2,50</b>





## KOŁEK Z LAMELĄ M10 P-POB-HN DB

Rozmiar nominalny	EAN numer produktu	Pakowanie w szt.		Cena z VAT [ZŁ/szt.]
				
<b>180</b>	002433	100	12 000	<b>2,60</b>
<b>240</b>	002440	100	12 000	<b>3,10</b>
<b>280</b>	002457	100	12 000	<b>3,30</b>



## WKRĘT KOMBI TORX M10 P-POB-ZT/SZ

Rozmiar nominalny	EAN numer produktu	Pakowanie w szt.		Cena z VAT [ZŁ/szt.]
				
<b>140</b>	002587	50	10 400	<b>2,80</b>
<b>180</b>	002594	50	10 400	<b>3,40</b>

## KOLEK DO IZOLACJI M10

P-POB-HN IZOL



Rozmiar nominalny	EAN numer produktu	Pakowanie w szt.		Cena z VAT [ZŁ/szt.]
<b>M10 x 96</b>	001207	25	2 625	<b>16,60</b>

## KOLEK IZOLACYJNY KOŃCÓWKA CEGŁA BEZ IZOLACJI P-POB-HN WDVS140 M10



Rozmiar nominalny	EAN numer produktu	Pakowanie w szt.		Cena z VAT [ZŁ/szt.]
<b>140</b>	144843	1/5	750	<b>29,50</b>

## KOLEK IZOLACYJNY KOŃCÓWKA DO CEGŁY Z IZOLACJĄ P-POB-HN WDVS300 M10



Rozmiar nominalny	EAN numer produktu	Pakowanie w szt.		Cena z VAT [ZŁ/szt.]
<b>300</b>	144850	1/5	500	<b>48,00</b>

## PLATFORMA UNI ZE STALI NIERDZEWNEJ DO MOCOWANIA OB M10 P-POB-HN PLAT M10



Rozmiar nominalny	EAN numer produktu	Pakowanie w szt.		Cena z VAT [ZŁ/szt.]
<b>M10</b>	144836	25/500	5 000	<b>20,60</b>

## PRĘT GWINTOWANY M10

P-POB-ZT



Rozmiar nominalny	EAN numer produktu	Pakowanie w szt.		Cena z VAT [Zł/szt.]
60	002556	100	20 800	1,20
100	002563	100	15 600	1,80
150	002570	50	10 400	3,40

## STOPKA OBEJMY RURY SPUSTOWEJ M10

P-POB-ZT MP



Rozmiar nominalny	EAN numer produktu	Pakowanie w szt.		Cena z VAT [Zł/szt.]
80 x 30	002518	25	5 200	7,10

## NAKLADKA DO SZTYFTU DO OBEJMY

P-POB-HT AKG



Rozmiar nominalny	EAN numer produktu	Pakowanie w szt.		Cena z VAT [Zł/szt.]
29 x 13	002280	50	16 800	1,50
29 x 13	002211	50	16 800	1,50
29 x 13	002235	50	16 800	1,50
29 x 13	002266	50	16 800	1,50
29 x 13	002242	50	16 800	1,50
29 x 13	002228	50	16 800	1,50
29 x 13	002273	50	16 800	1,50
29 x 13	002259	50	16 800	1,50
29 x 13	002297	50	16 800	1,50



## REWIZJA RURY SPUSTOWEJ

TZ-TZZV



Rozmiar nominalny	EAN numer produktu	Pakowanie w szt.		Cena z VAT [ZŁ/szt.]
80	035011	6	180	65,20
100	035028	5	150	80,00
120	035035	3	90	102,10

## REWIZJA RURY SPUSTOWEJ Z SITEM

TZ-TZZVS



Rozmiar nominalny	EAN numer produktu	Pakowanie w szt.		Cena z VAT [ZŁ/szt.]
80	034984	6	180	80,00
100	034991	5	150	91,60
120	035004	3	90	153,80

TYTAN-CYNK

## ZBIORNIK NA WODĘ + WĄŻ PLASTIKOWY

TZ-TZZVHA



Rozmiar nominalny	EAN numer produktu	Pakowanie w szt.		Cena z VAT [ZŁ/szt.]
80	001450	1	60	369,00
120	001474	1	60	608,90

## ŁAPACZ WODY Z WĘŻEM I PRZYCISKIEM

TZ-TZZVHAG



Rozmiar nominalny	EAN numer produktu	Pakowanie w szt.		Cena z VAT [ZŁ/szt.]
100	001467	1	60	387,50



## OCYNKOWANA STAL RURA OCHRONNA Z REWIZYJNYM OTWÓREM P-POZR

Rozmiar nominalny	Długość w m	EAN numer produktu	Pakowanie w szt.		Cena z VAT [ZŁ/szt.]
80	1,0	009708	1	70	369,00
100	1,0	009715	1	60	276,80
100	1,5	009722	1	60	547,40



## OCYNKOWANA STAL RURA OCHRONNA Z REWIZYJNYM OTWÓREM P-POZR

Rozmiar nominalny	Długość w m	EAN numer produktu	Pakowanie w szt.		Cena z VAT [ZŁ/szt.]
120	1,0	009739	1	40	645,80
120	1,5	009746	1	40	879,50

TYTAN-CYNK



## OBEJMA Z GUMĄ OCHRONNĄ M10 P-POB-OZR

Rozmiar nominalny	EAN numer produktu	Pakowanie w szt.		Cena z VAT [ZŁ/szt.]
80	002525	25	1 250	9,50
100	002532	25	1 250	12,30
120	002549	20	1 000	13,80



