



ODKVAPOVÝ SYSTÉM POLKRUHOVÝ



**CENNÍK
2024**



POWERFUL PARTNER FOR YOUR ROOF

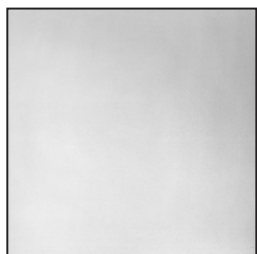

Titán-zinkový
materiál | 3



Žraby | 6



Dilatácie | 8



Žraby
príslušenstvo | 10



Háky | 11



Rohy | 12



Čelá | 12



Kotlíky | 13



Kolená | 17



Zvodové
rúry | 18

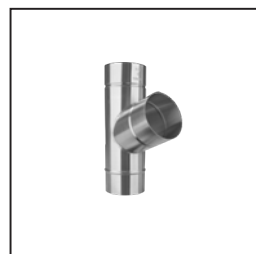

Zvodové rúry
príslušenstvo | 20



Objímky | 21

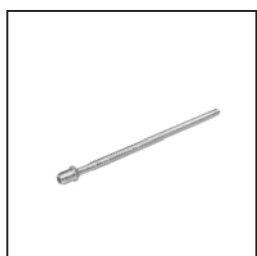

Objímky
príslušenstvo | 22



Zachytávače
vody | 25



Ochranné
zvodové rúry | 26

POLKRUHOVÝ ODKVAPOVÝ SYSTÉM

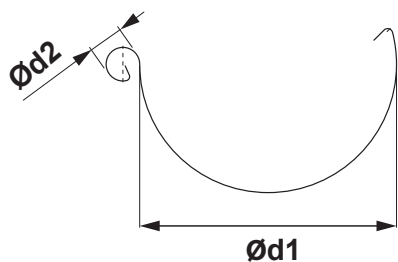

ROZMERY STREŠNÝCH ŽLABOV

(rozmery a rozmerové tolerancie podľa EN 612)

Rozvinutá šírka (mm)	200	250	280	333	400	500
Ød1	80	105	127	153	192	250
Ød2	16	18	18	20	22	22

ZVÁRANÉ TIG

VNÚTORNÝ FALZ

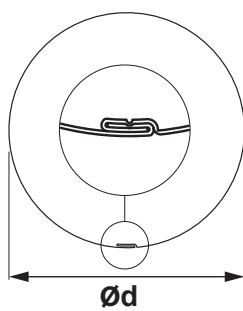
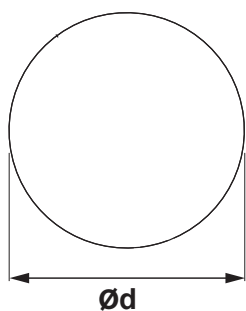

ROZMERY STREŠNÝCH ZVODOV

(rozmery a rozmerové tolerancie podľa EN 612)

Rozmery	60	80	100	120	VNÚTORNÝ FALZ 150
Menovitá veľkosť Ød (mm)	60	80	100	120	150

ROZMERY STREŠNÝCH HÁKOV

(rozmery a rozmerové tolerancie podľa EN 612)

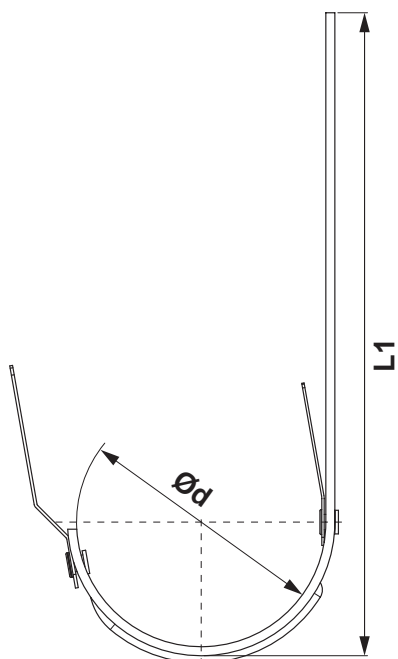

Rozmery (mm)	L1	Ød
200	290	80
250	310	105
280	345	127
333 – 550	385	153
333 – 610	445	153
400	400	192

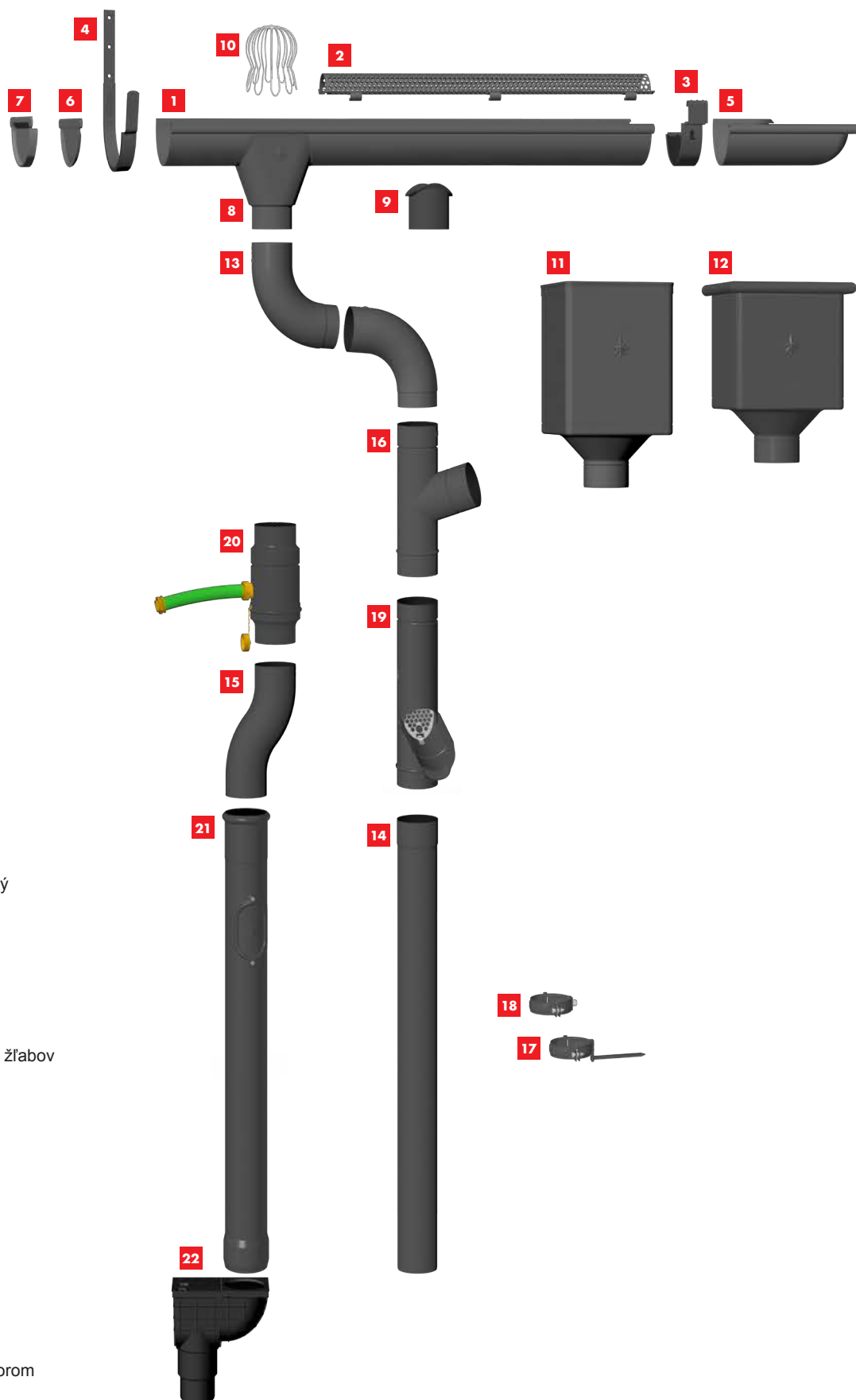

- 1** Strešný žľab polkruhový
- 2** Mriežka zachytávača nečistôt
- 3** Spojka strešného žľabu
- 4** Strešný žľabový hák obaloovaný
- 5** Žľabový roh vonkajší
- 6** Žľabové čelo polkruhové
- 7** Žľabové čelo s gumou
- 8** Žľabový kotlík
- 9** Strešné žľabové hrdlo
- 10** Zachytávač nečistôt strešných žľabov
- 11** Kotlík zberný DESIGN
- 12** Kotlík zberný KUBICKÝ
- 13** Zvodové koleno
- 14** Zvodová rúra
- 15** Zvodové koleno odskokové
- 16** Zvodová odbočka
- 17** Zvodová objímka s hrotom
- 18** Zvodová objímka M10
- 19** Zachytávač vody+sitko
- 20** Zachytávač vody+hadica
- 21** Ochranná rúra s revíznym otvorom
- 22** Kanalizačná vpusť priama





TITÁN
ZINOK

TITÁN – ZINOK



STREŠNÝ ŽĽAB POLKRUHOVÝ [s=0,65 mm]

TZ-TZZ

Menovitá veľkosť	Dĺžka v m	EAN číslo výrobku	Balenie v m		Cena [€/m]	
					Bez DPH	S DPH
200	3,0	047939	15	1 200	7,75	9,30
250	2,0	047946	10	480	7,40	8,88
250	3,0	047960	15	720	6,95	8,34
250	4,0	047984	20	960	6,95	8,34
250	5,0	047991	25	1 200	6,95	8,34
250	6,0	048004	30	1 440	6,95	8,34
280	2,0	048028	10	420	8,20	9,84
280	3,0	048042	15	630	7,75	9,30
280	4,0	048066	20	840	7,75	9,30
280	5,0	048080	25	1 050	7,75	9,30
280	6,0	048097	30	1 260	7,75	9,30
333	2,0	048103	10	330	9,10	10,92
333	3,0	048127	15	495	8,70	10,44
333	4,0	048141	20	660	8,70	10,44
333	5,0	048165	25	825	8,70	10,44
333	6,0	048196	30	990	8,70	10,44
400	4,0	048219	20	540	12,00	14,40
400	6,0	048233	30	810	12,00	14,40





TITÁN-ZINOK



STREŠNÝ ŽĽAB POLKRUHOVÝ [s=0,70 mm]

TZ-TZZ



Menovitá veľkosť	Dĺžka v m	EAN číslo výrobku	Balenie v m		Cena [€/m]	
					Bez DPH	S DPH
500 *	4,0	048257	20	–	22,90	27,48

* Výroba na objednávku



STREŠNÝ ŽĽAB POLKRUHOVÝ [s=0, 60 mm]

TZ-TZZ



Menovitá veľkosť	Dĺžka v m	EAN číslo výrobku	Balenie v m		Cena [€/m]	
					Bez DPH	S DPH
250 *	3,0	047953	15	720	7,25	8,70
250 *	4,0	047977	20	960	7,25	8,70
333 *	3,0	048110	15	495	9,50	11,40
333 *	4,0	048134	20	660	9,50	11,40
333 *	5,0	048158	25	825	9,50	11,40
333 *	6,0	048189	30	990	9,50	11,40

* Výroba na objednávku



NÁSTREŠNÝ ŽĽAB SAMRÍNOVÝ

TZ-TZZS

Menovitá veľkosť	Dĺžka v m	EAN číslo výrobku	Balenie v m		Cena [€/m]	
					Bez DPH	S DPH
650	4,0	000439	4	200	31,10	37,32

STREŠNÝ DILATAČNÝ ŽĽAB POLKRUHOVÝ

TZ-TZZDI

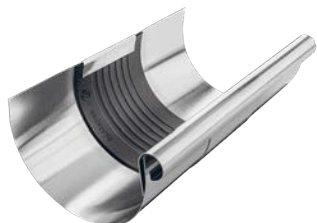

Menovitá veľkosť	EAN číslo výrobku	Balenie v ks		Cena [€/ks]	
				Bez DPH	S DPH
250/260	082688	3	360	13,50	16,20
280/260	082695	3	360	13,70	16,44
333/260	082701	5	200	13,70	16,44
400/260	082718	5	200	17,60	21,12

DILATAČNÝ ŽĽAB NÁSTREŠNÝ – SAMRÍNA

TZ-TZZSDI



Menovitá veľkosť	EAN číslo výrobku	Balenie v ks		Cena [€/ks]	
				Bez DPH	S DPH
670/260	082725	1	40	36,50	43,80

DILATAČNÝ PÁS

TZ-TZZDIP



Menovitá veľkosť	Dĺžka v m	EAN číslo výrobku	Balenie v m		Cena [€/m]	
					Bez DPH	S DPH
260	3,0	028020	3	120	45,00	54,00
260	6,0	028037	6	240	45,00	54,00

POUŽITIE DILATAČNÉHO ŽĽABU A DILATAČNÉHO PÁSU

DILATAČNÝ ŽĽAB

Príklad montáže: Pododkvapový žľab o rozvinutej šírke do 500 mm. Dilatačný žľab musí byť namontovaný v rozostupe 15 m. Pre vonkajší roh a začiatok žľabu platí polovica štandardnej hodnoty: maximálne 7,5 m. Pre vnútorný roh platí štvrtina štandardnej hodnoty: maximálne 3,75 m. Pre ostatné materiály a rozmery: pozri tabuľku nižšie. Rohy sa vždy počítajú ako pevné body.

DILATAČNÝ PÁS

Vnútoraná inštalácia: na žľaby uchytené bez lepenia na podklad, strechy s neštandardným profilom a oplechovania muríva

STREŠNÉ: POLKRUHOVÉ DILATAČNÉ ŽĽABY

Rozvinutá šírka žľabu	Hliník	Pozink, Titán-zinok, Meď, Nerez
< 500	12	15
> 500	8	10

STREŠNÝ: DILATAČNÝ PÁS

Rozvinutá šírka žľabu	Hliník	Pozink, Titán-zinok, Meď, Nerez
< 500	8	10
> 500	6	8

Pre vonkajší roh alebo začiatok žľabu platí polovica štandardnej hodnoty. Pre vnútorný roh platí jedna štvrtina štandardnej hodnoty.

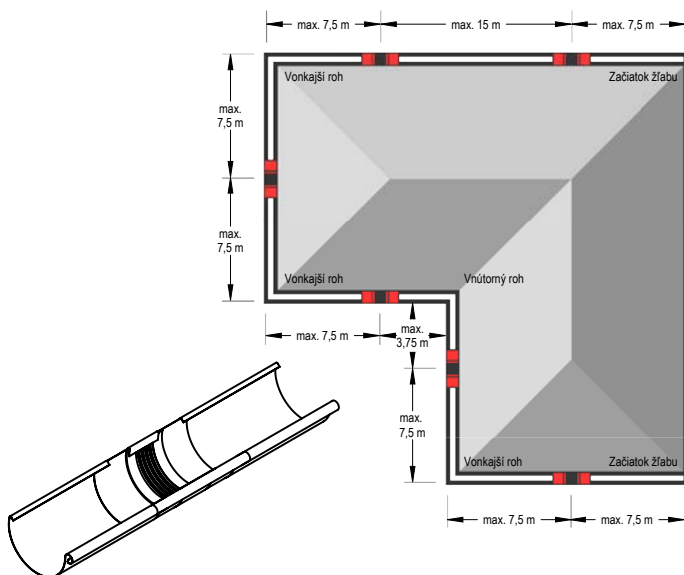

Poznámka k montáži dilatačného žľabu.

Pri montáži pomocou spájkovania najprv stredný gumový diel prekryte mokrou handričkou (aby nedošlo k prestupu tepla do stredného gumového dielu). Musí sa dodržať minimálna vzdialenosť 6 cm od strednej gumovej časti. V každom prípade sa treba vyhýbať kontaktu gumeného dielu s otvoreným plameňom.

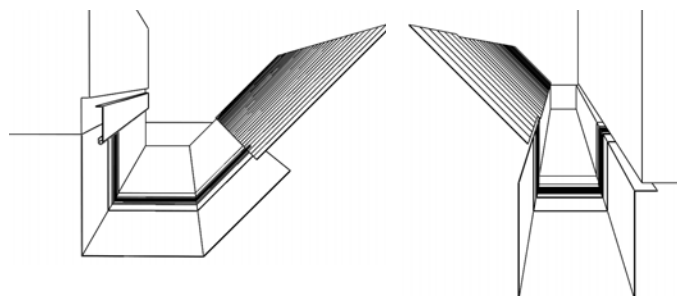

Poznámka k montáži dilatačného pásu.

Pri ohýbaní a montáži dilatačných prvkov sa uistite, že:

- Ohýbacie čeluste majú rádius minimálne 2 mm.
- Pre hrúbku plechu od 1 mm musí byť dodržaný polomer ohybu minimálne 5 mm.
- Ohýbacie čeluste musia byť pri ohýbaní nastavené na hrúbku strednej gumovej časti 3 až 4 mm, aby sa zabránilo strihaciemu efektu – poškodeniu gumeného dielu.
- Gumová stredná časť nesmie byť počas ohýbania stlačená alebo poškodená. Preto by mal byť použitý hliníkový plechový pás 2 až 5 mm (hrubý) ohnutý tak, aby mohol byť pripevnený ako ochrana na ohýbacie čeluste. Tým sa dosiahne väčší polomer ohybu a zabráni sa porušeniu gumovej strednej časti.



HLINÍKOVÁ MRIEŽKA ZACHYTÁVAČA NEČISTÔT

W-WZNL M

Menovitá veľkosť	Dĺžka v m	EAN číslo výrobku	Balenie v ks		Cena [€/ks]	
					Bez DPH	S DPH
333	2,0	064905	25	300	25,50	30,60

PVC MRIEŽKA ZACHYTÁVAČA LÍSTIA

SD-ZNL MRIEŽKA

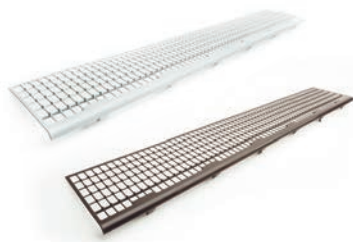

Menovitá veľkosť	Dĺžka v m	EAN číslo výrobku	Balenie v ks		Cena [€/ks]	
					Bez DPH	S DPH
171	1,0	008473	30	450	4,50	5,40
171	1,0	008466	30	450	4,50	5,40

PVC MRIEŽKA ZACHYTÁVAČA LÍSTIA

SD-ZNL N

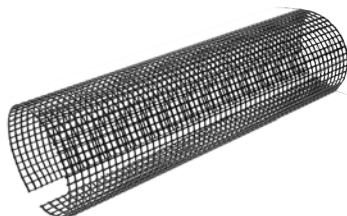



Menovitá veľkosť	Dĺžka v m	EAN číslo výrobku	Balenie v ks		Cena [€/ks]	
					Bez DPH	S DPH
250	3,0	008480	10	400	23,90	28,68
280-333	3,0	008497	10	400	24,00	28,80





SPOJKA STREŠNÉHO ŽLABU

TZ-TZSPZ



Menovitá veľkosť	EAN číslo výrobku	Balenie v ks		Cena [€/ks]	
				Bez DPH	S DPH
250 *	102454	5	600	V PROCESE TESTOVANIA	
280 *	102461	5	600	V PROCESE TESTOVANIA	
333 *	102478	5	600	V PROCESE TESTOVANIA	

* Výroba na objednávku



ŽLABOVÝ HÁK OBALOVANÝ

TZ-TZHOB



Menovitá veľkosť	Materiál	EAN číslo výrobku	Balenie v ks		Cena [€/ks]	
					Bez DPH	S DPH
200/380	25/6	032805	10	1 000	4,40	5,28
250/430	25/6	032812	10	1 000	3,50	4,20
280/480	25/6	032829	10	1 000	3,80	4,56
333/550	25/6	032836	10	1 000	4,00	4,80
333/610	25/6	032843	10	1 000	4,75	5,70
400/650	25/6	032850	10	500	6,35	7,62

TITÁN-ZINOK



NÁSTREŠNÝ HÁK SAMRÍNOVÝ SPEVNENÝ OBALOVANÝ



TZ-TZHOBSSN

Menovitá veľkosť	Materiál	EAN číslo výrobku	Balenie v ks		Cena [€/ks]	
					Bez DPH	S DPH
4	25/6	000910	15	300	17,30	20,76

ŽLABOVÝ ROH VONKAJŠÍ

TZ-TZRA





Menovitá veľkosť	EAN číslo výrobku	Balenie v ks		Cena [€/ks]	
				Bez DPH	S DPH
200	000811	5	150	15,00	18,00
250	000828	5	150	15,00	18,00
280	000835	5	150	16,60	19,92
333	000842	5	150	16,60	19,92
400	000859	5	150	32,90	39,48

ŽLABOVÝ ROH VNÚTORNÝ

TZ-TZRI





Menovitá veľkosť	EAN číslo výrobku	Balenie v ks		Cena [€/ks]	
				Bez DPH	S DPH
200	000866	5	150	15,00	18,00
250	000873	5	150	15,00	18,00
280	000880	5	150	16,60	19,92
333	000897	5	150	16,60	19,92
400	000903	5	150	32,90	39,48

ŽLABOVÉ ČELO POLKRUHOVÉ

TZ-TZCL





Menovitá veľkosť	EAN číslo výrobku	Balenie v ks		Cena [€/ks]	
				Bez DPH	S DPH
200	001665	6/60	1 440	0,80	0,96
250	001672	50	4 500	0,70	0,84
280	001689	50	4 500	0,80	0,96
333	001696	50	4 500	0,95	1,14
400	001702	4/40	960	1,55	1,86

ŽLABOVÉ ČELO S GUMOU

TZ-TZCLG



Menovitá veľkosť	EAN číslo výrobku	Balenie v ks		Cena [€/ks]	
				Bez DPH	S DPH
250 *	004390	25	2 250	V PROCESE TESTOVANIA	
280 *	004406	25	2 250	V PROCESE TESTOVANIA	
333 *	004413	25	2 250	V PROCESE TESTOVANIA	

* Výroba na objednávku

ŽLABOVÝ KOTLÍK

TZ-TZKL



Menovitá veľkosť	EAN číslo výrobku	Balenie v ks		Cena [€/ks]	
				Bez DPH	S DPH
200/60	003775	20	600	8,70	10,44
250/60	003782	20	600	8,10	9,72
250/80	003799	20	600	6,50	7,80
280/80	003805	20	600	8,15	9,78
280/100	003812	20	600	7,50	9,00
333/80	003829	20	600	10,00	12,00
333/100	003836	20	600	8,20	9,84
333/120	003843	15	300	11,50	13,80
400/100	003850	15	300	16,00	19,20
400/120	003867	15	300	17,70	21,24
400/150	003874	15	300	21,00	25,20

TITÁN-ZINOK

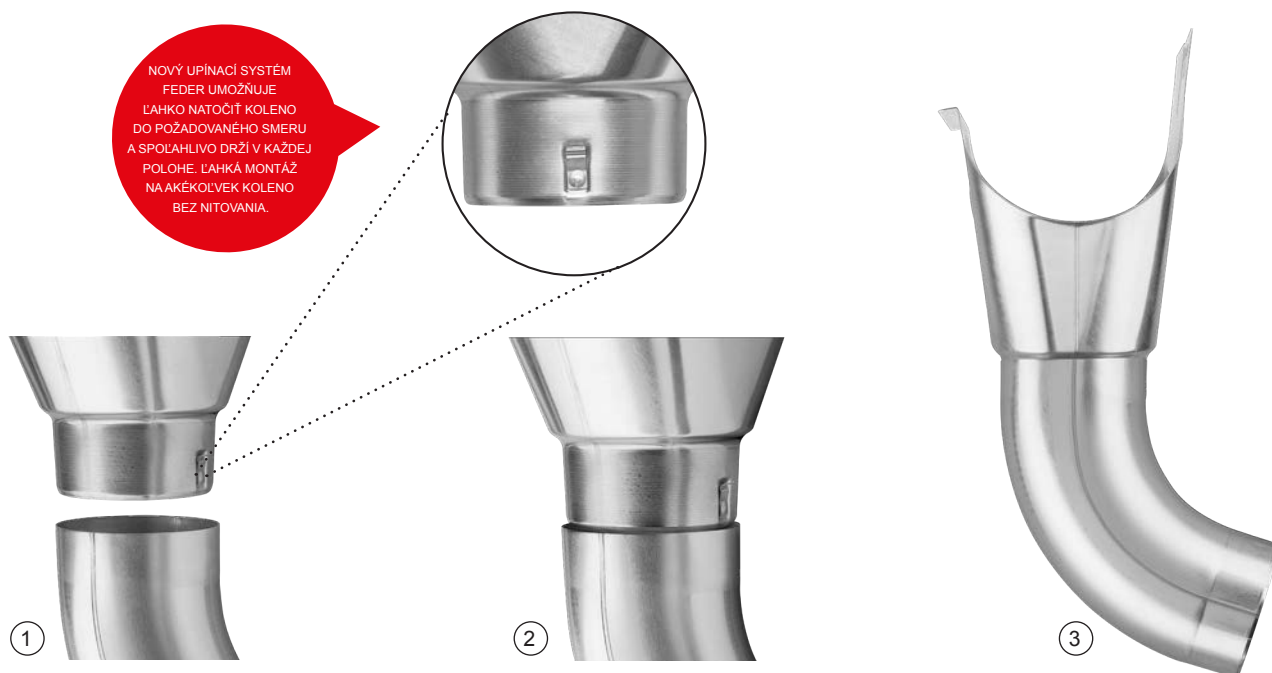

STREŠNÉ ŽĽABOVÉ HRDLO

TZ-TZHRD



Menovitá veľkosť	EAN číslo výrobku	Balenie v ks		Cena [€/ks]	
				Bez DPH	S DPH
80	102539	40	1 000	2,30	2,76
100	102546	25	1 000	2,60	3,12
120	102553	15	750	3,50	4,20

NEREZOVÝ ZACHYTÁVAČ NEČISTÔT STREŠNÝCH ŽĽABOV

N-NZN



Menovitá veľkosť	EAN číslo výrobku	Balenie v ks		Cena [€/ks]	
				Bez DPH	S DPH
60	001153	30	2 160	5,55	6,66
80	001160	20	1 440	5,60	6,72
100	001177	15	1 080	5,70	6,84
120	001184	10	720	6,20	7,44
150	001191	5	360	9,80	11,76



KOTLÍK ZBERNÝ DESIGN

TZ-TZKLZ DE



Menovitá veľkosť	EAN číslo výrobku	Balenie v ks		Cena [€/ks]	
				Bez DPH	S DPH
80	007834	2	36	65,00	78,00
100	007858	2	36	65,00	78,00
120	007872	2	36	66,00	79,20

KOTLÍK ZBERNÝ DESING EXZENTRICKÝ

TZ-TZKLZ DX



Menovitá veľkosť	EAN číslo výrobku	Balenie v ks		Cena [€/ks]	
				Bez DPH	S DPH
80 *	007896	2	36	75,00	90,00
100	007926	2	36	75,00	90,00
120	007957	2	36	76,50	91,80

* Výroba na objednávku

KOTLÍK ZBERNÝ KUBICKÝ

TZ-TZKLZ KU



Menovitá veľkosť	EAN číslo výrobku	Balenie v ks		Cena [€/ks]	
				Bez DPH	S DPH
80 *	007841	2	36	97,20	116,64
100	007865	2	36	97,20	116,64
120	007889	2	36	97,20	116,64

* Výroba na objednávku

KOTLÍK ZBERNÝ KUBICKÝ EXZENTRICKÝ

TZ-TZKLZ KX



Menovitá veľkosť	EAN číslo výrobku	Balenie v ks		Cena [€/ks]	
				Bez DPH	S DPH
80	007902	2	36	98,00	117,60
100	007933	2	36	98,00	117,60
120	007964	2	36	100,00	120,00

KOTLÍK ZBERNÝ KUBICKÝ EXZENTRICKÝ VÝTOK

TZ-TZKLZ KXV



Menovitá veľkosť	EAN číslo výrobku	Balenie v ks		Cena [€/ks]	
				Bez DPH	S DPH
80	007919	2	36	137,00	164,40
100	007940	2	36	137,00	164,40
120	007971	2	36	138,00	165,60

EPDM TESNIACA GUMA ZBERNÉHO KOTLÍKA

P-PKLZ T



Menovitá veľkosť	EAN číslo výrobku	Balenie v ks		Cena [€/ks]	
				Bez DPH	S DPH
IC 70-85	077103	5	600	4,00	4,80
IC 100-110	077110	5	600	4,10	4,92
IC 110-125	077097	5	600	4,20	5,04
PS 70-85	077134	5	600	4,50	5,40
PS 100-110	077141	5	600	4,90	5,88
PS 110-125	077127	5	600	5,00	6,00

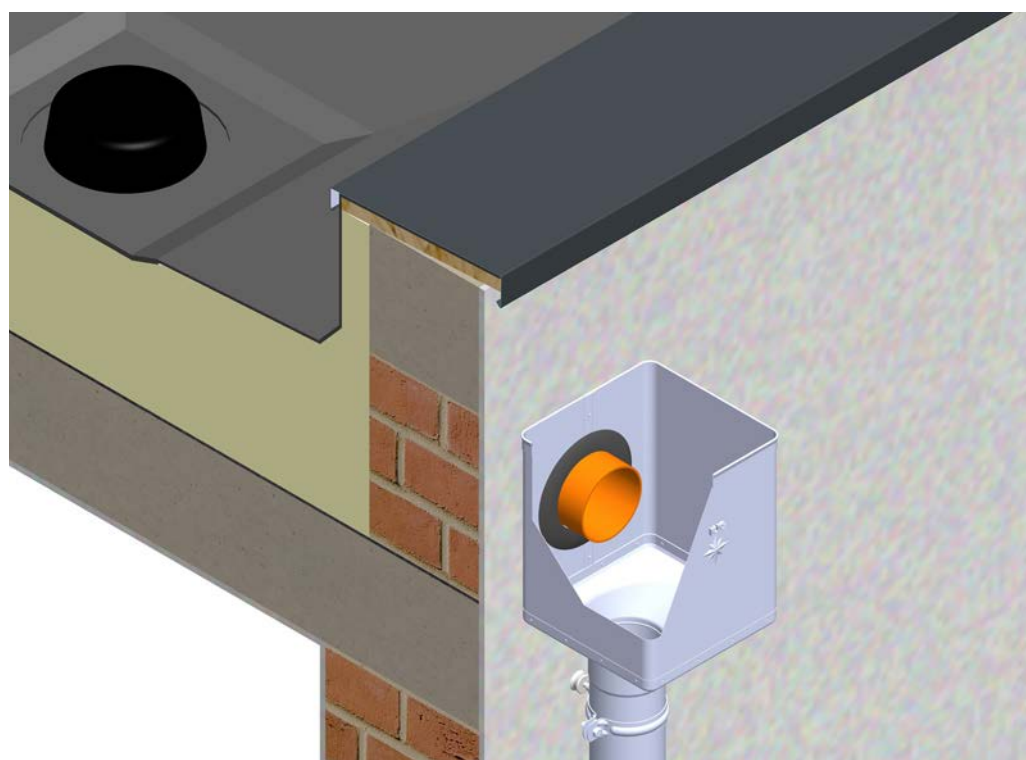

ZVODOVÉ KOLENO 72°

TZ-TZK



Menovitá veľkosť	EAN číslo výrobku	Balenie v ks		Cena [€/ks]	
				Bez DPH	S DPH
60	083081	25	600	6,10	7,32
80	083098	25	400	4,45	5,34
100	083111	25	300	5,20	6,24
120	083135	15	180	11,20	13,44
150	083159	5	90	39,00	46,80

ZVODOVÉ KOLENO RÁDIUS 85°

TZ-TZKR



Menovitá veľkosť	EAN číslo výrobku	Balenie v ks		Cena [€/ks]	
				Bez DPH	S DPH
80	083104	25	400	7,80	9,36
100	083128	25	300	8,30	9,96
120	083142	15	180	18,30	21,96



ZVODOVÉ KOLENO TUPÉ 40°

TZ-TZKT



Menovitá veľkosť	EAN číslo výrobku	Balenie v ks		Cena [€/ks]	
				Bez DPH	S DPH
80	083166	25	400	5,40	6,48
100	083173	25	300	6,90	8,28
120	083180	15	240	13,50	16,20

ZVODOVÁ RÚRA [s=0,65 mm]
TZ-TZZR

Menovitá veľkosť	Dĺžka v m	EAN číslo výrobku	Balenie v m		Cena [€/m]	
					Bez DPH	S DPH
60	2,0	047618	2	490	6,90	8,28
60	3,0	047625	3	735	6,90	8,28
80	1,0	047649	10	100	7,60	9,12
80	2,0	047663	2	250	7,30	8,76
80	3,0	047687	3	375	7,30	8,76
80	4,0	047694	4	500	7,30	8,76
80 *	5,0	047700	5	625	7,30	8,76
80 *	6,0	047717	6	750	7,30	8,76
100	1,0	047731	10	70	9,20	11,04
100	2,0	047755	2	160	8,90	10,68
100	3,0	047779	3	240	8,90	10,68
100	4,0	047793	4	320	8,90	10,68
100 *	5,0	047816	5	400	8,90	10,68
100 *	6,0	047823	6	480	8,90	10,68
120	1,0	047830	8	48	11,75	14,10
120	2,0	047847	2	120	11,30	13,56
120	3,0	047854	3	180	11,30	13,56
120	4,0	047878	4	240	11,30	13,56
120 *	5,0	047892	5	300	11,30	13,56
120 *	6,0	047908	6	360	11,30	13,56



* Výroba na objednávku





ZVODOVÁ RÚRA [s=0,70 mm]

TZ-TZZR



Menovitá veľkosť	Dĺžka v m	EAN číslo výrobku	Balenie v m		Cena [€/m]	
					Bez DPH	S DPH
150 ¹	4,0	047922	4	112	24,80	29,76

¹ Vnútrotný FALZ



ZVODOVÁ RÚRA [s=0, 60 mm]

TZ-TZZR



Menovitá veľkosť	Dĺžka v m	EAN číslo výrobku	Balenie v m		Cena [€/m]	
					Bez DPH	S DPH
80 *	1,0	047632	10	100	7,80	9,36
80 *	2,0	047656	2	250	7,80	9,36
80 *	3,0	047670	3	375	7,70	9,24
80 *	4,0	081742	4	500	7,70	9,24
80 *	5,0	081759	5	625	7,70	9,24
80 *	6,0	081766	6	750	7,70	9,24
100 *	1,0	047724	10	70	9,60	11,52
100 *	2,0	047748	2	160	9,60	11,52
100 *	3,0	047762	3	240	9,50	11,40
100 *	4,0	047786	4	320	9,50	11,40
100 *	5,0	047809	5	400	9,50	11,40
100 *	6,0	081773	6	480	9,50	11,40

* Výroba na objednávku



PLASTOVÝ ZVODOVÝ RUKÁV

SD-ZR FOLIA KJG

Rozmiar nominalny	Dĺžka v m	EAN číslo výrobku	Balenie v m		Cena [€/m]	
					Bez DPH	S DPH
60-150	100,0	139726	100	6 000	0,38	0,46



ZVODOVÉ KOLENO ODSKOKOVÉ

TZ-TZKO

Menovitá veľkosť	EAN číslo výrobku	Balenie v ks		Cena [€/ks]	
				Bez DPH	S DPH
80	047380	20	320	9,20	11,04
100	047397	20	240	11,20	13,44
120	047403	15	180	21,00	25,20

ZVODOVÁ ODBOČKA 72°

TZ-TZZO

Menovitá veľkosť	EAN číslo výrobku	Balenie v ks		Cena [€/ks]	
				Bez DPH	S DPH
80/80	102560	4	90	16,80	20,16
100/60	102577	4	120	18,00	21,60
100/80	102584	4	120	18,00	21,60
100/100	102591	4	120	18,00	21,60
120/80	102607	3	90	22,40	26,88
120/100	102614	3	90	22,40	26,88
120/120	102621	3	90	22,40	26,88
150/120 *	102638	2	36	36,40	43,68
150/150 *	102645	2	36	39,50	47,40

* Výroba na objednávku

ZVODOVÁ OBJÍMKA S HROTOM 150 mm

TZ-TZO



Menovitá veľkosť	EAN číslo výrobku	Balenie v ks		Cena [€/ks]	
				Bez DPH	S DPH
80	008503	25	1 000	3,00	3,60
100	008510	25	1 000	3,30	3,96
120	008527	25	1 000	3,50	4,20

ZVODOVÁ OBJÍMKA S HROTOM 200 mm

TZ-TZOD



Menovitá veľkosť	EAN číslo výrobku	Balenie v ks		Cena [€/ks]	
				Bez DPH	S DPH
80	008534	25	1 000	3,20	3,84
100	008541	25	1 000	3,45	4,14
120	008558	25	1 000	3,65	4,38

ZVODOVÁ OBJÍMKA S HROTOM 300 mm

TZ-TZODD



Menovitá veľkosť	EAN číslo výrobku	Balenie v ks		Cena [€/ks]	
				Bez DPH	S DPH
100	008572	20	800	3,70	4,44
120	008589	20	800	4,10	4,92

ZVODOVÁ OBJÍMKA M10

TZ-TZOB





Menovitá veľkosť	EAN číslo výrobku	Balenie v ks		Cena [€/ks]	
				Bez DPH	S DPH
60	000132	25	3 000	3,95	4,74
80	000149	25	3 000	3,00	3,60
100	000156	25	3 000	3,20	3,84
120	000163	25	3 000	3,70	4,44
150	000170	20	2 400	5,00	6,00



NEREZOVÁ SKRUTKA S PVC PODLOŽKOU M6x20



P-POB-NSK

Menovitá veľkosť	EAN číslo výrobku	Balenie v ks		Cena [€/ks]	
				Bez DPH	S DPH
M6 x 20 *	071675	1	–	0,15	0,18

* Výroba na objednávku

ZÁVITOVÝ HROT TORX M10

P-POB-HT



Menovitá veľkosť	EAN číslo výrobku	Balenie v ks		Cena [€/ks]	
				Bez DPH	S DPH
80	002464	100	40 000	1,00	1,20
140	002471	100	28 000	1,25	1,50
200	002488	100	20 000	1,55	1,86
250	002495	100	16 000	1,70	2,04
300	002501	100	11 200	1,70	2,04



TITÁN-ZINOK

HMOŽDINKA MODRÁ BEZ LAMELY M10



P-POB-HN DB

Menovitá veľkosť	EAN číslo výrobku	Balenie v ks		Cena [€/ks]	
				Bez DPH	S DPH
120	002426	100	25 000	0,40	0,48



HMOŽDINKA MODRÁ S LAMELOU M10



P-POB-HN DB

Menovitá veľkosť	EAN číslo výrobku	Balenie v ks		Cena [€/ks]	
				Bez DPH	S DPH
180	002433	100	12 000	0,42	0,50
240	002440	100	12 000	0,50	0,60
280	002457	100	12 000	0,53	0,64



KOMBISKRUTKA TORX M10

P-POB-ZT/SZ

Menovitá veľkosť	EAN číslo výrobku	Balenie v ks		Cena [€/ks]	
				Bez DPH	S DPH
140	002587	50	10 400	0,45	0,54
180	002594	50	10 400	0,55	0,66



NYLON IZOLAČNÁ HMOŽDINKA S OCHRANNOU KRYTKOU M10 P-POB-HN IZOL



Menovitá veľkosť	EAN číslo výrobku	Balenie v ks		Cena [€/ks]	
				Bez DPH	S DPH
M10 x 96	001207	25	2 625	2,70	3,24

IZOLAČNÁ HMOŽDINKA HROT TEHLA BEZ ZATEPLENIA P-POB-HN WDVS140 M10



Menovitá veľkosť	EAN číslo výrobku	Balenie v ks		Cena [€/ks]	
				Bez DPH	S DPH
140	144843	1/5	750	4,80	5,76

IZOLAČNÁ HMOŽDINKA HROT TEHLA ZATEPLENIE P-POB-HN WDVS300 M10



Menovitá veľkosť	EAN číslo výrobku	Balenie v ks		Cena [€/ks]	
				Bez DPH	S DPH
300	144850	1/5	500	7,80	9,36

NEREZOVÁ UNI PLATFORMA NA UCHYTENIE OB M10 P-POB-HN PLAT M10



Menovitá veľkosť	EAN číslo výrobku	Balenie v ks		Cena [€/ks]	
				Bez DPH	S DPH
M10	144836	25/500	5 000	3,35	4,02

ZÁVITOVÁ TYČ M10

P-POB-ZT



Menovitá veľkosť	EAN číslo výrobku	Balenie v ks		Cena [€/ks]	
				Bez DPH	S DPH
60	002556	100	20 800	0,20	0,24
100	002563	100	15 600	0,30	0,36
150	002570	50	10 400	0,55	0,66

MONTÁŽNA PLATŇA M10

P-POB-ZT MP



Menovitá veľkosť	EAN číslo výrobku	Balenie v ks		Cena [€/ks]	
				Bez DPH	S DPH
80 x 30	002518	25	5 200	1,15	1,38

GUMOVÁ FAREBNÁ KRYTKA HROTU OBJÍMKY

P-POB-HT AKG



Menovitá veľkosť	EAN číslo výrobku	Balenie v ks		Cena [€/ks]	
				Bez DPH	S DPH
29 x 13	002280	50	16 800	0,25	0,30
29 x 13	002211	50	16 800	0,25	0,30
29 x 13	002235	50	16 800	0,25	0,30
29 x 13	002266	50	16 800	0,25	0,30
29 x 13	002242	50	16 800	0,25	0,30
29 x 13	002228	50	16 800	0,25	0,30
29 x 13	002273	50	16 800	0,25	0,30
29 x 13	002259	50	16 800	0,25	0,30
29 x 13	002297	50	16 800	0,25	0,30



ZACHYTÁVAČ VODY

TZ-TZZV



Menovitá veľkosť	EAN číslo výrobku	Balenie v ks		Cena [€/ks]	
				Bez DPH	S DPH
80	035011	6	180	10,60	12,72
100	035028	5	150	13,00	15,60
120	035035	3	90	16,60	19,92

ZACHYTÁVAČ VODY+SITKO

TZ-TZZVS



Menovitá veľkosť	EAN číslo výrobku	Balenie v ks		Cena [€/ks]	
				Bez DPH	S DPH
80	034984	6	180	13,00	15,60
100	034991	5	150	14,90	17,88
120	035004	3	90	25,00	30,00

ZACHYTÁVAČ VODY+HADICA

TZ-TZZVHA



Menovitá veľkosť	EAN číslo výrobku	Balenie v ks		Cena [€/ks]	
				Bez DPH	S DPH
80	001450	1	60	60,00	72,00
120	001474	1	60	99,00	118,80

ZACHYTÁVAČ VODY S HADICOU A GOMBÍKOM

TZ-TZZVHAG



Menovitá veľkosť	EAN číslo výrobku	Balenie v ks		Cena [€/ks]	
				Bez DPH	S DPH
100	001467	1	60	63,00	75,60



POZINKOVANÁ OCHRANNÁ RÚRA S REVÍZNYM OTVOROM P-POZR

Menovitá veľkosť	Dĺžka v m	EAN číslo výrobku	Balenie v ks		Cena [€/ks]	
					Bez DPH	S DPH
80	1,0	009708	1	70	60,00	72,00
100	1,0	009715	1	60	45,00	54,00
100	1,5	009722	1	60	89,00	106,80



POZINKOVANÁ OCHRANNÁ RÚRA S REVÍZNYM OTVOROM P-POZR

Menovitá veľkosť	Dĺžka v m	EAN číslo výrobku	Balenie v ks		Cena [€/ks]	
					Bez DPH	S DPH
120	1,0	009739	1	40	105,00	126,00
120	1,5	009746	1	40	143,00	171,60

TITÁN-ZINOK



POZINKOVANÁ OBJÍMKA S REBROVOU GUMOU M10 P-POB-OZR

Menovitá veľkosť	EAN číslo výrobku	Balenie v ks		Cena [€/ks]	
				Bez DPH	S DPH
80	002525	25	1 250	1,55	1,86
100	002532	25	1 250	2,00	2,40
120	002549	20	1 000	2,25	2,70

