



# ODVODNI SISTEM POLUKRUŽNI



**CENOVNIK**

**2024**

PREPORUČENE PRODAJNE CENE



POWERFUL PARTNER FOR YOUR ROOF

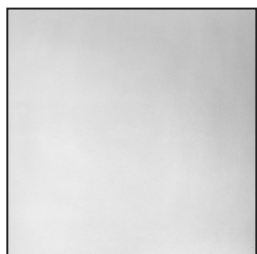

Titan cink  
materijal | 3



Oluk | 6



Dilatacija  
oluka | 8



Oluk  
oprema | 10



Kuka | 11



Krivina | 12



Završetak | 12



Kotlić | 13



Koleno | 17



Cev  
vertikala | 18

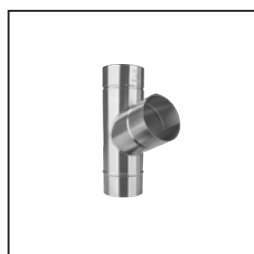

Cev vertikala  
oprema | 20



Šelna | 21

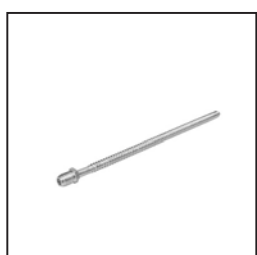

Šelna  
oprema | 22



Zadržać  
vode | 25



Zaštitna  
odvodna cev | 26

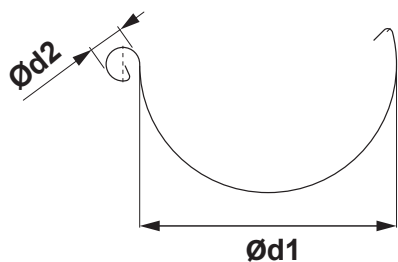

## DIMENZIJE KROVNIH OLUKA

(Dimenzije i tolerancije mera po EN 612)

Dimenzije (mm)	200	250	280	333	400	500
Ød1	80	105	127	153	192	250
Ød2	16	18	18	20	22	22

## ZAVAREN TIG

## UNUTRAŠNJA FALZ

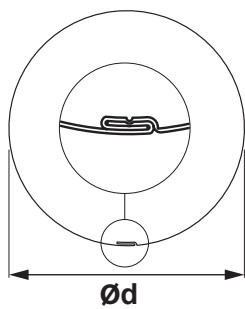
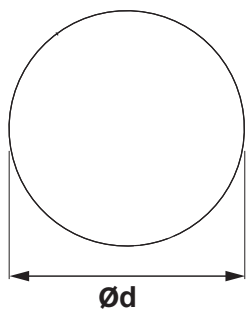

## DIMENZIJE CEVI

(Dimenzije i tolerancije mera po EN 612)

Dimenzije	60	80	100	120	UNUTRAŠNJA FALZ 150
Nominalna veličina Ød (mm)	60	80	100	120	150

## DIMENZIJE KROVNIH KUKA

(Dimenzije i tolerancije mera po EN 612)

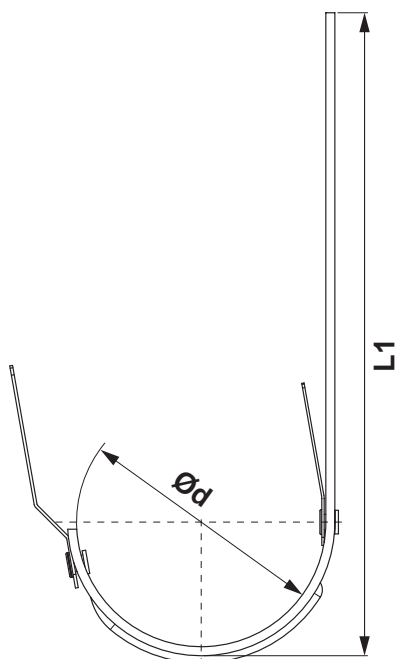

Dimenzije (mm)	L1	Ød
200	290	80
250	310	105
280	345	127
333 – 510	345	153
333 – 550	385	153
333 – 610	445	153
400	400	192

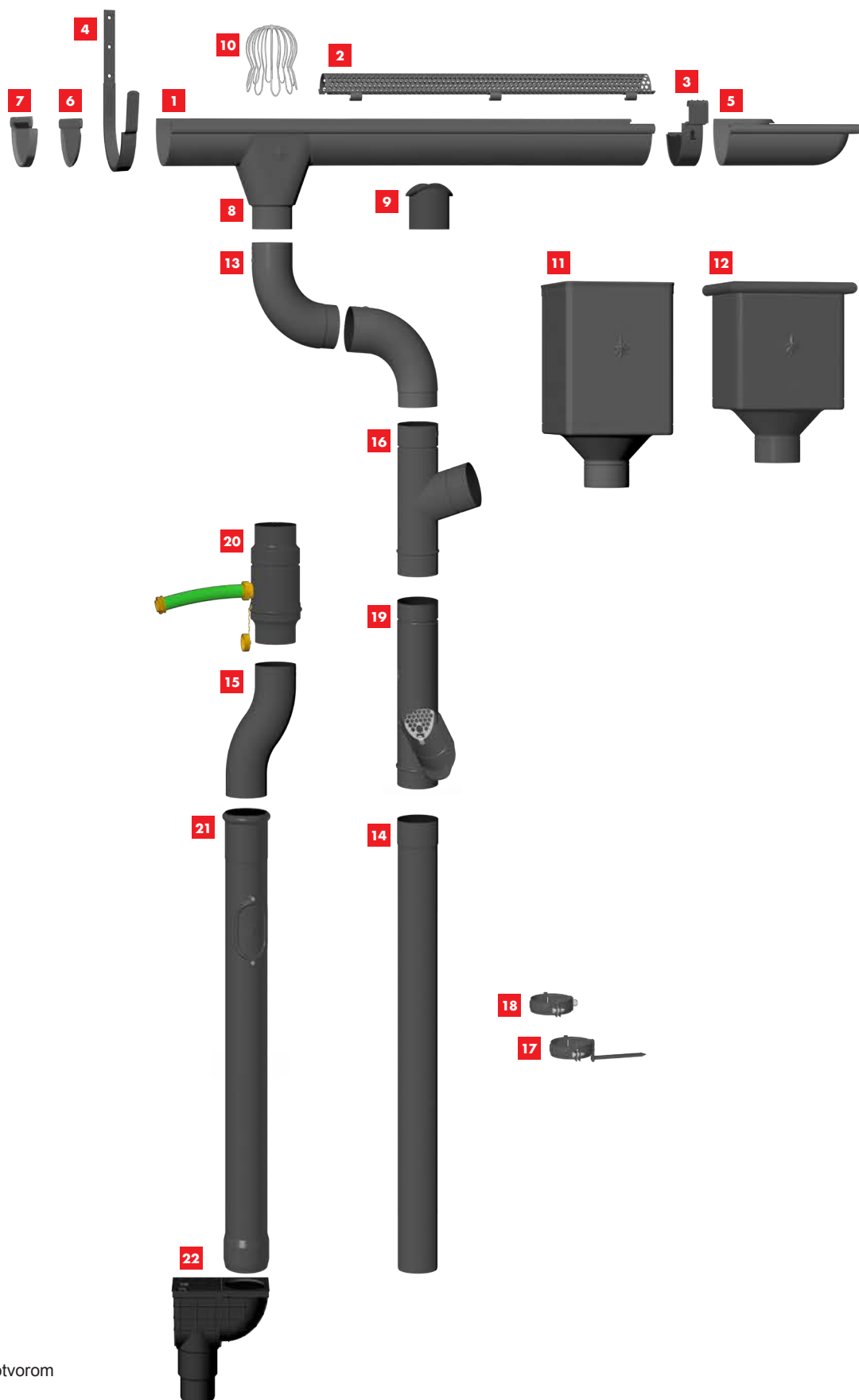

- 1** Oluk polukružni
- 2** Zadržáč nečistoća
- 3** Spojnica za oluk
- 4** Kuka
- 5** Krivina spoljašnja
- 6** Završetak
- 7** Završetak sa gumom
- 8** Kotlić
- 9** Štucna
- 10** Zadržáč smeća
- 11** Sabirni kotlić DESIGN
- 12** Sabirni kotlić KUBNI
- 13** Koleno
- 14** Cev vertikala
- 15** Koleno odskočno
- 16** Redukcija cevi
- 17** Šelna sa klinom
- 18** Šelna s navojem M10
- 19** Zadržáč vode sa sitom
- 20** Zadržáč vode sa crevom
- 21** Zaštitna odvodna cev sa rev. otvorom
- 22** Kanalizacioni odvod





# CINKOTIT



## OLUK POLUKRUŽNI [s=0,65 mm]

TZ-TZZ

Nominalna veličina	Dužina u m	EAN broj proizvoda	Pakovanje u m		Cena sa PDV-om [din/m]
					
<b>200</b>	3,0	047939	15	1 200	<b>1 116,00</b>
<b>250</b>	2,0	047946	10	480	<b>1 066,00</b>
<b>250</b>	3,0	047960	15	720	<b>1 001,00</b>
<b>250</b>	4,0	047984	20	960	<b>1 001,00</b>
<b>250</b>	5,0	047991	25	1 200	<b>1 001,00</b>
<b>250</b>	6,0	048004	30	1 440	<b>1 001,00</b>
<b>280</b>	2,0	048028	10	420	<b>1 181,00</b>
<b>280</b>	3,0	048042	15	630	<b>1 116,00</b>
<b>280</b>	4,0	048066	20	840	<b>1 116,00</b>
<b>280</b>	5,0	048080	25	1 050	<b>1 116,00</b>
<b>280</b>	6,0	048097	30	1 260	<b>1 116,00</b>
<b>333</b>	2,0	048103	10	330	<b>1 310,00</b>
<b>333</b>	3,0	048127	15	495	<b>1 253,00</b>
<b>333</b>	4,0	048141	20	660	<b>1 253,00</b>
<b>333</b>	5,0	048165	25	825	<b>1 253,00</b>
<b>333</b>	6,0	048196	30	990	<b>1 253,00</b>
<b>400</b>	4,0	048219	20	540	<b>1 728,00</b>
<b>400</b>	6,0	048233	30	810	<b>1 728,00</b>





CINKOTIT



## OLUK POLUKRUŽNI [s=0,70 mm]

TZ-TZZ



Nominalna veličina	Dužina u m	EAN broj proizvoda	Pakovanje u m		Cena sa PDV-om [din/m]
					
<b>500 *</b>	4,0	048257	20	–	<b>3 298,00</b>

\* Izrađuje se po narudžbi



## OLUK POLUKRUŽNI [s=0, 60 mm]

TZ-TZZ



Nominalna veličina	Dužina u m	EAN broj proizvoda	Pakovanje u m		Cena sa PDV-om [din/m]
					
<b>250 *</b>	3,0	047953	15	720	<b>1 044,00</b>
<b>250 *</b>	4,0	047977	20	960	<b>1 044,00</b>
<b>333 *</b>	3,0	048110	15	495	<b>1 368,00</b>
<b>333 *</b>	4,0	048134	20	660	<b>1 368,00</b>
<b>333 *</b>	5,0	048158	25	825	<b>1 368,00</b>
<b>333 *</b>	6,0	048189	30	990	<b>1 368,00</b>

\* Izrađuje se po narudžbi



## OLUK LEŽEĆI

TZ-TZZS

Nominalna veličina	Dužina u m	EAN broj proizvoda	Pakovanje u m		Cena sa PDV-om [din/m]
					
<b>650</b>	4,0	000439	4	200	<b>4 478,00</b>

\* Izrađuje se po narudžbi

## ILATACIJA POLUOKRUGLOG OLUKA

TZ-TZZDI

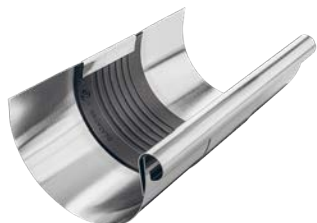

Nominalna veličina	EAN broj proizvoda	Pakovanje u kom		Cena sa PDV-om [din/kom]
<b>250/260</b>	082688	3	360	<b>1 944,00</b>
<b>280/260</b>	082695	3	360	<b>1 973,00</b>
<b>333/260</b>	082701	5	200	<b>1 973,00</b>
<b>400/260</b>	082718	5	200	<b>2 534,00</b>



## DILETACIJA ZA LEŽEĆI OLUK

TZ-TZZSDI

Nominalna veličina	EAN broj proizvoda	Pakovanje u kom		Cena sa PDV-om [din/kom]
<b>670/260</b>	082725	1	40	<b>5 256,00</b>



## DILATACIONA TRAKA

TZ-TZZDIP

Nominalna veličina	Dužina u m	EAN broj proizvoda	Pakovanje u m		Cena sa PDV-om [din/m]
<b>260</b>	3,0	028020	3	120	<b>6 480,00</b>
<b>260</b>	6,0	028037	6	240	<b>6 480,00</b>



## KORIŠTENJE DILATACIONOG ŽLEBA I DILATACIONE TRAKE

### DILATACIONI ŽLEB

**Primer montaže: Žleb pod oluk razvijene širine do 500 mm.** Dilatacioni žleb mora da bude montiran u rastojanjima 15 m. Za spoljašnji ugao i početak žleba važi polovina standardne vrednosti: maksimalno 7,5 m. Za unutrašnji ugao važi četvrtina standardne vrednosti: maksimalno 3,75 m. Za ostale materijale i dimenzije: vidi tabelu niže. Uglovi se uvek računaju kao čvrste tačke.

### POLUKRUŽNI DILATACIONI ŽLEBOVI

Razvijena širina žleba	Aluminijum	Pocink, Cinkotit, Bakar, Inox
< 500	12	15
> 500	8	10

### DILATACIONA TRAKA

**Unutrašnja instalacija:** na žlebove pričvršćene bez lepljenja na podlogu krova sa nestandardnim profilom i limenu oplatu zida.

### DILATACIONA TRAKA

Razvijena širina žleba	Aluminijum	Pocink, Cinkotit, Bakar, Inox
< 500	8	10
> 500	6	8

Za spoljašnji ugao i početak žleba važi polovina standardne vrednosti. Za unutrašnji ugao važi četvrtina standardne vrednosti.

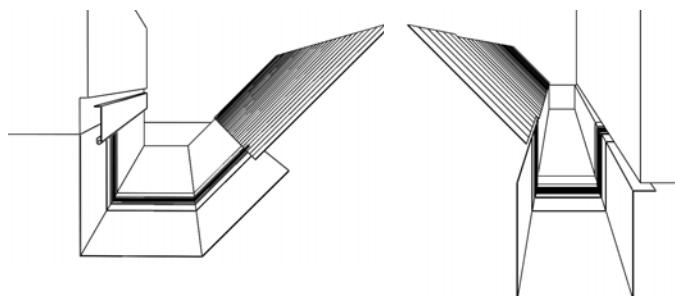
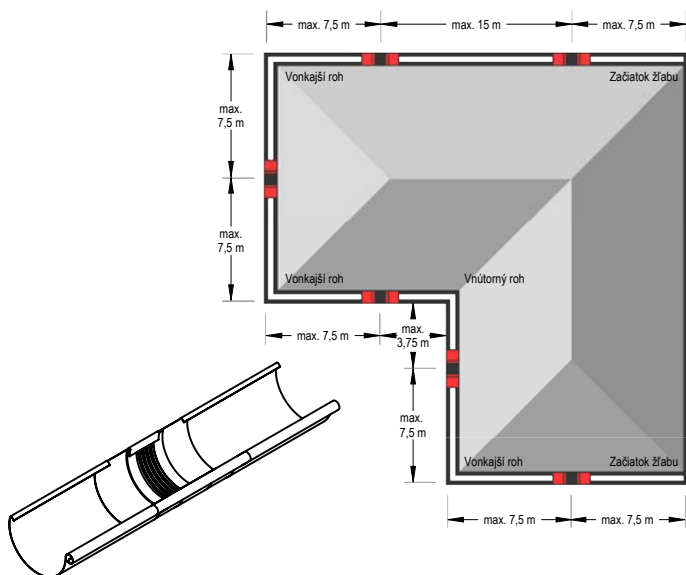

#### Napomena uz montažu dilatacione trake.

**Kada se savijaju i montiraju dilatacioni elementi, proverite sledeće:**

- Klešta za savijanje imaju radijus minimalno 2 mm.
- Za debljinu lima 1 mm se mora održati poluprečnik minimalno 5 mm.
- Klešta za savijanje moraju da za vreme savijanja budu podešena za debljinu 3 do 4 mm, kako bi se sprečio efekat sečenja – oštećenja gume.
- Srednji gumeni deo za vreme savijanja ne sme da bude pritisnut ili oštećen. Zbog toga treba koristiti aluminijumsku limenu traku debljine 2 do 5 mm, i saviti je tako, da se može pričvrstiti kao zaštita za klešta za savijanje. Time ćemo dobiti veći poluprečnik savijanja, i sprečiti da se ošteti srednji gumeni deo.

#### Napomena uz montažu dilatacionih žlebova.

Za vreme montaže lemljenjem, prvo pokrite srednji gumeni deo mokrom krpom (kako ne bi došlo do prenosa topline na srednji gumeni deo). Mora da se održava minimalna udaljenost 6 cm od srednjeg gumenog dela. U svakom slučaju je potrebno izbegavati kontakt gume i plamena.



## ALUMINIJUM ZADRŽAČ NEČISTOĆA

W-WZNL M

Nominalna veličina	Dužina u m	EAN broj proizvoda	Pakovanje u kom		Cena sa PDV-om [din/kom]
333	2,0	064905	25	300	3 672,00

## PVC SADRŽAČ LIŠĆA

SD-ZNL MRIEZKA

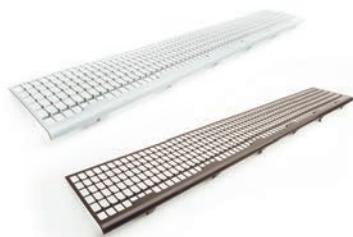

Nominalna veličina	Dužina u m	EAN broj proizvoda	Pakovanje u kom		Cena sa PDV-om [din/kom]
171	1,0	008473	30	450	648,00
171	1,0	008466	30	450	648,00

## PVC SADRŽAČ LIŠĆA

SD-ZNL N

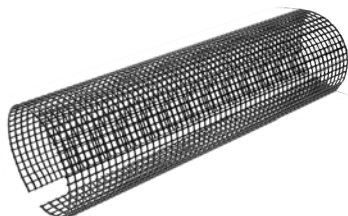



Nominalna veličina	Dužina u m	EAN broj proizvoda	Pakovanje u kom		Cena sa PDV-om [din/kom]
250	3,0	008480	10	400	3 442,00
280-333	3,0	008497	10	400	3 456,00





## SPOJNICA ZA OLUK

TZ-TZSPZ



Nominalna veličina	EAN broj proizvoda	Pakovanje u kom		Cena sa PDV-om [din/kom]
				
<b>250 *</b>	102454	5	600	<b>U PROCESU TESTIRANJA</b>
<b>280 *</b>	102461	5	600	<b>U PROCESU TESTIRANJA</b>
<b>333 *</b>	102478	5	600	<b>U PROCESU TESTIRANJA</b>

\* Izrađuje se po narudžbi



## KUKA

TZ-TZHOB



Nominalna veličina	Materijal	EAN broj proizvoda	Pakovanje u kom		Cena sa PDV-om [din/kom]
					
<b>200/380</b>	25/6	032805	10	1 000	<b>634,00</b>
<b>250/430</b>	25/6	032812	10	1 000	<b>504,00</b>
<b>280/480</b>	25/6	032829	10	1 000	<b>547,00</b>
<b>333/550</b>	25/6	032836	10	1 000	<b>576,00</b>
<b>333/610</b>	25/6	032843	10	1 000	<b>684,00</b>
<b>400/650</b>	25/6	032850	10	500	<b>914,00</b>

CINKOTIT



## KUKA ZA LEŽEĆI OLUK OJAČANA

TZ-TZHOBSSN

Nominalna veličina	Materijal	EAN broj proizvoda	Pakovanje u kom		Cena sa PDV-om [din/kom]
					
<b>4</b>	25/6	000910	15	300	<b>2 491,00</b>

## KRIVINA SPOLJAŠNJA

TZ-TZRA



Nominalna veličina	EAN broj proizvoda	Pakovanje u kom		Cena sa PDV-om [din/kom]
200	000811	5	150	<b>2 160,00</b>
250	000828	5	150	<b>2 160,00</b>
280	000835	5	150	<b>2 390,00</b>
333	000842	5	150	<b>2 390,00</b>
400	000859	5	150	<b>4 738,00</b>

## KRIVINA UNUTRAŠNJA

TZ-TZRI



Nominalna veličina	EAN broj proizvoda	Pakovanje u kom		Cena sa PDV-om [din/kom]
200	000866	5	150	<b>2 160,00</b>
250	000873	5	150	<b>2 160,00</b>
280	000880	5	150	<b>2 390,00</b>
333	000897	5	150	<b>2 390,00</b>
400	000903	5	150	<b>4 738,00</b>

## ZAVRŠETAK

TZ-TZCL



Nominalna veličina	EAN broj proizvoda	Pakovanje u kom		Cena sa PDV-om [din/kom]
200	001665	6/60	1 440	<b>115,00</b>
250	001672	50	4 500	<b>101,00</b>
280	001689	50	4 500	<b>115,00</b>
333	001696	50	4 500	<b>137,00</b>
400	001702	4/40	960	<b>223,00</b>

## ZAVRŠETAK SA GUMOM

TZ-TZCLG





Nominalna veličina	EAN broj proizvoda	Pakovanje u kom		Cena sa PDV-om [din/kom]
250 *	004390	25	2 250	<b>U PROCESU TESTIRANJA</b>
280 *	004406	25	2 250	<b>U PROCESU TESTIRANJA</b>
333 *	004413	25	2 250	<b>U PROCESU TESTIRANJA</b>

\* Izrađuje se po narudžbi

## KOTLIĆ

TZ-TZKL



Nominalna veličina	EAN broj proizvoda	Pakovanje u kom		Cena sa PDV-om [din/kom]
				
<b>200/60</b>	003775	20	600	<b>1 253,00</b>
<b>250/60</b>	003782	20	600	<b>1 166,00</b>
<b>250/80</b>	003799	20	600	<b>936,00</b>
<b>280/80</b>	003805	20	600	<b>1 174,00</b>
<b>280/100</b>	003812	20	600	<b>1 080,00</b>
<b>333/80</b>	003829	20	600	<b>1 440,00</b>
<b>333/100</b>	003836	20	600	<b>1 181,00</b>
<b>333/120</b>	003843	15	300	<b>1 656,00</b>
<b>400/100</b>	003850	15	300	<b>2 304,00</b>
<b>400/120</b>	003867	15	300	<b>2 549,00</b>
<b>400/150</b>	003874	15	300	<b>3 024,00</b>

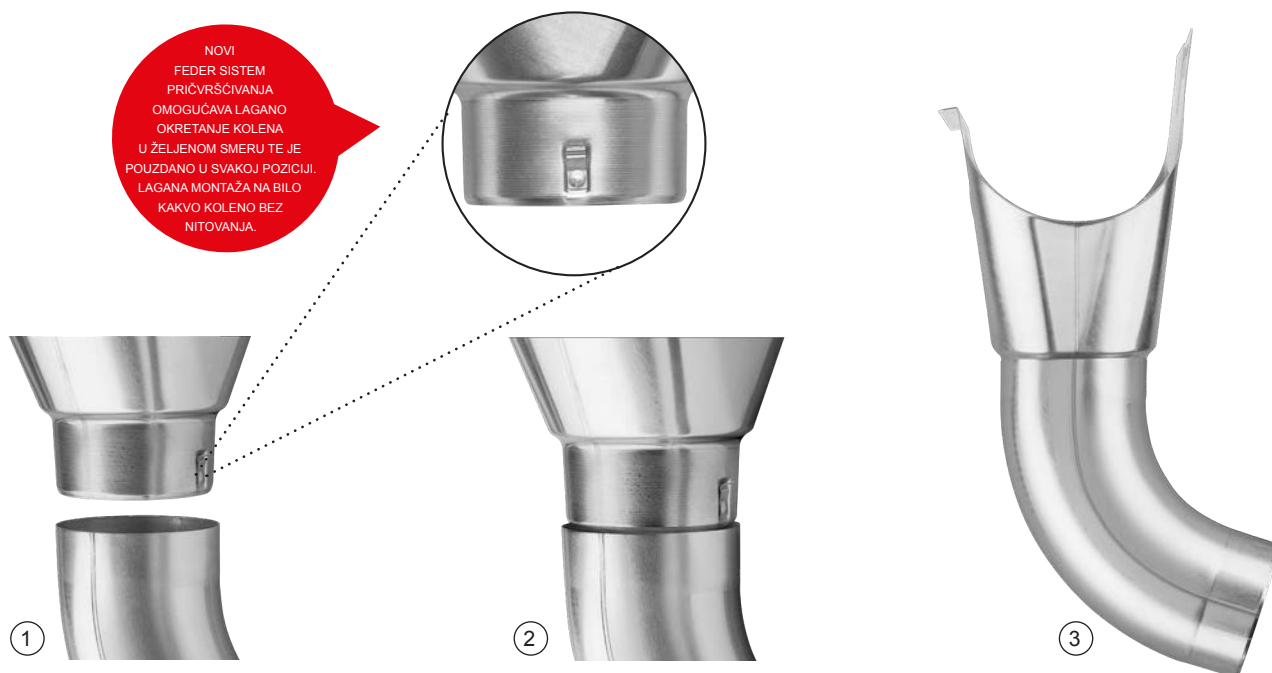

## ŠTUCNA

TZ-TZHRD



Nominalna veličina	EAN broj proizvoda	Pakovanje u kom		Cena sa PDV-om [din/kom]
80	102539	40	1 000	<b>331,00</b>
100	102546	25	1 000	<b>374,00</b>
120	102553	15	750	<b>504,00</b>

## ZADRŽAČ SMEĆA OD NERĐAJUĆEG ČELIKA

N-NZN



Nominalna veličina	EAN broj proizvoda	Pakovanje u kom		Cena sa PDV-om [din/kom]
60	001153	30	2 160	<b>799,00</b>
80	001160	20	1 440	<b>806,00</b>
100	001177	15	1 080	<b>821,00</b>
120	001184	10	720	<b>893,00</b>
150	001191	5	360	<b>1 411,00</b>





## SABIRNI KOTLIĆ DESIGN

TZ-TZKLZ DE

Nominalna veličina	EAN broj proizvoda	Pakovanje u kom		Cena sa PDV-om [din/kom]
80	007834	2	36	9 360,00
100	007858	2	36	9 360,00
120	007872	2	36	9 504,00



## SABIRNI KOTLIĆ DESIGN EKSCENTRIČAN

TZ-TZKLZ DX

Nominalna veličina	EAN broj proizvoda	Pakovanje u kom		Cena sa PDV-om [din/kom]
80 *	007896	2	36	10 800,00
100	007926	2	36	10 800,00
120	007957	2	36	11 016,00

\* Izrađuje se po narudžbi



## SABIRNI KOTLIĆ KUBNI

TZ-TZKLZ KU

Nominalna veličina	EAN broj proizvoda	Pakovanje u kom		Cena sa PDV-om [din/kom]
80 *	007841	2	36	13 997,00
100	007865	2	36	13 997,00
120	007889	2	36	13 997,00

\* Izrađuje se po narudžbi



## SABIRNI KOTLIĆ KUBNI EKSCENTRIČAN

TZ-TZKLZ KX

Nominalna veličina	EAN broj proizvoda	Pakovanje u kom		Cena sa PDV-om [din/kom]
80	007902	2	36	14 112,00
100	007933	2	36	14 112,00
120	007964	2	36	14 400,00



## SABIRNI KOTLIĆ KUBNI EKSCENTRIČAN SA ODVODOM



TZ-TZKLZ KXV

Nominalna veličina	EAN broj proizvoda	Pakovanje u kom		Cena sa PDV-om [din/kom]
80	007919	2	36	19 728,00
100	007940	2	36	19 728,00
120	007971	2	36	19 872,00

## GUMENA ZAPTIVKA ZA SABIRNI KOTLIĆ

P-PKLZ T



Nominalna veličina	EAN broj proizvoda	Pakovanje u kom		Cena sa PDV-om [din/kom]
				
<b>IC 70-85</b>	077103	5	600	<b>576,00</b>
<b>IC 100-110</b>	077110	5	600	<b>590,00</b>
<b>IC 110-125</b>	077097	5	600	<b>605,00</b>
<b>PS 70-85</b>	077134	5	600	<b>648,00</b>
<b>PS 100-110</b>	077141	5	600	<b>706,00</b>
<b>PS 110-125</b>	077127	5	600	<b>720,00</b>

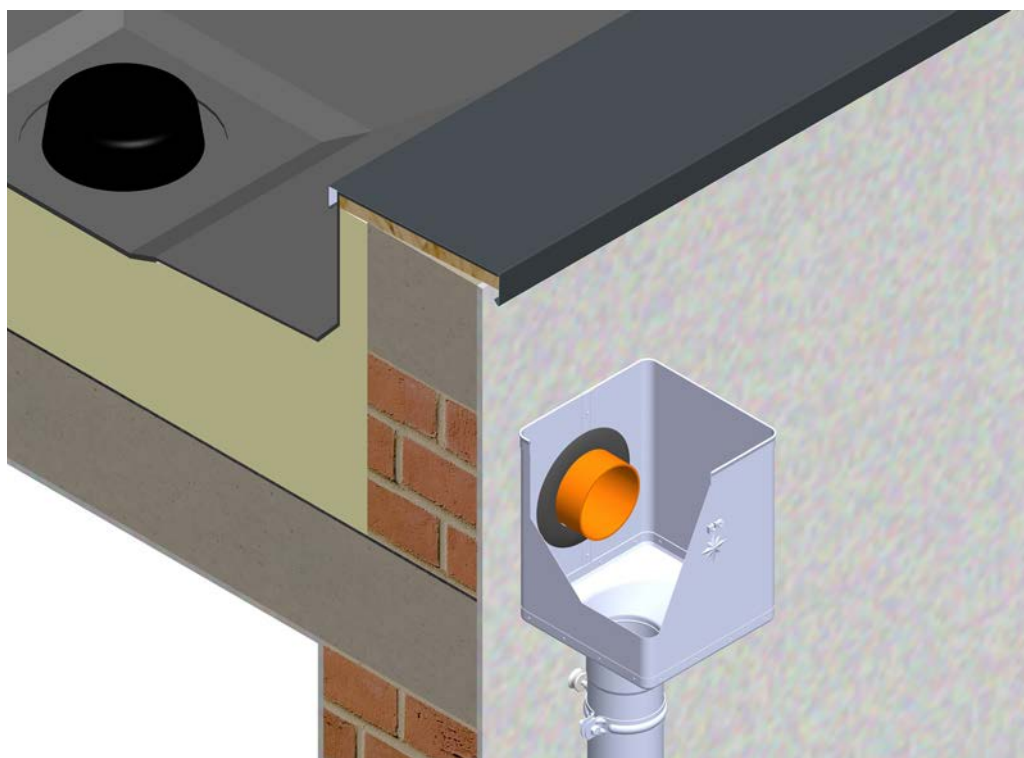



## KOLENO 72°

TZ-TZK



Nominalna veličina	EAN broj proizvoda	Pakovanje u kom		Cena sa PDV-om [din/kom]
60	083081	25	600	<b>878,00</b>
80	083098	25	400	<b>641,00</b>
100	083111	25	300	<b>749,00</b>
120	083135	15	180	<b>1 613,00</b>
150	083159	5	90	<b>5 616,00</b>

## KOLENO 85°

TZ-TZKR



Nominalna veličina	EAN broj proizvoda	Pakovanje u kom		Cena sa PDV-om [din/kom]
80	083104	25	400	<b>1 123,00</b>
100	083128	25	300	<b>1 195,00</b>
120	083142	15	180	<b>2 635,00</b>

## KOLENO 40°

TZ-TZKT





Nominalna veličina	EAN broj proizvoda	Pakovanje u kom		Cena sa PDV-om [din/kom]
80	083166	25	400	<b>778,00</b>
100	083173	25	300	<b>994,00</b>
120	083180	15	240	<b>1 944,00</b>

## CEV VERTIKALA [s=0,65 mm]

TZ-TZZR





Nominalna veličina	Dužina u m	EAN broj proizvoda	Pakovanje u m		Cena sa PDV-om [din/m]
					
<b>60</b>	2,0	047618	2	490	<b>994,00</b>
<b>60</b>	3,0	047625	3	735	<b>994,00</b>
<b>80</b>	1,0	047649	10	100	<b>1 094,00</b>
<b>80</b>	2,0	047663	2	250	<b>1 051,00</b>
<b>80</b>	3,0	047687	3	375	<b>1 051,00</b>
<b>80</b>	4,0	047694	4	500	<b>1 051,00</b>
<b>80 *</b>	5,0	047700	5	625	<b>1 051,00</b>
<b>80 *</b>	6,0	047717	6	750	<b>1 051,00</b>
<b>100</b>	1,0	047731	10	70	<b>1 325,00</b>
<b>100</b>	2,0	047755	2	160	<b>1 282,00</b>
<b>100</b>	3,0	047779	3	240	<b>1 282,00</b>
<b>100</b>	4,0	047793	4	320	<b>1 282,00</b>
<b>100 *</b>	5,0	047816	5	400	<b>1 282,00</b>
<b>100 *</b>	6,0	047823	6	480	<b>1 282,00</b>
<b>120</b>	1,0	047830	8	48	<b>1 692,00</b>
<b>120</b>	2,0	047847	2	120	<b>1 627,00</b>
<b>120</b>	3,0	047854	3	180	<b>1 627,00</b>
<b>120</b>	4,0	047878	4	240	<b>1 627,00</b>
<b>120 *</b>	5,0	047892	5	300	<b>1 627,00</b>
<b>120 *</b>	6,0	047908	6	360	<b>1 627,00</b>

\* Izrađuje se po narudžbi



## CEV VERTIKALA [s=0,70 mm]

TZ-TZZR



Nominalna veličina	Dužina u m	EAN broj proizvoda	Pakovanje u m		Cena sa PDV-om [din/m]
					
<b>150</b> <sup>1</sup>	4,0	047922	4	112	<b>3 571,00</b>

<sup>1</sup> Unutrašnja FALZ



## CEV VERTIKALA [s=0, 60 mm]

TZ-TZZR



Nominalna veličina	Dužina u m	EAN broj proizvoda	Pakovanje u m		Cena sa PDV-om [din/m]
					
<b>80 *</b>	1,0	047632	10	100	<b>1 123,00</b>
<b>80 *</b>	2,0	047656	2	250	<b>1 123,00</b>
<b>80 *</b>	3,0	047670	3	375	<b>1 109,00</b>
<b>80 *</b>	4,0	081742	4	500	<b>1 109,00</b>
<b>80 *</b>	5,0	081759	5	625	<b>1 109,00</b>
<b>80 *</b>	6,0	081766	6	750	<b>1 109,00</b>
<b>100 *</b>	1,0	047724	10	70	<b>1 382,00</b>
<b>100 *</b>	2,0	047748	2	160	<b>1 382,00</b>
<b>100 *</b>	3,0	047762	3	240	<b>1 368,00</b>
<b>100 *</b>	4,0	047786	4	320	<b>1 368,00</b>
<b>100 *</b>	5,0	047809	5	400	<b>1 368,00</b>
<b>100 *</b>	6,0	081773	6	480	<b>1 368,00</b>

\* Izrađuje se po narudžbi



## ODVODNI RUKAV



SD-ZR FOLIA KJG

Rozmiar nominalny	Dužina u m	EAN broj proizvoda	Pakovanje u m		Cena sa PDV-om [din/m]
					
<b>60-150</b>	100,0	139726	100	6 000	<b>55,00</b>





## KOLENO ODSKOČNO

TZ-TZKO

Nominalna veličina	EAN broj proizvoda	Pakovanje u kom		Cena sa PDV-om [din/kom]
				
<b>80</b>	047380	20	320	<b>1 325,00</b>
<b>100</b>	047397	20	240	<b>1 613,00</b>
<b>120</b>	047403	15	180	<b>3 024,00</b>

## REDUKCIJA CEVI 72°

TZ-TZZO

Nominalna veličina	EAN broj proizvoda	Pakovanje u kom		Cena sa PDV-om [din/kom]
				
<b>80/80</b>	102560	4	90	<b>2 419,00</b>
<b>100/60</b>	102577	4	120	<b>2 592,00</b>
<b>100/80</b>	102584	4	120	<b>2 592,00</b>
<b>100/100</b>	102591	4	120	<b>2 592,00</b>
<b>120/80</b>	102607	3	90	<b>3 226,00</b>
<b>120/100</b>	102614	3	90	<b>3 226,00</b>
<b>120/120</b>	102621	3	90	<b>3 226,00</b>
<b>150/120 *</b>	102638	2	36	<b>5 242,00</b>
<b>150/150 *</b>	102645	2	36	<b>5 688,00</b>

\* Izrađuje se po narudžbi



## ŠELNA SA KLINOM 150 mm

TZ-TZO



Nominalna veličina	EAN broj proizvoda	Pakovanje u kom		Cena sa PDV-om [din/kom]
80	008503	25	1 000	<b>432,00</b>
100	008510	25	1 000	<b>475,00</b>
120	008527	25	1 000	<b>504,00</b>

## ŠELNA SA KLINOM 200 mm

TZ-TZOD



Nominalna veličina	EAN broj proizvoda	Pakovanje u kom		Cena sa PDV-om [din/kom]
80	008534	25	1 000	<b>461,00</b>
100	008541	25	1 000	<b>497,00</b>
120	008558	25	1 000	<b>526,00</b>

## ŠELNA SA KLINOM 300 mm

TZ-TZODD



Nominalna veličina	EAN broj proizvoda	Pakovanje u kom		Cena sa PDV-om [din/kom]
100	008572	20	800	<b>533,00</b>
120	008589	20	800	<b>590,00</b>

## ŠELNA S NAVOJEM M10

TZ-TZOB





Nominalna veličina	EAN broj proizvoda	Pakovanje u kom		Cena sa PDV-om [din/kom]
60	000132	25	3 000	<b>569,00</b>
80	000149	25	3 000	<b>432,00</b>
100	000156	25	3 000	<b>461,00</b>
120	000163	25	3 000	<b>533,00</b>
150	000170	20	2 400	<b>720,00</b>

## INOX VIJKA ZA ŠELNE M6x20

P-POB-NSK





Nominalna veličina	EAN broj proizvoda	Pakovanje u kom		Cena sa PDV-om [din/kom]
				
<b>M6 x 20 *</b>	071675	1	–	<b>22,00</b>

\* Izrađuje se po narudžbi

## NAVOJ ZA ŠELNU TORX M10

P-POB-HT





Nominalna veličina	EAN broj proizvoda	Pakovanje u kom		Cena sa PDV-om [din/kom]
				
<b>80</b>	002464	100	40 000	<b>144,00</b>
<b>140</b>	002471	100	28 000	<b>180,00</b>
<b>200</b>	002488	100	20 000	<b>223,00</b>
<b>250</b>	002495	100	16 000	<b>245,00</b>
<b>300</b>	002501	100	11 200	<b>245,00</b>

CINKOTIT

## TIPL M10

P-POB-HN DB





Nominalna veličina	EAN broj proizvoda	Pakovanje u kom		Cena sa PDV-om [din/kom]
				
<b>120</b>	002426	100	25 000	<b>58,00</b>

## LAMELNI TIPL M10

P-POB-HN DB





Nominalna veličina	EAN broj proizvoda	Pakovanje u kom		Cena sa PDV-om [din/kom]
				
<b>180</b>	002433	100	12 000	<b>60,00</b>
<b>240</b>	002440	100	12 000	<b>72,00</b>
<b>280</b>	002457	100	12 000	<b>76,00</b>

## KOMBINIRANI VIJAK TORX M10

P-POB-ZT/SZ



Nominalna veličina	EAN broj proizvoda	Pakovanje u kom		Cena sa PDV-om [din/kom]
				
<b>140</b>	002587	50	10 400	<b>65,00</b>
<b>180</b>	002594	50	10 400	<b>79,00</b>



## IZOLACIONI TIPL M10

## P-POB-HN IZOL

Nominalna veličina	EAN broj proizvoda	Pakovanje u kom		Cena sa PDV-om [din/kom]
<b>M10 x 96</b>	001207	25	2 625	<b>389,00</b>



## IZOLACIONI TIPLI VRH CIGLA BEZ IZOLACIJE

## P-POB-HN WDV5140 M10

Nominalna veličina	EAN broj proizvoda	Pakovanje u kom		Cena sa PDV-om [din/kom]
<b>140</b>	144843	1/5	750	<b>691,00</b>



## IZOLACIONI TIPLI VRH CIGLA IZOLACIJA

## P-POB-HN WDV5300 M10

Nominalna veličina	EAN broj proizvoda	Pakovanje u kom		Cena sa PDV-om [din/kom]
<b>300</b>	144850	1/5	500	<b>1 123,00</b>



## UNI PLATFORMA OD NERĐAJUĆEG ČELIKA ZA PRIČVRŠĆIVANJE OB M10 P-POB-HN PLAT M10

Nominalna veličina	EAN broj proizvoda	Pakovanje u kom		Cena sa PDV-om [din/kom]
<b>M10</b>	144836	25/500	5 000	<b>482,00</b>

## NAVOJNA ŠIPKA M10

P-POB-ZT



Nominalna veličina	EAN broj proizvoda	Pakovanje u kom		Cena sa PDV-om [din/kom]
60	002556	100	20 800	29,00
100	002563	100	15 600	43,00
150	002570	50	10 400	79,00

## MONTAŽNA PLOČICA M10

P-POB-ZT MP



Nominalna veličina	EAN broj proizvoda	Pakovanje u kom		Cena sa PDV-om [din/kom]
80 x 30	002518	25	5 200	166,00

## KAPA ZA ŠELNU

P-POB-HT AKG



Nominalna veličina	EAN broj proizvoda	Pakovanje u kom		Cena sa PDV-om [din/kom]
29 x 13	002280	50	16 800	36,00
29 x 13	002211	50	16 800	36,00
29 x 13	002235	50	16 800	36,00
29 x 13	002266	50	16 800	36,00
29 x 13	002242	50	16 800	36,00
29 x 13	002228	50	16 800	36,00
29 x 13	002273	50	16 800	36,00
29 x 13	002259	50	16 800	36,00
29 x 13	002297	50	16 800	36,00





## ZADRŽAČ VODE

TZ-TZZV



Nominalna veličina	EAN broj proizvoda	Pakovanje u kom		Cena sa PDV-om [din/kom]
80	035011	6	180	<b>1 526,00</b>
100	035028	5	150	<b>1 872,00</b>
120	035035	3	90	<b>2 390,00</b>

## ZADRŽAČ VODE SA SITOM

TZ-TZZVS



Nominalna veličina	EAN broj proizvoda	Pakovanje u kom		Cena sa PDV-om [din/kom]
80	034984	6	180	<b>1 872,00</b>
100	034991	5	150	<b>2 146,00</b>
120	035004	3	90	<b>3 600,00</b>

## ZADRŽAČ VODE SA CREVOM

TZ-TZZVHA



Nominalna veličina	EAN broj proizvoda	Pakovanje u kom		Cena sa PDV-om [din/kom]
80	001450	1	60	<b>8 640,00</b>
120	001474	1	60	<b>14 256,00</b>

## ZADRŽIVAČ VODE SA CREVOM I DUGMETOM

TZ-TZZVHAG



Nominalna veličina	EAN broj proizvoda	Pakovanje u kom		Cena sa PDV-om [din/kom]
100	001467	1	60	<b>9 072,00</b>



## ZAŠTITNA ODVODNA CEV SA REVIZIONIM OTVOROM

P-POZR

Nominalna veličina	Dužina u m	EAN broj proizvoda	Pakovanje u kom		Cena sa PDV-om [din/kom]
80	1,0	009708	1	70	8 640,00
100	1,0	009715	1	60	6 480,00
100	1,5	009722	1	60	12 816,00



## ZAŠTITNA ODVODNA CEV SA REVIZIONIM OTVOROM

P-POZR

Nominalna veličina	Dužina u m	EAN broj proizvoda	Pakovanje u kom		Cena sa PDV-om [din/kom]
120	1,0	009739	1	40	15 120,00
120	1,5	009746	1	40	20 592,00

CINKOTIT

## ŠELNA SA GUMOM M10

P-POB-OZR



Nominalna veličina	EAN broj proizvoda	Pakovanje u kom		Cena sa PDV-om [din/kom]
80	002525	25	1 250	223,00
100	002532	25	1 250	288,00
120	002549	20	1 000	324,00

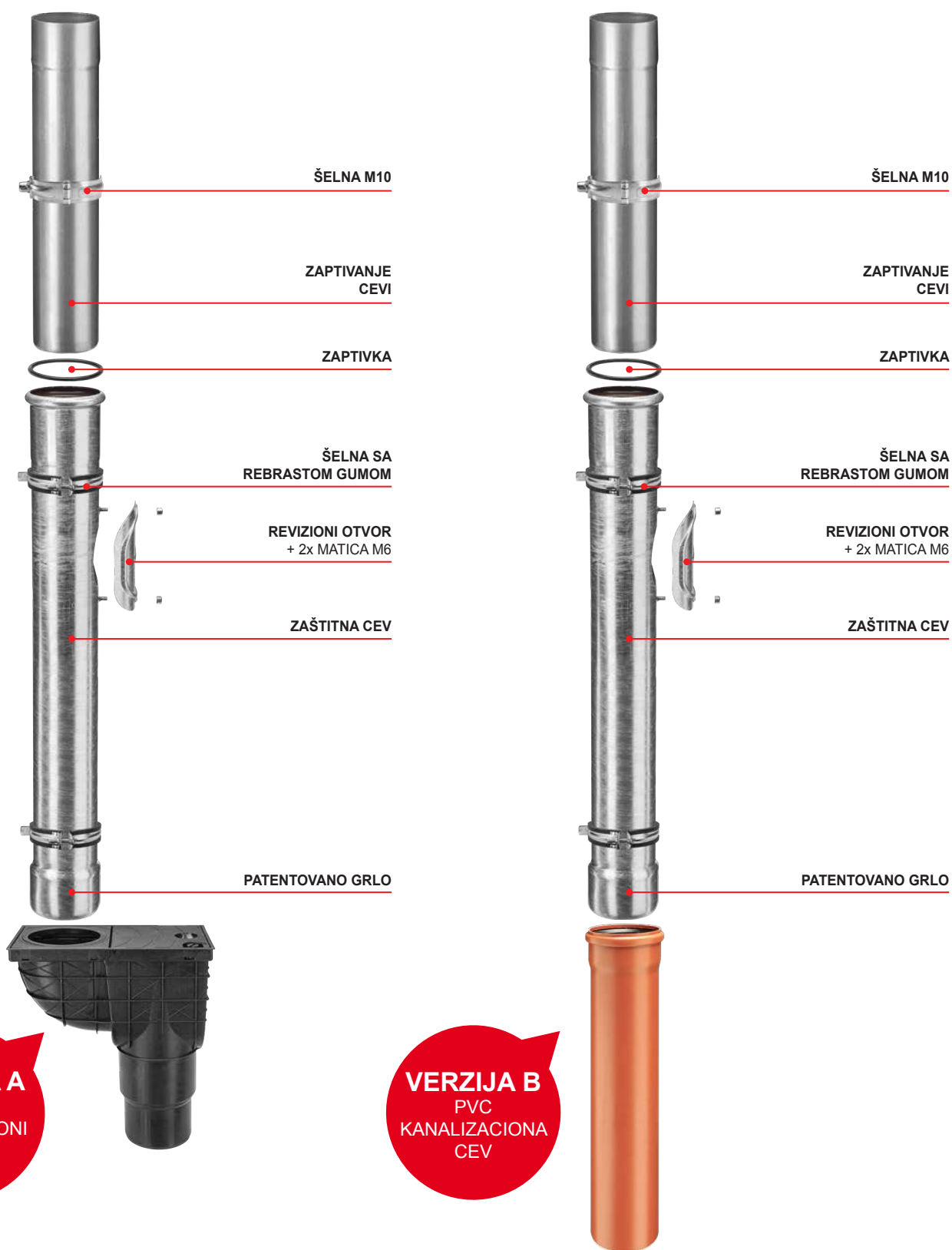

**VERZIJA A**  
PVC  
KANALIZACIONI  
ULAZ

**VERZIJA B**  
PVC  
KANALIZACIONA  
CEV

CINKOTIT

